

Robust Multi-Objective PQ Scheduling for Electric Vehicles in Flexible Unbalanced Distribution Grids

Katarina Knezović^{1,*}, Alireza Soroudi², Andrew Keane², Mattia Marinelli¹

¹Centre for Electric Power and Energy, Department of Electrical Engineering, Technical University of Denmark, Denmark

²School of Electrical and Electronic Engineering, University College Dublin, Dublin, Ireland

*kknez@elektro.dtu.dk

Abstract: With increased penetration of distributed energy resources and electric vehicles (EVs), different EV management strategies can be used for mitigating adverse effects and supporting the distribution grid. This paper proposes a robust multi-objective methodology for determining the optimal day-ahead EV charging schedule while complying with unbalanced distribution grid constraints. The proposed methodology considers partially competing objectives of an EV aggregator and the respective distribution system operator, and applies a fuzzy-based mechanism for obtaining the best compromise solution. The robust formulation effectively considers the errors in the electricity price forecast and its influence on the EV schedule. Moreover, the impact of EV reactive power support on objective values and technical parameters is analysed both when EVs are the only flexible resources and when linked with other demand response programs. The method is tested on a real Danish unbalanced distribution grid with 35% EV penetration to demonstrate the effectiveness of the proposed approach. It is shown that the proposed formulation guarantees an optimal EV cost as long as the price uncertainties are lower than the aggregator's conservativeness degree, and that EV reactive power improves local conditions without significantly affecting the EV cost.

Nomenclature

Sets and Indices

ϕ Set of phases {a,b,c}.

i, j Index for bus i,j.

l Set of distribution lines.

t Set of time intervals.

Parameters

$(P/Q)_{0,i}^{\phi D}$ Nominal active/reactive power of demand connected to bus i on phase ϕ .

$\Delta_t^{-/+}$ Negative/positive electricity price deviation at time t .

$\eta_{ch,i}^{\phi, EV}$ Charging efficiency of an EV connected to bus i on phase ϕ .

Γ Conservativeness degree of the decision maker with respect to price uncertainty.

$\lambda_t^{f/a}$ Forecasted/actual electricity price at time t .

$\lambda_t^{min/max}$ Minimum/maximum electricity price bound at time t .

$|V_{i,t,min/max}^{\phi}|$ Minimum/maximum acceptable voltage magnitude of phase ϕ at bus i at time t .

$|Y_{ij}^{\phi_1\phi_2-n}|$ Admittance magnitude between phase ϕ_1 at bus i and phase ϕ_2 at bus j of branch ij .

$\bar{\lambda}_t$ Uncertain electricity price at time t .

$\theta_{ij}^{\phi_1\phi_2}$ Admittance angle between phase ϕ_1 at bus i and phase ϕ_2 at bus j of branch ij .

$\varphi_{i,t}^{\phi D}$ Power factor of demand connected to bus i on phase ϕ at time t .

ξ_i Demand flexibility parameter for bus i .

$k_i^{\phi EV}$ Converter parameter for reactive power control of an EV connected to bus i on phase ϕ .

$P_{i,max}^{\phi}$ Maximum active power of an EV connected to bus i on phase ϕ .

$Q_{i,min/max}^\phi$ Minimum/maximum reactive power of an EV connected to bus i on phase ϕ .

$S_{ij,max}^\phi$ Maximum apparent power on phase ϕ of branch ij .

$SOC_{0/max,i,t}^{\phi EV}$ Initial/maximum state of charge of an EV connected to bus i on phase ϕ at time t .

$t_{start/end,i}^{\phi EV}$ Arrival/departure time of an EV connected to bus i on phase ϕ at time t .

Variables

$(P/Q)_{i,t}^{\phi Dnew}$ Active/reactive power of demand connected to bus i on phase ϕ at time t .

$(P/Q)_{i,t}^{\phi EV}$ Active/reactive power of an EV connected to bus i on phase ϕ at time t .

$(P/Q)_{i,t}^{\phi G}$ Active/reactive power of a generating unit connected to bus i on phase ϕ at time t .

β, ω_t, Θ Auxiliary variables.

δ_i^ϕ Voltage angle of phase ϕ at bus i .

$|V_{i,t}^\phi|$ Voltage magnitude of phase ϕ at bus i at time t .

$P_{0,i,t}^{\phi EV}$ Active power of an EV connected to bus i on phase ϕ at time t at nominal voltage conditions.

$SOC_{i,t}^{\phi EV}$ State of charge of an EV connected to bus i on phase ϕ at time t .

1. Introduction

Fundamental changes occurring in the electric power system promoted by the global sustainability efforts are reshaping the electrical grid operation. With increased penetration of distributed energy resources, there is an additional need for control strategies which allow them to provide various flexibility services and avoid over-investments for maintaining the grid security [1]. Additionally, since the market share of electric vehicles (EVs) is expected to grow significantly in the following years, even greater system complexity is imposed [2]. Uncontrolled EV charging may result in voltage violations and cable overloading followed by the need for grid reinforcement, but also in increased operational cost due to increased energy losses. As an economic alternative, different EV charging strategies can be used for mitigating the adverse effects and supporting the grid.

11 An extensive amount of research has been made on coordinated EV charging proving that such
12 concept can be used for lowering the undesired impacts on the power system and providing ancil-
13 lary services [3–5]. A new business entity, namely EV aggregator, has been widely proposed to
14 coordinate large EV amounts and offer their services to system operators via centralised control
15 which is proven to reduce losses, improve voltage stability and decrease peak loading compared
16 to the uncontrolled case. Various studies use optimal power flow formulation for EV scheduling
17 in order to minimise the charging cost or maximise the EV aggregator revenue [6, 7], but they
18 usually deal with large EV numbers at the transmission level and completely omit distribution grid
19 constraints. In a smart grid context, obtaining an optimal EV charging schedule requires an ade-
20 quate grid representation since results must be feasible in the respective grid with corresponding
21 constraints [8–10]. In addition to EV active power scheduling, EV reactive power can also be used
22 to support the distribution grid. Compared to traditional voltage regulation means in distribution
23 grids such as capacitor banks and on-load tap changers [11], EV reactive power capability can
24 provide dynamic, continuous and distributed support as well as inductive reactive power support if
25 and where needed. For instance, autonomous reactive power support based on droop control has
26 been investigated in [12, 13], but the approaches do not provide any optimal scheduling. Moreover,
27 even though they are cost-effective, active and reactive power droop controllers may cause unde-
28 sirable avalanche effects of simultaneous reactions [14]. So, more advanced methods with direct
29 communication to service providers are needed to unleash the full demand response potential, in-
30 cluding EVs [15]. Ref. [16] presents a PQ optimisation method for EV (dis)charging, but focuses
31 only on the total charging cost, whereas distribution grid constraints have been completely disre-
32 garded. These constraints have been taken into account in [17, 18], but only for balanced systems.
33 Similarly, [19, 20] deal with robust EV scheduling, but they either disregard the distribution grid
34 constraints or only consider balanced conditions.

35 As pointed out in [3], combining several objective functions in EV scheduling has scarcely
36 been touched upon, even though combining both DSO's and EV aggregator's concern is of ut-
37 ter importance. In [21], the proposed multi-objective framework combines minimisation of EV
38 charging cost and minimisation of reactive power insufficiency, but specific power system results

39 are not presented, and it remains unclear if the framework is applicable to unbalanced systems.
40 Ref. [22] proposes a multi-objective formulation at the distribution level for minimising operation
41 cost and voltage deviations, but it is applicable only to balanced grids. Since distribution systems
42 are usually unbalanced and EVs are single-phase connected, the individual EV charging schedules
43 do not have to coincide for all vehicles, especially in heavily unbalanced networks. Hence, using
44 unbalanced optimal power flow is essential in order to accurately represent the distribution system
45 and the unbalance effect on the operation schedules. In [23], unbalanced constraints are taken into
46 account, but the impact of electricity price uncertainty is disregarded.

47 Even though EV smart charging problem is well studied and numerous approaches are proposed
48 for achieving this behaviour, many existing methods suffer from one or more of the following draw-
49 backs: (1) lack of distribution grid constraints, (2) optimal power flow formulation for balanced
50 grids, (3) no EV reactive power flexibility, (4) no multi-objective formulation for collaborative EV
51 scheduling between the DSO and the EV aggregator, and (5) disregarding the uncertainties asso-
52 ciated to the electricity price. To the authors' knowledge, the existing research has not looked into
53 combining all of the mentioned aspects together. The contributions of this paper are as follows:

- 54 • To propose a novel model for obtaining a combined EV active and reactive power day-ahead
55 schedule considering unbalanced distribution grid constraints. Using the unbalanced optimal
56 power flow allows to schedule the individual EVs with respect to the constraints of the phase
57 they are connected to.
- 58 • To propose a novel model with a multi-objective formulation which combines two partially
59 competing objectives: minimisation of the DSO's losses which represent the local grid effi-
60 ciency, and minimisation of EV aggregator's charging cost which represent the system-wide
61 aspect as the EV aggregator participates in the wholesale electricity market. The methodol-
62 ogy provides not only one solution, but a set of solutions from which an optimal schedule can
63 be chosen with a proper balance between the DSO's and EV aggregator's concerns.
- 64 • To consider the uncertainty in electricity price which influences EV charging costs. By using
65 the robust optimisation technique, it is guaranteed that EV schedules remain acceptable if the

66 actual electricity price deviates from the forecasted value to a certain conservativeness degree
67 defined by the EV aggregator.

- 68 • To analyse the impact of EV reactive power support both on technical parameters and on EV
69 charging cost in case when EVs are the only flexible resource and when interconnected with
70 other demand response.

71 **2. Problem formulation and modelling**

72 *2.1. Assumptions*

73 The assumptions of this paper are described as follows:

- 74 • All EVs are under the jurisdiction of a single EV aggregator who entered into a contract
75 with individual EV owners, knows their connection points and uses estimation techniques for
76 predicting EV arrival and departure times to manage the scheduling. EVs are equipped with
77 smart metering technology and can be remotely controlled by receiving the active/reactive
78 power charging set point. It is also assumed that EV users are not interested in how and when
79 the vehicles are charged as long as they are fully available by the estimated departure time
80 which remains true as long as the aggregator remunerates all users in the same manner. The
81 specific way the aggregator chooses to remunerate the users is beyond the scope of this paper.
- 82 • Grid operator has access to the following information: network size, network topology, line
83 specifications and transformer specifications. Smart metering technology with load control
84 capability is assumed to be present in each household and can be used for rescheduling part
85 of the consumption through demand response program [1, 24].
- 86 • DSO and EV aggregator utilise techniques for forecasting the day-ahead electricity price with
87 the respective uncertainty bounds, as well as the consumption which can be forecasted with
88 reasonable accuracy. Therefore, the error associated with the load forecast and user behaviour
89 has been disregarded.
- 90 • Similarly to available PV inverters, the 4-quadrant EV converter can be enabled to exchange

91 reactive power with the grid without affecting the state-of-charge and consequently user com-
 92 fort. It is assumed that EV converters are sized to provide reactive power additionally to the
 93 active power charging rate with no need for curtailing the active power [12, 13]. Similar PV
 94 inverters are already commercially available due to grid codes in several European countries.

95 2.2. Constraints

96 In this work, a three-phase grounded four-wire system optimal power flow is formulated based
 97 on [25] and implemented as a single non-linear program which can be solved by commercial
 98 non-linear solvers such as CONOPT or IPOPT. Within this formulation, the calculated active and
 99 reactive power for phase a of branch ij at time t are given as follows:

$$P_{ij,t}^a = \sum_{\phi=a,b,c} \left(|V_{i,t}^a| |Y_{ij}^{a\phi-n}| |V_{i,t}^\phi| \cos(\theta_{ij}^{a\phi} + \delta_{i,t}^\phi - \delta_{i,t}^a) - |V_{i,t}^a| |Y_{ij}^{a\phi-n}| |V_{j,t}^\phi| \cos(\theta_{ij}^{a\phi} + \delta_{j,t}^\phi - \delta_{i,t}^a) \right) \quad (1)$$

$$Q_{ij,t}^a = \sum_{\phi=a,b,c} \left(|V_{i,t}^a| |Y_{ij}^{a\phi-n}| |V_{j,t}^\phi| \sin(\theta_{ij}^{a\phi} + \delta_{j,t}^\phi - \delta_{i,t}^a) - |V_{i,t}^a| |Y_{ij}^{a\phi-n}| |V_{i,t}^\phi| \sin(\theta_{ij}^{a\phi} + \delta_{i,t}^\phi - \delta_{i,t}^a) \right) \quad (2)$$

100 Similar equations can be extracted for active and reactive power of the remaining two phases b and
 101 c . The power mismatch equations for each bus are given as follows:

$$\sum_{\substack{j=1 \\ j \neq i}}^{N_j} P_{ij,t}^\phi = \sum_{G=1}^{N_G} P_{i,t}^{\phi G} - \sum_{D=1}^{N_D} P_{i,t}^{\phi Dnew} - \sum_{EV=1}^{N_{EV}} P_{i,t}^{\phi EV} \quad (3)$$

$$\sum_{\substack{j=1 \\ j \neq i}}^{N_j} Q_{ij,t}^\phi = \sum_{G=1}^{N_G} Q_{i,t}^{\phi G} - \sum_{D=1}^{N_D} Q_{i,t}^{\phi Dnew} - \sum_{EV=1}^{N_{EV}} Q_{i,t}^{\phi EV} \quad (4)$$

102 The voltage dependency of residential demand is given by equation (5) where $P_{0,i}^{\phi D}$ and $Q_{0,i}^{\phi D}$ rep-
 103 resent the load's nominal active and reactive power, respectively, whereas κ equals to zero for
 104 constant power loads, one for constant current loads or two for constant impedance loads. Further-
 105 more, residential consumption is assumed to be somewhat flexible, so the load may vary within the

106 observed period as described by equation (6) and equation (7). The load's reactive power is then
 107 given by equation (8).

$$P_{i,t}^{\phi D} = P_{0,i}^{\phi D} \cdot |V_{i,t}^{\phi}|^{\kappa} \quad (5)$$

$$\sum_t P_{i,t}^{\phi Dnew} \cdot |V_{i,t}^{\phi}|^{\kappa} = \sum_t P_{0,i}^{\phi D} \cdot |V_{i,t}^{\phi}|^{\kappa} \quad (6)$$

$$(1 - \xi_i)P_{0,i}^{\phi D} \leq P_{i,t}^{\phi Dnew} \leq (1 + \xi_i)P_{0,i}^{\phi D} \quad (7)$$

$$Q_{i,t}^{\phi Dnew} = \tan(\arccos(\varphi_{i,t}^{\phi D})) \cdot P_{i,t}^{\phi Dnew} \cdot |V_{i,t}^{\phi}|^{\kappa} \quad (8)$$

108 The distribution grid voltage and power flow constraints are formulated as follows:

$$V_{i,t,min}^{\phi} \leq |V_{i,t}^{\phi}| \leq V_{i,t,max}^{\phi} \quad (9)$$

$$(P_{ij,t}^{\phi})^2 + (Q_{ij,t}^{\phi})^2 \leq (S_{ij,max}^{\phi})^2 \quad (10)$$

109 where $S_{ij,max}^{\phi}$ is the maximum apparent power capacity of branch ij . In addition, the MV side of
 110 the transformer is assumed to be the slack bus with fixed voltage magnitudes and angles.

111 EV characteristics are expressed using the following constraints:

$$SOC_{i,t}^{\phi EV} = SOC_{i,t-1}^{\phi EV} + P_{i,t}^{\phi EV} \cdot \Delta t \cdot \eta_{ch,i}^{\phi EV} \quad (11)$$

$$SOC_{0,i}^{\phi EV} \leq SOC_{i,t}^{\phi EV} \leq SOC_{i,max}^{\phi EV} \quad (12)$$

$$SOC_{i,t|t=t_{end}}^{\phi EV} = SOC_{i,max}^{\phi EV} \quad (13)$$

$$P_{i,t}^{\phi EV} = P_{0,i,t}^{\phi EV} \cdot |V_{i,t}^{\phi}| \quad (14)$$

$$0 \leq P_{0,i,t}^{\phi EV} \leq P_{i,max}^{\phi EV} \quad (15)$$

$$-k_{i,t}^{\phi EV} \cdot P_{i,t}^{\phi EV} \leq Q_{i,t}^{\phi EV} \leq k_{i,t}^{\phi EV} \cdot P_{i,t}^{\phi EV} \quad (16)$$

$$Q_{i,min}^{\phi EV} \leq Q_{i,t}^{\phi EV} \leq Q_{i,max}^{\phi EV} \quad (17)$$

112 Equation (11) describes EV state of charge (SOC) dependent on the SOC in the previous time
 113 step, EV charging power and EV charging efficiency, whereas the battery size constraint is given

114 by equation (12). Equation (13) imposes the restriction where EVs must be fully charged before
 115 the estimated departure time to ensure they are fully available for primary transportation purposes.
 116 As represented in equation (14), EVs are modelled as a constant current load with $\kappa = 1$ [26,27]
 117 where $P_{0,i,t}^{\phi EV}$ represents the EV active power value at nominal voltage conditions. In addition to
 118 EV active power constraints described in equation (15), it is assumed that EVs have the possi-
 119 bility to dynamically modulate the power factor under constraints described in equation (16) and
 120 equation (17). $k_{i,t}^{\phi EV}$ is fixed for each EV converter, e.g., $k_{i,t}^{\phi EV} = 1/3$ for a converter capable of
 121 modulating the power factor up to 0.95 (*ind./cap.*).

122 2.3. Nominal optimisation problem

123 The proposed methodology obtains an optimal EV active and reactive schedule considering two
 124 partially competing objective functions which combine both the DSO's and the EV aggregator's
 125 concerns in one multi-objective model. The first objective is minimising the operating cost in terms
 126 of energy losses [28] which represents one of the main DSO concerns. The minimisation of energy
 127 losses f_1 can be formulated as:

$$\min f_1 = \sum_t \sum_{l=1}^{N_l} \sum_{\phi=a,b,c} P_{l,t}^{\phi loss} = \sum_t \sum_i^{N_i} \sum_j^{N_j} \sum_{\phi=a,b,c} (P_{ij,t}^{\phi} + P_{ji,t}^{\phi}) \quad (18)$$

128 where $P_{l,t}^{\phi loss}$ are the total losses on phase ϕ of line l .

129 The second objective function is minimising the total EV charging cost since it is assumed that
 130 the aggregator enters into a contract with individual EV owners. Then, this function represents the
 131 aggregator's main concern as by minimising the total charging cost, it maximises the revenue. The
 132 minimisation of EV charging cost f_2 can be formulated as:

$$\min f_2 = \sum_t \sum_{EV=1}^{N_{EV}} \sum_{\phi=a,b,c} P_{i,t}^{\phi EV} \lambda_t \quad (19)$$

133 Assuming that $F(\mathbf{DV}, \Pi)$ is the vector of objective functions where \mathbf{DV} represents decision vari-
 134 ables and Π represents input parameters, whereas $H(\mathbf{DV}, \Pi)$ and $G(\mathbf{DV}, \Pi)$ represent equality

135 and inequality constraints, respectively, the proposed multi-objective minimisation problem can
 136 generally be formulated as follows:

$$\begin{aligned}
 & \underset{\mathbf{DV}}{\text{minimise}} && F(\mathbf{DV}, \Pi) = [f_1(\mathbf{DV}, \Pi), f_2(\mathbf{DV}, \Pi)] \\
 & \text{subject to:} && \{G(\mathbf{DV}, \Pi) = 0, H(\mathbf{DV}, \Pi) \leq 0\}
 \end{aligned} \tag{20}$$

137 For solving the multi-objective problem and obtaining the Pareto optimal front, ϵ -constraint method
 138 is used due to several advantages [29], e.g., it can be used for both convex and non-convex Pareto
 139 optimal sets, it does not require scaling of the objective functions which can influence the results,
 140 and it needs less iterations for the front discovery compared to the weighted-sum method where
 141 several weight combinations can result in the same solution. The ϵ -constraint method involves min-
 142 imising the primary objective function while expressing the other objective in a form of inequality
 143 constraint. Equation (20) can then be reformulated as follows:

$$\begin{aligned}
 & \underset{\mathbf{DV}}{\text{minimise}} && f_2(\mathbf{DV}, \Pi) \\
 & \text{subject to:} && \{G(\mathbf{DV}, \Pi) = 0, H(\mathbf{DV}, \Pi) \leq 0\} \\
 & && f_1(\mathbf{DV}, \Pi) \leq \epsilon
 \end{aligned} \tag{21}$$

144 where ϵ varies from the maximum to the minimum value of f_1 .

145 After obtaining all Pareto points and in case the front is non-convex, it is necessary to compare
 146 individual solutions and exclude the dominated ones (local Pareto points) from the frontier.

147 *2.4. Uncertainty modelling*

148 There are several techniques for modelling the price uncertainty including stochastic scenario mod-
 149 elling, fuzzy modelling , Info-gap decision theory and robust optimisation [30]. In this work, ro-
 150 bust optimisation is used to handle the uncertainties which are defined as an interval around the
 151 forecasted value. The idea of robust optimisation is to minimise the objective function without
 152 knowing the exact electricity price value, but only its minimum and maximum bounds. Such in-
 153 tervals are usually obtained using time-series models (ARIMA), neural networks and historic data

154 [31]. Hence, the uncertain electricity price is formulated as follows:

$$\bar{\lambda}_t \in U(\bar{\lambda}_t) = \left\{ \bar{\lambda}_t : \lambda_t^{min} \leq \bar{\lambda}_t \leq \lambda_t^{max} \right\} \quad (22)$$

155 where λ_t^{min} and λ_t^{max} are the lower and upper bounds of $\bar{\lambda}_t$, respectively.

156 Optimal decision making is done so that the obtained solution remains good if the actual electricity
 157 price λ_t^a deviates from the forecasted value λ_t^f to some degree Γ . Ref. [32] proves that the robust
 158 solution will be feasible with high probability even when more than Γ forecasting errors occur.
 159 In case the actual electricity price is higher than the forecasted value, constraints for uncertainty
 160 modelling can be expressed as equation (23). Similarly, in case the electricity price is lower than
 161 the forecasted value, constraints in equation (24) apply. As the decision maker seeks the robust-
 162 ness against undesired events, equation (24) is not considered as an issues, so the main concern
 163 remains the case when the electricity price is higher than the forecasted values, as formulated in
 164 equation (23).

$$\begin{aligned} \lambda_t^a &= \lambda_t^f + \Delta_t^+ \omega_t \\ \Delta_t^+ &= \lambda_t^{max} - \lambda_t^f \\ 0 &\leq \omega_t \leq 1 \end{aligned} \quad (23)$$

165

$$\begin{aligned} \lambda_t^a &= \lambda_t^f + \Delta_t^- \omega_t \\ \Delta_t^- &= \lambda_t^{min} - \lambda_t^f \\ 0 &\leq \omega_t \leq 1 \end{aligned} \quad (24)$$

166 **2.5. Robust optimisation formulation**

167 Taking price uncertainty into consideration, the objective function formulated in (19) becomes:

$$\underset{\mathbf{DV}}{\text{minimise}} \quad f_2(\mathbf{DV}, \Pi, \bar{\lambda}_t) = \sum_t \sum_{EV=1}^{N_{EV}} \sum_{\phi=a,b,c} \left(P_{i,t}^{\phi EV} \lambda_t^f + P_{i,t}^{\phi EV} \Delta_t^+ \omega_t \right) \quad (25a)$$

$$0 \leq \omega \leq 1 \quad (25b)$$

$$\sum_t \omega_t \leq \Gamma \quad (25c)$$

$$\text{subject to:} \quad (1) \text{ to } (17) \quad (25d)$$

$$f_1(\mathbf{DV}, \Pi) \leq \epsilon \quad (25e)$$

168 Here, Γ is a parameter specified by the decision maker which is introduced to prevent too conser-
 169 vative solutions [32]. More precisely, it denotes the maximum total deviation that can be tolerated.
 170 Γ can vary from 0 (meaning no uncertainty may happen) to 24 (all uncertain parameters may take
 171 their worst value). The higher the Γ , the more conservative the decision maker is. One should note
 172 how for $\Gamma = 0$, the robust problem converts into the nominal one. In order to find the worst case
 173 condition of price uncertainty that would cause the maximum increase in EV cost, it is necessary
 174 to formulate the robust counter part of equation (25) as follows [33]:

$$\underset{\mathbf{DV}}{\text{minimise}} \quad f_2(\mathbf{DV}, \Pi, \bar{\lambda}_t) = \sum_t \sum_{EV=1}^{N_{EV}} \sum_{\phi=a,b,c} \left(P_{i,t}^{\phi EV} \lambda_t^f + \max_{\omega_t} \left\{ \begin{array}{l} P_{i,t}^{\phi EV} \Delta_t^+ \omega_t \\ \text{s.t: (25b), (25c)} \end{array} \right\} \right) \quad (26a)$$

$$\text{subject to:} \quad (1) \text{ to } (17) \quad (26b)$$

$$f_1(\mathbf{DV}, \Pi) \leq \epsilon \quad (26c)$$

175 This formulation requires to solve a bi-level optimisation problem which can, according to the
 176 duality gap theory [33], be transformed into:

$$\underset{\mathbf{DV}}{\text{minimise}} \quad f_2(\mathbf{DV}, \Pi, \bar{\lambda}_t) = \sum_t \sum_{EV=1}^{N_{EV}} \sum_{\phi=a,b,c} P_{i,t}^{\phi EV} \lambda_t^f + \sum_t \beta_t + \Gamma \Theta \quad (27a)$$

$$\Theta + \beta_t \geq (\lambda_t^{max} - \lambda_t^f) \cdot \sum_{EV=1}^{N_{EV}} \sum_{\phi=a,b,c} P_{i,t}^{\phi EV} \quad (27b)$$

$$\Theta, \beta_t \geq 0 \quad (27c)$$

$$\text{subject to:} \quad (1) \text{ to } (17) \quad (27d)$$

$$f_1(\mathbf{DV}, \Pi) \leq \epsilon \quad (27e)$$

177 We remark that the obtained single level optimisation in equation (27) can also be applied to other
 178 scenarios with different sources of uncertainty. For instance, price deviations can be formulated to
 179 represent the error associated to load uncertainty or EV availability [34].

180 2.6. Best compromise solution

181 Once the Pareto optimal front is determined, a range of solutions is available between which the
 182 final operating schedule should be chosen. Here, a fuzzy satisfying set theory is used to choose
 183 the best candidate solution. The concept can be described as follows: for each solution X_n in the
 184 Pareto optimal front with N_s solutions, a membership function $\mu_k(X_n)$ is defined to show the level
 185 of which X_n belongs to the set that minimises the objective function f_k . A linear membership
 186 function is used for both objective functions as follows:

$$\forall k \in \{1, 2\} \mu_k(X_n) = \begin{cases} 0, & f_k(X_n) > f_{kmax} \\ \frac{f_{kmax} - f_k(X_n)}{f_{kmax} - f_{kmin}}, & f_{kmin} \leq f_k(X_n) \leq f_{kmax} \\ 1, & f_k(X_n) < f_{kmin} \end{cases} \quad (28)$$

187 where f_{kmin} is the minimum, and f_{kmax} is the maximum value of objective f_k .

188 The best compromise solution is then determined by the decision maker. A conservative deci-

189 sion maker tries to minimise the maximum dissatisfaction for all objectives [35], i.e., to maximise
 190 the satisfaction of both the DSO and the EV aggregator. Hence, the final best compromise solution
 191 can be found as:

$$\max_{N_S} \left(\min_{k=1}^2 (\mu_k(X_n)) \right) \quad (29)$$

192 By using this criteria, it could be interesting for the decision maker to arrange the Pareto solutions
 193 in a descending order, and obtain a priority list of possible schedules. In case the DSO is not
 194 interested in the best possible solution, but only requires EV schedules for which the losses are
 195 below a certain threshold, the robust multi-objective problem (27) is solved for a fixed value of ϵ .

196 3. Test Case

197 3.1. Distribution grid

198 The proposed methodology is tested on a real semi-urban low-voltage distribution grid located in
 199 Zealand, Denmark, which is modelled based on the information and measurement data provided
 200 by a Danish DSO [13]. The described optimisation model is applied to a feeder which is radially
 201 run and connected to the 10 kV MV network through a typical 400 kVA distribution transformer
 202 with the assumption that the voltages of the MV slack bus are kept at 1 *p.u.*, so $\pm 10\%$ U_n is
 203 completely available for LV regulation ($V_{i,t,min}^\phi = 0.9 U_n$, $V_{i,t,max}^\phi = 1.1 U_n$). As seen in Fig. 1, the
 204 observed feeder has 43 residential houses which are three-phase connected with the nominal phase-
 205 to-neutral voltage $U_n = 230$ V. The feeder is composed of 13 line segments between 25 m and 112
 206 m in length, all of the same cable type with $X/R = 0.37$. This corresponds to typical LV grid
 207 parameters, e.g., similar to the ones of the CIGRE European LV benchmark network [36]. There
 208 are three additional feeders under the same transformer station which have been modelled as an
 209 aggregated load due to the lack of data for individual households. All houses in the observed feeder
 210 are equipped with smart meters, so individual consumption profiles are based on real metering data
 211 with an hourly sampling rate. Consumption values are based on three-phase measurements with
 212 no insight into individual phase fractions, so, based on the DSO's experience, it is assumed that
 213 the phase unbalance is distributed in 40%:30%:30% ratio. Additionally, the measured data does

214 not contain the reactive power component, so a fixed power factor of $\cos \varphi = 0.95$ (*ind.*) has
 215 been considered for all households based on the DSO's recommendation. The residential demand
 response flexibility parameter ξ_i is assumed to be 10% for all nodes.

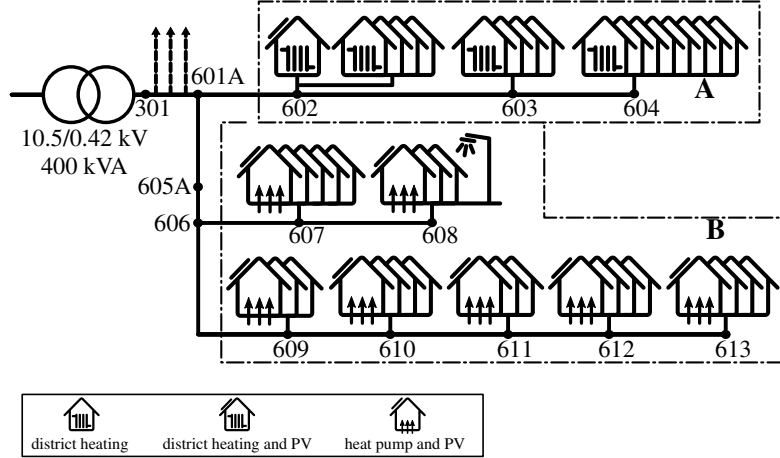

Fig. 1: Schematic overview of the network topology.

216

217 A characteristic 24-h period has been chosen based on the available historic data to represent the
 218 extreme case: a winter day with high residential consumption and almost no PV production. One
 219 should note that the chosen period is from 15/01/2013 12:00 until 16/01/2013 11:00 in order to
 220 include the night time when EVs are generally available. However, other time windows can be
 221 chosen as well. The forecasted electricity price and respective uncertainty range are shown in
 222 Fig. 2. These values can be found using time series models such as ARIMA [31] based on historic
 data.

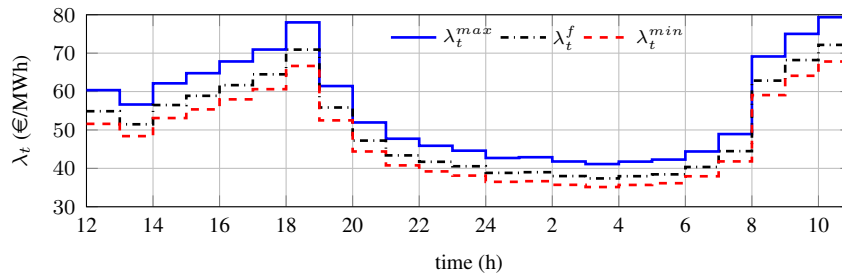

Fig. 2: Forecasted electricity price and uncertainty bounds for the observed 24 hour period.

223

224 3.2. Electric vehicle

225 It is assumed that *Mode 2* charging infrastructure [37] is used for EV charging with a single-phase
 226 16 A connection plug, i.e., 3.7 kW under nominal voltage conditions. For the sake of simplicity, all
 227 EVs are assumed to be a Nissan Leaf with a 24 kWh battery and a constant EV charging efficiency
 228 of 80% [38]. Nevertheless, this assumption does not influence the model's generality as various
 229 vehicle types can easily be included. 15 EVs in total are randomly distributed across the observed
 230 feeder resulting in an overall 35% penetration rate. There are 2 vehicles on phase *a* and 4 on phase
 231 *b* in area A, whereas the distribution in area B is 2 EVs on phase *a*, 3 on phase *b*, and 4 on phase
 232 *c*. The probability of an EV being plugged-in is taken from the data derived in [39], whereas the
 233 initial SOC is taken from the Test-en-EV program where 184 vehicles were distributed to 1600
 234 different Danish families over a three year period [40]. Each vehicle is assigned a random initial
 235 SOC, plug-in time and plug-out time as follows:

$$t_{start,i}^{\phi EV} \sim GEV(17.3, 0.85, -0.06) \quad (30)$$

$$t_{end,i}^{\phi EV} \sim Weibull(7.67, 21.83) \quad (31)$$

$$SOC_{0,i}^{\phi EV} \sim \mathcal{N}(49\%, (4\%)^2) \quad (32)$$

236 Then, $t_{start,i}^{\phi EV}$ and $t_{end,i}^{\phi EV}$ are rounded to the closest integer value as the simulation time step is chosen
 237 to be 1-h due to the available consumption data. One should note how the initial SOC, the arrival
 238 and the departure time are input parameters which are estimated by the EV aggregator. Here,
 239 the generalised extreme value distribution is used for the EV arrival time, whereas the Weibull
 240 distribution is utilised for the departure time. However, the model generality is not influenced by
 241 this choice as other probability distributions can be included as well.

242 Moreover, EV reactive power limits are assumed to be ± 1.23 kVAr which corresponds to
 243 $\cos \phi = 0.95$ (*ind./cap.*) [12]. For comparison, commercially available PV inverters from SMA
 244 Solar Technology have the possibility to modulate the reactive power up to $\cos \phi = 0.8$ (*ind./cap.*).
 245 It is also assumed that EVs can provide reactive power support only if they are charging, so they
 246 cannot act as constant capacitor banks whenever plugged-in. To avoid optimization infeasibility

247 due to EVs with short connection time and low initial SOC, a pre-screening is conducted. More
 248 precisely, if the estimated connection time is lower than the time necessary for dumb charging, it
 249 is assumed there is no active power flexibility from the vehicle. Hence, the charging rate is set
 250 to the nominal value and the corresponding active power variable is excluded from the decision
 251 variables. Yet, EV reactive power remains a decision variable if available.

252 3.3. Scenario overview

253 Five scenarios are defined in order to analyse EV potential for charging cost minimisation and
 254 concurrent grid support.

255 1. *Scenario I*: This case is conducted to provide a basis for comparison between various scenar-
 256 ios. It is assumed that there is no flexibility in the grid ($\xi_i = 0, (P/Q)_{i,t}^{\phi Dnew} = (P/Q)_{0,t}^{\phi D}$),
 257 no optimisation is performed and EVs charge as soon as they are plugged-in until the bat-
 258 tery is completely full ($P_{0,i,t}^{\phi EV} = P_{i,max}^{\phi EV}, Q_{i,t}^{\phi EV} = 0$). The constraint to be satisfied are
 259 (1) to (17), whereas the decision variables are limited to load flow variables, i.e., $\mathbf{DV}_I =$
 260 $\{V_i^{\phi}, \delta_i^{\phi}, (P/Q)_{i,t}^{\phi G}\}$. Since there is no independent decision variable, the objective function
 261 can be chosen as (21) or (27).

262 2. *Scenario II*: The nominal optimisation problem (21) is considered without any price uncer-
 263 tainty and using the optimal scheduling as follows:

- 264 • *Iia*: Multi-objective optimisation is performed by optimising only EV active power under
 265 constraints (1) to (5) and (9) to (15). This implies that $\mathbf{DV}_{IIa} = \mathbf{DV}_I \cup \{P_{i,t}^{\phi EV}\}$.
- 266 • *Iib*: Multi-objective optimisation is performed by optimising both EV active and reactive
 267 power under constraints (1) to (5) and (9) to (17). This implies that $\mathbf{DV}_{IIb} = \mathbf{DV}_{IIa} \cup$
 268 $\{Q_{i,t}^{\phi EV}\}$.
- 269 • *Iic*: Multi-objective optimisation is performed by optimising both EV active and reactive
 270 power combined with other demand response resources under constraints (1) to (17).
 271 This implies that $\mathbf{DV}_{IIc} = \mathbf{DV}_{IIb} \cup \{P_{i,t}^{\phi Dnew}\}$.

272 3. *Scenario III*: The multi-objective optimisation problem (27) is considered with price uncer-

273 tainty and using the optimal scheduling as follows:

- 274 • *IIIa*: The decision variables are the same as in case IIb, i.e., $\mathbf{DV}_{IIIa} = \mathbf{DV}_{IIb}$ under
275 constraints (1) to (5) and (9) to (17).
- 276 • *IIIb*: The decision variables are the same as in case IIc, i.e., $\mathbf{DV}_{IIIb} = \mathbf{DV}_{IIc}$ under
277 constraints (1) to (17).

278 The simulations are done using GAMS software with the commercial CONOPT solver (which is
279 well suited for models with very nonlinear constraints) on a notebook with a 2.6-GHz Intel(R)
280 Core(TM) i7-5600U CPU and 8 GB of RAM, taking in average 6-20 seconds for solving one
281 optimisation problem depending on the conducted scenario. In large scale networks, it would be
282 beneficial to use Benders decomposition techniques [41] or task parallelism. The stop criteria for
283 the optimisation is given as the CONOPT's default tolerance value of 10^{-7} . It is worth noting that
284 the formulated problem is highly non-convex and for such the solver converges to a local optimum
285 which is not necessarily the global one. For Scenarios IIIa and IIIb, the value of Γ represents the
286 conservativeness degree which is set by the decision maker. Simulations have been done for all
287 values of $\Gamma = 0 \rightarrow 24$.

288 4. Simulation Results

- 289 1. *Scenario I*: In case of uncontrolled charging, total EV cost equals to 13.58 € ($\Gamma = 0$) and
290 total daily active losses are 160.66 kWh. The values of possible EV cost for different degrees
291 of uncertainty are given in Table 1. It can be noted how the possible cost would increase
292 from 13.58 € to 20.96 €. The total losses remain the same for all Γ as EV schedules are not
293 controlled.
- 294 2. *Scenario II*: Pareto fronts obtained for the nominal optimisation problem of Scenarios IIa-
295 IIc are given in Fig. 3 with the best compromise solutions emphasised with filled red shape.
296 Foremost, it is obvious that introducing EV reactive power flexibility has beneficial impact
297 on the grid as the Pareto optimal front moves towards the utopia point, which is even more
298 improved in scenario IIc where demand response is added. It is interesting to notice how the

Table 1: Total EV cost (€) versus conservativeness degree (Γ) for the base scenario I and robust scenarios IIIa and IIIb.

| Γ | Scenario I | Scenario III (best compromise) | | Scenario III ($f_1 = \epsilon_{max}$) |
|----------|------------|--------------------------------|------|---|
| | | IIIa | IIIb | IIIb |
| 0 | 13.58 | 8.97 | 9.07 | 8.83 |
| 2 | 14.19 | 9.35 | 9.25 | 9.18 |
| 4 | 14.81 | 9.55 | 9.47 | 9.46 |
| 6 | 15.42 | 9.75 | 9.68 | 9.67 |
| 8 | 16.03 | 9.81 | 9.84 | 9.70 |
| 10 | 16.65 | 9.86 | 9.84 | 9.70 |
| 12 | 17.26 | 9.87 | 9.92 | 9.70 |
| 14 | 17.88 | 9.87 | 9.92 | 9.70 |
| 16 | 18.49 | 9.87 | 9.92 | 9.70 |
| 18 | 19.11 | 9.87 | 9.92 | 9.70 |
| 20 | 19.72 | 9.87 | 9.92 | 9.70 |
| 22 | 20.34 | 9.87 | 9.92 | 9.70 |
| 24 | 20.96 | 9.87 | 9.92 | 9.70 |

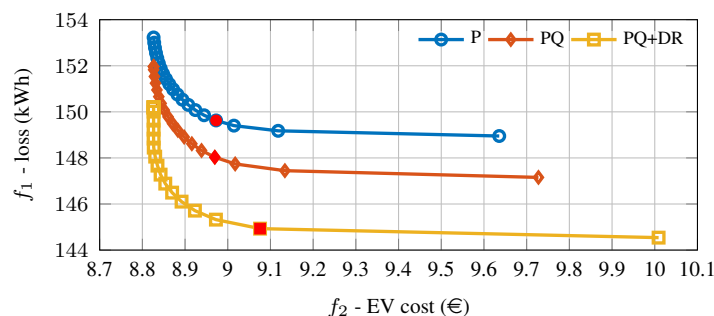

Fig. 3: Obtained Pareto optimal fronts for the nominal optimisation problem in scenarios IIa to IIc ($\Gamma = 0$).

299 maximum EV cost value is increased by adding more flexibility to the system. One of the
300 reasons is EV reactive power dependency on active power. As EV reactive power influences
301 the losses, but it is only available when EVs are charging, the minimum losses are obtained
302 if part of the charging is shifted to more expensive hours when there is a greater need for
303 reactive power support. The objective functions' values for the best compromise solutions of
304 each scenario and the relative values compared to the uncontrolled charging Scenario I are
305 given in Table 2. It can be seen that modulating EV active and reactive power benefits both
306 the DSO and the EV aggregator compared to the uncontrolled case. The influence of EV
307 reactive power flexibility does not have a significant impact on the EV charging cost, whereas
308 it has positive influence on the losses when comparing the best compromise solutions. There-
309 fore, if EV reactive power capability would be obligatory and implemented in grid codes

Table 2: Objective functions' values for Scenario I and the best compromise solutions of scenarios IIa to IIc ($\Gamma = 0$).

| Scenario | EV flexibility | Demand response | EV charging cost (€) | Losses (kWh) | Δ EV charging cost (%) | Δ loss (%) |
|----------|----------------|-----------------|----------------------|--------------|-------------------------------|-------------------|
| I | - | - | 13.58 | 160.66 | - | - |
| IIa | P | - | 8.96 | 149.63 | -34.0 | -6.9 |
| IIb | PQ | - | 8.97 | 148.03 | -33.9 | -7.9 |
| IIc | PQ | $\pm 10\%$ | 9.07 | 145.32 | -33.2 | -8.9 |

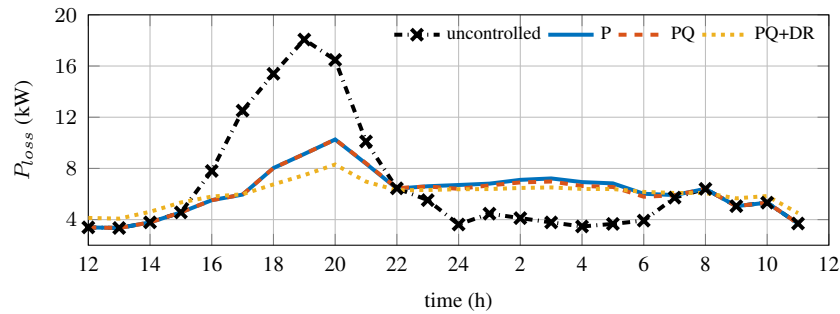

Fig. 4: Active power losses for Scenario I and the best compromise solutions of scenarios IIa to IIc ($\Gamma = 0$).

310 similarly to the ones for PVs, the DSO would have a greater benefit while the EV aggregator,
311 and consequently EV users, would not be substantially affected. Fig. 4 depicts the active
312 power losses for Scenarios IIa-IIc compared to Scenario I where it is easily noticeable that
313 the highest losses are if EVs remain uncontrolled since EV charging coincides with the peak
314 period. For scenarios IIa-IIc, none of the EVs will charge in the peak period as the electricity
315 price is too high. As depicted in Fig. 6a for several individual EVs, active power schedules
316 depend on the EV connection point. Regardless, all EVs charge during the night resulting
317 in a lower peak load and a reduced need for grid reinforcement. Revisiting Fig. 4, it can be
318 seen that losses in the off-peak period diverge for different scenarios since EVs provide local
319 reactive power support. One should bear in mind that higher EV penetrations would impose a
320 higher total consumption, so introducing the local EV reactive power support could be more
321 beneficial. Moreover, as shown in Fig. 5, even though minimising voltage deviations is not
322 formulated as an objective function, the overall voltages increase with introduction of EV
323 reactive power flexibility since their capacitive behaviour locally supports the grid. Interest-
324 ingly, even though one would expect only capacitive EV behaviour, inductive behaviour is

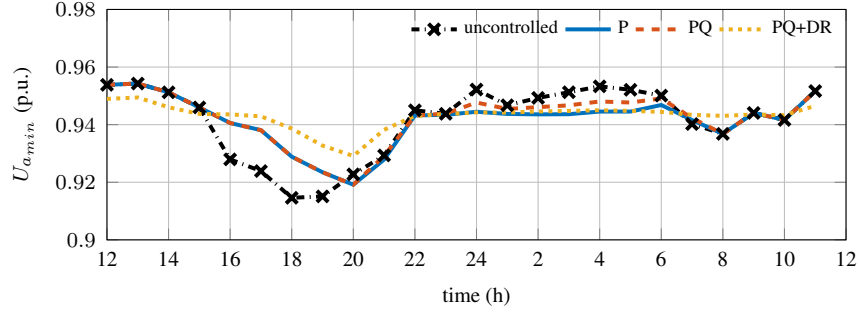

Fig. 5: Minimum phase a voltage values for Scenario I and the best compromise solutions of scenarios IIa to IIc ($\Gamma = 0$).

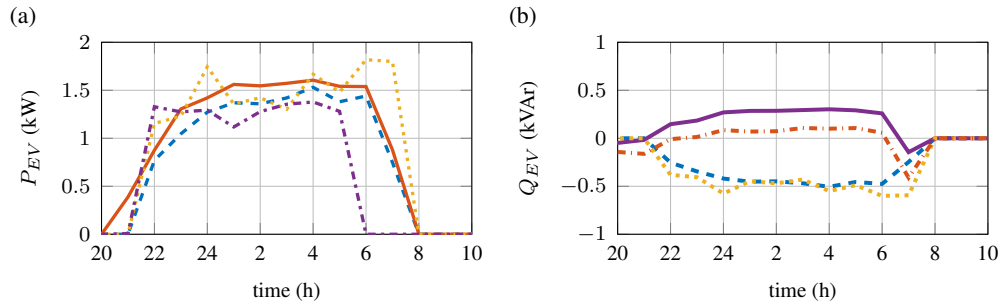

Fig. 6: (a) Active power, and (b) reactive power profiles for selected EVs in scenario IIc.

325 observed for some vehicles connected in area A as depicted in Fig. 6b. The reason behind are
 326 high unbalances in area A due to which several EVs behave inductively to bring the voltages
 327 closer together and consequently reduce overall unbalances which influence the losses.

328 Sensitivity analysis has been conducted for several parameters in Scenario IIc as shown in
 329 Fig. 7. First of all, the impact of EV charging efficiency is analysed by changing the value
 330 from 80% to 95% in 5% steps. As expected, EV charging efficiency has an impact both on the
 331 EV charging cost and the DSO losses. The higher is the efficiency, the greater are the benefits
 332 for both entities. Secondly, the impact of maximum EV charging rate has been analysed for
 333 three specific rates, i.e. 16 A, 32 A and 63 A, which equal to 3.7 kW, 7.4 kW and 14.5 kW
 334 under the nominal voltage. It can be observed that the EV charging power has an influence
 335 only on the maximum losses, whereas the maximum EV cost remains the same since the
 336 minimum losses are obtained for a more spread-out EV schedules which are not impacted
 337 by the maximum charging rate. However, the higher is the charging rate, the larger are the

338 losses in the best compromise solution since the DSO will be willing to pay more compared
 339 to the alternative. Finally, the impact of DR is analysed by changing the demand flexibility
 340 parameter from 0% to 15% in 5% steps. It is seen that demand response flexibility has a
 341 positive impact on the losses, but could potentially increase the maximum EV aggregator's
 342 cost. Nevertheless, for a fixed EV cost, losses are reduced as more demand flexibility is
 introduced.

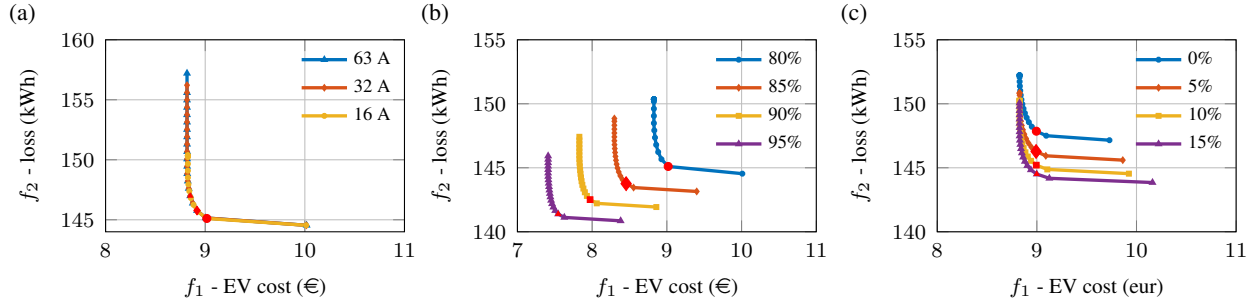

Fig. 7: Impact of (a) maximum EV charging rate, (b) EV charging efficiency, and (c) demand flexibility on Pareto optimal front in Scenario IIc (PQ+DR, $\Gamma = 0$).

343

344 3. *Scenario III*: In Scenario III, the algorithm tries to find a robust solution which minimises
 345 the total EV cost for different conservativeness degree Γ . The numerical values of possible
 346 EV costs for the best-compromise solution under different degrees of uncertainty are given in
 347 Table 1, whereas Fig. 8 depicts the impact of uncertainty level Γ on the Pareto front.

348 From Table 1, it is clear that the total EV cost is reduced when optimal scheduling is intro-
 349 duced compared to the base Scenario I, but as the uncertainty degree increases, possible EV
 350 cost increases as well. The more conservative the decision maker is, the further away will
 351 the robust solution be from the nominal case. Regardless, even in the worst case scenario
 352 with the most conservative degree ($\Gamma = 24$), the total cost is less than half compared to the
 353 base Scenario I. Above a certain degree Γ , the robust solution stays the same since EVs are
 354 scheduled only for several hours in the day, so uncertain prices in the remaining hours will
 355 not influence the final EV schedule and cost. One should also note how with the increase
 356 of the conservativeness degree, the value of EV flexibility, i.e., the difference between the
 357 robust case and the base case, also increases. Comparing Scenarios IIIa and IIIb, it is clear

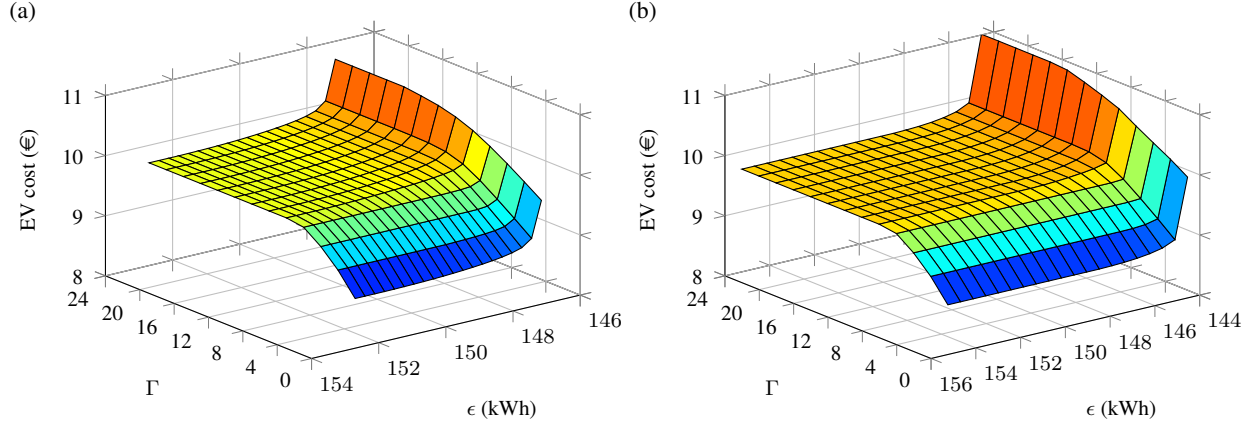

Fig. 8: Γ versus ϵ ($f_1 \leq \epsilon$) versus total EV cost in (a) Scenario IIIa and (b) Scenario IIIb.

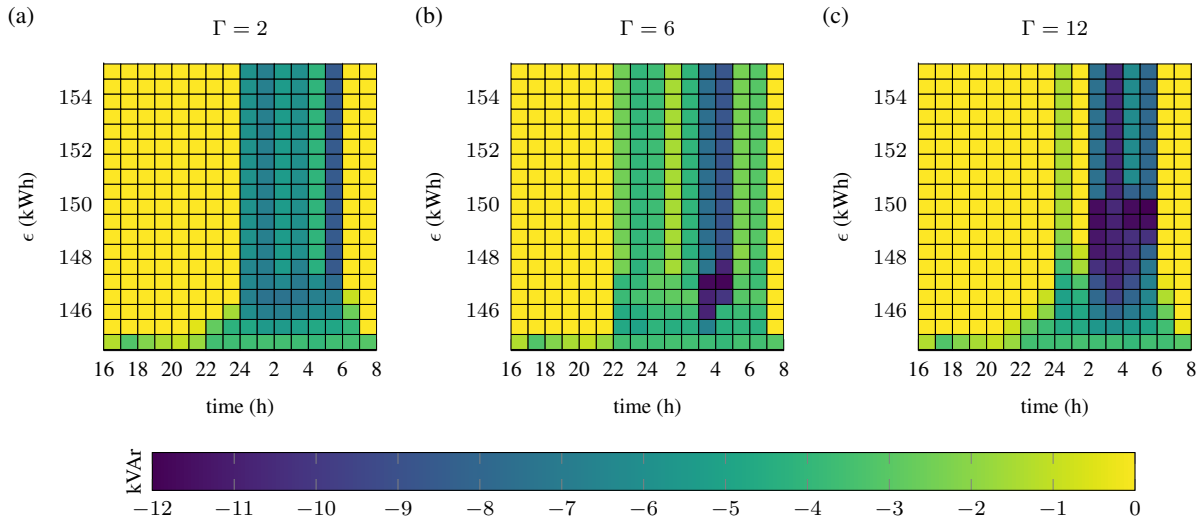

Fig. 9: Total EV reactive power $\sum Q_i^{EV}$ versus ϵ ($f_1 \leq \epsilon$) in Scenario IIIb for (a) $\Gamma = 2$, (b) $\Gamma = 6$, and (c) $\Gamma = 12$.

358 that minimum losses are lower in Scenario IIIb due to the additional demand response flexi-
 359 bility. Hence, similar to the nominal case, maximum EV cost increases and best-compromise
 360 solutions are somewhat higher than in Scenario IIIa, which can also be seen from values in
 361 Table 1.

362 The importance of utilising EV reactive power capability can also be appreciated from Fig. 9
 363 which depicts the cumulative EV reactive power profile in dependence of losses for three
 364 values of the conservativeness degree Γ . It can be observed that reactive power profiles differ
 365 since the flexibility is used to satisfy DSO's requirements with respect to losses differently.

366 In such way, modulating EV active power can potentially be avoided and, consequently, so
 367 can the increase in EV charging cost for various loss values.

368 In order to check the robustness of the proposed algorithm, a Monte Carlo simulation has
 369 been conducted. First, the robust EV schedule is obtained for Scenario IIIb with a set conser-
 370 vativeness degree $\Gamma = 12$ and $f_1 = \epsilon_{max}$ for which the total EV cost equals to 9.70 € (also
 371 seen from Table 1). Next, 10000 samples of price values $\lambda_{t_1 \rightarrow 24}$ are generated so that (25b)
 372 and (25c) are satisfied. The total EV cost based on the previously obtained decision variables
 373 is calculated for each price profile. Fig. 10 clearly shows that all obtained EV cost values are
 374 below the value specified by the robust optimisation model marked with a red line (9.70 €).
 375 This proves that applying the obtained decision variables ensures the aggregator that the total
 376 EV cost will not exceed the obtained robust solution as long as the total price uncertainties
 remain less than the conservativeness degree Γ .

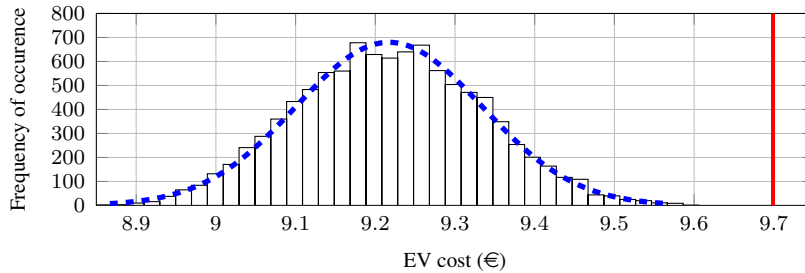

377 Fig. 10: Results of the Monte Carlo simulation for robustness check in scenario IIIb ($\Gamma = 12$,
 $f_1 = \epsilon_{max}$).

378 5. Conclusion

379 This paper presents a robust multi-objective model for optimal active and reactive EV scheduling
 380 in unbalanced distribution networks. Two objective functions have been used in resource schedul-
 381 ing, namely minimisation of losses which represents the DSO's concern, and minimisation of EV
 382 charging cost which represents the EV aggregator's main concern. After obtaining a Pareto front,
 383 a fuzzy set approach is used to select the best compromise solution, i.e., to minimise the maximum
 384 dissatisfaction of both parties. In addition, the impact of EV reactive power capability is investi-

385 gated, both on the objective functions' values and on the grid technical constraints.

386 The method was tested on a real Danish distribution network with a 35% EV penetration rate. The

387 multi-objective approach was able to obtain the Pareto front with a range of possible solutions,

388 whereas the fuzzy set approach gives a good compromise between the both considered objectives.

389 The robust problem formulation guarantees that the obtained EV cost is optimal as long as the total

390 price uncertainties are lower than the EV aggregator's conservativeness degree. Due to grid unbal-

391 ances, individual EV schedules differ depending on their connection point and available demand

392 response as well as the set conservativeness degree. It was observed that EV reactive power sup-

393 port can provide benefits for the DSO while not significantly affecting the EV aggregator's cost.

394 By introducing such a capability in grid codes, EVs would be able to provide local grid support

395 resulting in overall improved voltages, decreased losses and less need for reactive power from the

396 external grid.

397 The question remains what would be the cost of implementing EV reactive power control for volt-

398 age support since, without the existence of a voltage market or direct remuneration for voltage

399 regulation, it is difficult to assess the value of such service. The comparison with traditional DSO

400 means, e.g., implementation of capacitor banks, is highly dependent on the analysed grid making

401 it difficult to generalize the economic value, which remains an interesting topic for future work.

402 Additionally, the authors would like to incorporate other sources of uncertainty in the presented

403 model, i.e., demand and PV generation forecast errors and EV user behaviour uncertainty [42], as

404 well as to extend it with EV control in discrete current steps according to contemporary standard

405 IEC 61851 with harmonic analysis. Moreover, future work includes extending the model with

406 application to network planning purposes [43] and to real-time operation [44].

407 **Acknowledgment**

408 This work is supported by the Danish research projects "NIKOLA - Intelligent Electric Vehicle

409 Integration" under ForskEL kontrakt nr. 2013-1-12088, and "Parker" under ForskEL kontrakt nr.

410 2016-1-12410.

6. References

- [1] P. Siano, “Demand response and smart grids—a survey,” *Renewable and Sustainable Energy Reviews*, vol. 30, pp. 461 – 478, Feb 2014.
- [2] T. Shun, L. Kunyu, X. Xiangning, W. Jianfeng, Y. Yang, and Z. Jian, “Charging demand for electric vehicle based on stochastic analysis of trip chain,” *IET Generation, Transmission Distribution*, vol. 10, no. 11, pp. 2689–2698, 2016.
- [3] J. Hu, H. Morais, T. Sousa, and M. Lind, “Electric vehicle fleet management in smart grids: A review of services, optimization and control aspects,” *Renewable and Sustainable Energy Reviews*, vol. 56, pp. 1207 – 1226, Apr 2016.
- [4] W. Kempton and J. Tomić, “Vehicle-to-grid power implementation: From stabilizing the grid to supporting large-scale renewable energy,” *Journal of Power Sources*, vol. 144, pp. 280–294, Jun 2005.
- [5] K. Knezović, M. Marinelli, P. Codani, and Y. Perez, “Distribution grid services and flexibility provision by electric vehicles: A review of options,” in *Power Engineering Conference (UPEC), 2015 50th International Universities*, Sept 2015.
- [6] M. A. Ortega-Vazquez, F. Bouffard, and V. Silva, “Electric vehicle aggregator/system operator coordination for charging scheduling and services procurement,” *IEEE Transactions on Power Systems*, vol. 28, no. 2, pp. 1806–1815, May 2013.
- [7] Y. Tang, J. Zhong, and M. Bollen, “Aggregated optimal charging and vehicle-to-grid control for electric vehicles under large electric vehicle population,” *IET Generation, Transmission Distribution*, vol. 10, no. 8, pp. 2012–2018, 2016.
- [8] J. de Hoog, T. Alpcan, M. Brazil, D. A. Thomas, and I. Mareels, “Optimal charging of electric vehicles taking distribution network constraints into account,” *IEEE Transactions on Power Systems*, vol. 30, no. 1, pp. 365–375, Jan 2015.

- 435 [9] J. Franco, M. Rider, and R. Romero, “A mixed-integer linear programming model for the
436 electric vehicle charging coordination problem in unbalanced electrical distribution systems,”
437 *IEEE Transactions on Smart Grid*, vol. 6, no. 5, pp. 2200–2210, Sept 2015.
- 438 [10] G. Carpinelli, F. Mottola, and D. Proto, “Optimal scheduling of a microgrid with demand
439 response resources,” *IET Generation, Transmission Distribution*, vol. 8, no. 12, pp. 1891–
440 1899, 2014.
- 441 [11] A. Zecchino, J. Hu, M. Coppo, and M. Marinelli, “Experimental testing and model validation
442 of a decoupled-phase on-load tap-changer transformer in an active network,” *IET Generation,
443 Transmission Distribution*, vol. 10, no. 15, pp. 3834–3843, 2016.
- 444 [12] N. Leemput, F. Geth, J. V. Roy, J. Büscher, and J. Driesen, “Reactive power support in res-
445 idential LV distribution grids through electric vehicle charging,” *Sustainable Energy, Grids
446 and Networks*, vol. 3, pp. 24 – 35, Sept 2015.
- 447 [13] K. Knezović and M. Marinelli, “Phase-wise enhanced voltage support from electric vehicles
448 in a danish low-voltage distribution grid,” *Electric Power Systems Research*, vol. 140, pp. 274
449 – 283, 2016.
- 450 [14] H. Liang, B. J. Choi, W. Zhuang, and X. Shen, “Stability Enhancement of Decentralized
451 Inverter Control Through Wireless Communications in Microgrids,” *IEEE Transactions on
452 Smart Grid*, vol. 4, no. 1, pp. 321–331, March 2013.
- 453 [15] Smart Energy Demand Coalition, “Mapping Demand Response in Europe Today,” 2015.
- 454 [16] M. N. Mojdehi, M. Fardad, and P. Ghosh, “Technical and economical evaluation of reactive
455 power service from aggregated EVs,” *Electric Power Systems Research*, vol. 133, pp. 132 –
456 141, Apr 2016.
- 457 [17] K. M. Tan, V. K. Ramachandaramurthy, and J. Y. Yong, “Optimal vehicle to grid planning
458 and scheduling using double layer multi-objective algorithm,” *Energy*, vol. 112, pp. 1060 –
459 1073, 2016.

- 460 [18] M. Manbachi, A. Sadu, H. Farhangi, A. Monti, A. Palizban, F. Ponci, and S. Arzanpour,
461 “Impact of EV penetration on volt–var optimization of distribution networks using real-time
462 co-simulation monitoring platform,” *Applied Energy*, vol. 169, pp. 28 – 39, 2016.
- 463 [19] X. Bai and W. Qiao, “Robust optimization for bidirectional dispatch coordination of large-
464 scale V2G,” *IEEE Transactions on Smart Grid*, vol. 6, no. 4, pp. 1944–1954, July 2015.
- 465 [20] H. Gao, J. Liu, and L. Wang, “Robust coordinated optimization of active and reactive power
466 in active distribution systems,” *IEEE Transactions on Smart Grid*, vol. PP, no. 99, pp. 1–1,
467 2017.
- 468 [21] B. Jiang and Y. Fei, “Decentralized scheduling of pev on-street parking and charging for smart
469 grid reactive power compensation,” in *2013 IEEE PES Innovative Smart Grid Technologies
470 Conference (ISGT)*, Feb 2013, pp. 1–6.
- 471 [22] T. Sousa, H. Morais, Z. Vale, and R. Castro, “A multi-objective optimization of the active and
472 reactive resource scheduling at a distribution level in a smart grid context,” *Energy*, vol. 85,
473 pp. 236 – 250, Jun 2015.
- 474 [23] J. García-Villalobos, I. Zamora, K. Knezović, and M. Marinelli, “Multi-objective optimiza-
475 tion control of plug-in electric vehicles in low voltage distribution networks,” *Applied Energy*,
476 vol. 180, pp. 155 – 168, 2016.
- 477 [24] B. Ansari, M. G. Simoes, A. Soroudi, and A. Keane, “Restoration strategy in a self-healing
478 distribution network with dg and flexible loads,” in *2016 IEEE 16th International Conference
479 on Environment and Electrical Engineering (EEEIC)*, June 2016, pp. 1–5.
- 480 [25] M. M. A. Abdelaziz, H. E. Farag, E. F. El-Saadany, and Y. A. R. I. Mohamed, “A novel and
481 generalized three-phase power flow algorithm for islanded microgrids using a newton trust
482 region method,” *IEEE Transactions on Power Systems*, vol. 28, no. 1, pp. 190–201, Feb 2013.
- 483 [26] E. Sortomme, A. I. Negash, S. S. Venkata, and D. S. Kirschen, “Voltage dependent load
484 models of charging electric vehicles,” *2013 IEEE Power Energy Society General Meeting*,
485 pp. 1–5, Jul 2013.

- 486 [27] K. Knezovic, S. Martinenas, P. B. Andersen, A. Zecchino, and M. Marinelli, “Enhancing the
487 role of electric vehicles in the power grid: Field validation of multiple ancillary services,”
488 *IEEE Transactions on Transportation Electrification*, vol. 3, no. 1, pp. 201–209, Apr 2017.
- 489 [28] A. Soroudi, M. Ehsan, R. Caire, and N. Hadjsaid, “Hybrid immune-genetic algorithm method
490 for benefit maximisation of distribution network operators and distributed generation owners
491 in a deregulated environment,” *IET Generation, Transmission Distribution*, vol. 5, no. 9, pp.
492 961–972, September 2011.
- 493 [29] K. Deb, *Multi-objective optimization using evolutionary algorithms*. John Wiley & Sons,
494 2001, vol. 16.
- 495 [30] A. Soroudi and T. Amraee, “Decision making under uncertainty in energy systems: state of
496 the art,” *Renewable and Sustainable Energy Reviews*, vol. 28, pp. 376–384, 2013.
- 497 [31] A. J. Conejo, J. Contreras, R. Espínola, and M. A. Plazas, “Forecasting electricity prices for a
498 day-ahead pool-based electric energy market,” *International Journal of Forecasting*, vol. 21,
499 no. 3, pp. 435 – 462, 2005.
- 500 [32] D. Bertsimas and M. Sim, “The price of robustness,” *Operations research*, vol. 52, no. 1, pp.
501 35–53, 2004.
- 502 [33] A. Soroudi, P. Siano, and A. Keane, “Optimal DR and ESS scheduling for distribution losses
503 payments minimization under electricity price uncertainty,” *IEEE Transactions on Smart
504 Grid*, vol. 7, no. 1, pp. 261–272, Jan 2016.
- 505 [34] K. Paridari, A. Parisio, H. Sandberg, and K. H. Johansson, “Robust Scheduling of Smart
506 Appliances in Active Apartments With User Behavior Uncertainty,” *IEEE Transactions on
507 Automation Science and Engineering*, vol. 13, no. 1, pp. 247–259, Jan 2016.
- 508 [35] M. Basu, “An interactive fuzzy satisfying method based on evolutionary programming tech-
509 nique for multiobjective short-term hydrothermal scheduling,” *Electric Power Systems Re-
510 search*, vol. 69, no. 2, pp. 277–285, 2004.

- 511 [36] K. Strunz, N. Hatzigiorgiou, and C. Andrieu, “Benchmark systems for network integration of
512 renewable and distributed energy resources,” *Cigre Task Force C*, vol. 6, pp. 04–02, 2009.
- 513 [37] IEC 61851-1:2010, “Electric vehicle conductive charging system – Part 1: General require-
514 ments,” 2010.
- 515 [38] A. Kiildsen, A. Thingvad, S. Martinenas, and T. M. Sørensen, “Efficiency test method for
516 electric vehicle chargers,” in *International Battery, Hybrid and Fuel Cell Electric Vehicle
517 Symposium (EVS29)*, Jun 2016.
- 518 [39] N. H. Tehrani and P. Wang, “Probabilistic estimation of plug-in electric vehicles charging
519 load profile,” *Electric Power Systems Research*, vol. 124, pp. 133 – 143, 2015.
- 520 [40] P. Andersen, “Intelligent electric vehicle integration - domain interfaces and supporting in-
521 formatics,” Ph.D. dissertation, Technical University of Denmark, 2013.
- 522 [41] A. M. Geoffrion, “Generalized benders decomposition,” *Journal of Optimization Theory and
523 Applications*, vol. 10, no. 4, pp. 237–260, 1972.
- 524 [42] Y. Cao, T. Wang, O. Kaiwartya, G. Min, N. Ahmad, and A. H. Abdullah, “An EV Charging
525 Management System Concerning Drivers’ Trip Duration and Mobility Uncertainty,” *IEEE
526 Transactions on Systems, Man, and Cybernetics: Systems*, vol. PP, no. 99, pp. 1–12, 2016.
- 527 [43] P. Maghouli, A. Soroudi, and A. Keane, “Robust computational framework for mid-term
528 techno-economical assessment of energy storage,” *IET Generation, Transmission Distribu-
529 tion*, vol. 10, no. 3, pp. 822–831, 2016.
- 530 [44] S. Nojavan, B. Mohammadi-Ivatloo, and K. Zare, “Optimal bidding strategy of electricity re-
531 tailers using robust optimisation approach considering time-of-use rate demand response pro-
532 grams under market price uncertainties,” *IET Generation, Transmission Distribution*, vol. 9,
533 no. 4, pp. 328–338, 2015.