



Title	Scenario modelling: A holistic environmental and energy management method for building operation optimisation
Authors(s)	O'Donnell, James, Keane, Marcus, Bazjanac, Vladimir, et al.
Publication date	2013-07
Publication information	O'Donnell, James, Marcus Keane, Vladimir Bazjanac, and et al. "Scenario Modelling: A Holistic Environmental and Energy Management Method for Building Operation Optimisation." Elsevier, July 2013. https://doi.org/10.1016/j.enbuild.2012.10.060 .
Publisher	Elsevier
Item record/more information	http://hdl.handle.net/10197/4777
Publisher's statement	This is the author's version of a work that was accepted for publication in Energy and Buildings. Changes resulting from the publishing process, such as peer review, editing, corrections, structural formatting, and other quality control mechanisms may not be reflected in this document. Changes may have been made to this work since it was submitted for publication. A definitive version was subsequently published in Energy and Buildings (62 (2013)) DOI: http://dx.doi.org/10.1016/j.enbuild.2012.10.060
Publisher's version (DOI)	10.1016/j.enbuild.2012.10.060

Downloaded 2026-05-02 01:17:47

The UCD community has made this article openly available. Please share how this access benefits you. Your story matters! (@ucd_oa)



© Some rights reserved. For more information

Scenario Modelling: A Holistic Environmental and Energy Management Method for Building Managers

Corresponding Author:

James O'Donnell – JTODonnell@lbl.gov – Phone: +1-510-486-4146
Building Technologies Group; Lawrence Berkeley National Laboratory
1 Cyclotron Road, MS 90R3111
Berkeley, CA 94720

Authors:

Marcus Keane – marcus.keane@nuigalway.ie
Informatics Research Unit for Sustainable Engineering
National University of Ireland
Galway, Ireland

Vladimir Bazjanac – v_bazjanac@lbl.gov
Building Technologies Group; Lawrence Berkeley National Laboratory
1 Cyclotron Road, MS 90R3111
Berkeley, CA 94720

Elmer Morrissey – edmorrissey@lbl.gov
Building Technologies Group; Lawrence Berkeley National Laboratory
1 Cyclotron Road, MS 90R3111
Berkeley, CA 94720

Abstract

Building managers have specific duties and certain outputs that are required of them. Without the necessary data, information, tools, and time, they are unable to adequately meet their organisational goals. Scenario modelling enables explicit and unambiguous coupling of building functions with other pivotal aspects of building operation in a method that specifically considers the education and technical expertise of building managers. This new method captures, transforms, and communicates the complex interdependencies of environmental and energy management in buildings through an easily navigable, holistic, and reproducible checking mechanism that compares actual performance with predicted performance and completes the “plan-do-check-act” cycle for building managers. Most important, the structured nature of this method caters to the diverse profile of building managers, making it applicable for widespread deployment. This paper demonstrates the benefit of using the new method by examining its application to a performance analysis of two existing buildings.

Keywords: Energy management method, holistic building performance appraisal, performance metrics

1 Introduction

Many factors contribute to the inefficient operation of buildings. These include poor construction methods, inadequate design, the absence of comprehensive testing, inconsistent and at times poor quality of measured data, and inefficient operations practices [1]. Unavailable, unreliable, and inaccurate performance information is a major cause for inefficient building operation. Information used by building managers must be trustworthy, but there are no standards currently available for analysing and transforming building performance data and information. In addition, current methods and tools fail to account for the profile of building managers, both in terms of the operational context of their role and their typical technical and educational background [2]. As a result, the information communicated to building managers can result in decisions that are often ad-hoc, arbitrary, and incomplete [3].

In practice, analysis methods applied to building operations vary in complexity. Performance benchmarks usually originate from prescriptive code compliance, energy performance guidelines established externally, results from whole-building energy simulation models, and from rules of thumb or conventional wisdom [4]. Such benchmarks are typically difficult to disaggregate, as they fail to contain enough meta-data for a comparison with systems and components in a given building. For example, building managers might compare a building's annual gross energy consumption with data about its previous years' performances or with normalised data from similar buildings, but they may not have the resources to break down energy end use by type. Normative comparison methods include Chartered Institution of Building Services Engineers (CIBSE) Guide F, ENERGY STAR, and Dutch NEN 2916 [5–7] and the more advanced U.S. General Services Administration (GSA) Building Performance Toolkit that offers objective performance indicators communicable between different project stakeholders [8]. However, these methods fail when they involve building-to-building comparison when all the compared buildings operate inefficiently and when the methods do not comprehensively take into account each building's unique nature. In the cases where a calibrated whole-building energy simulation model exists, measured performance is extremely difficult to compare with predicted performance [9–11]. To complicate matters further, measured HVAC time-series data describe building performance in higher resolution but wholly depend upon weather and control strategies [12].

Structured methods applied by experts have resulted in energy conservation measures that have saved an average of over 20% of total energy costs and over 30% of heating and cooling costs in more than 100 studied U.S. buildings [13]. Such experts brought in to “fix” building systems provide one possible solution to identifying causes of inefficient operation in the building stock [14,15]. This requires recognition that experts with the appropriate knowledge and skills are needed including adequate resources and time. Therefore, an expert reliant solution to inefficient operation of buildings is impractical when dealing with the global building stock.

Standards are another proven approach in the areas of quality control system and environmental management system [16,17]. International Standards Organization (ISO) 50001 has been in effect since mid 2011, but it is only practical for organisations with significant energy consumption; i.e., industrial facilities, as opposed to commercial buildings. ISO 50001 requires organisations to commit resources and employ adequately trained personnel. The key difference between the ISO standards and typical building management of commercial buildings is that the ISO standards use Deming's cycle—also known as the Plan-Do-Check-Act (PDCA) cycle—and that this cycle provides a communication mechanism between building operators and upper management, thus incorporating important stakeholders in energy management activities [18].

ISO 50001 is an auditable checklist of auditable responsibilities for completion by trained actors within the organisation [19]. Conversely, commercial buildings lack a standardised operating process, and building managers have a diverse range of backgrounds, knowledge, training, and education. A profiling exercise carried out in Ireland revealed that building managers typically come from other positions within industry and rarely

have the skills and training specifically required for optimum building management [2].¹ Due to the noted shortage of experts, responsibility for optimum building operation should fall on building managers, but such a solution must rely upon an accurate profile of this role that also includes inputs, operating process, and outputs.

The role of a building manager can be frustrating and stressful [20]. Limited organisational resources typically restrict building managers to a “plan-do” method of operation that does not include checking and validation, or reporting to upper management. In this role (Figure 1), building managers must manage the inputs on which they base their analysis and decisions. Tools such as Building Management Systems (BMS) that control HVAC systems or Energy Information Systems (EIS) that display energy consumption may be at hand, but the absence of underlying data and formal data transformation to support effective decision making is a key weakness for building managers. These tools provide data in a context-independent manner, where building function, system operation, and energy performance are not explicitly related. Therefore, analysis activities carried out within the context of a “plan-do” process, but in the absence of adequate checking, can result in questionable outputs that are not reviewed by upper management. From an organizational perspective, any outputs based on questionable or missing data may invalidate the actions of a building manager. With regard to outputs expected from a building manager, he or she must manage system performance and associated energy consumption, educate building occupants about building function, report on environmental impact, communicate with financial controllers and represent owners with respect to capital purchases and utility tariffs (Figure 1). In practice, the workload associated with the role normally exceeds available resources, and the building manager has very little time to focus on building performance analysis [2].

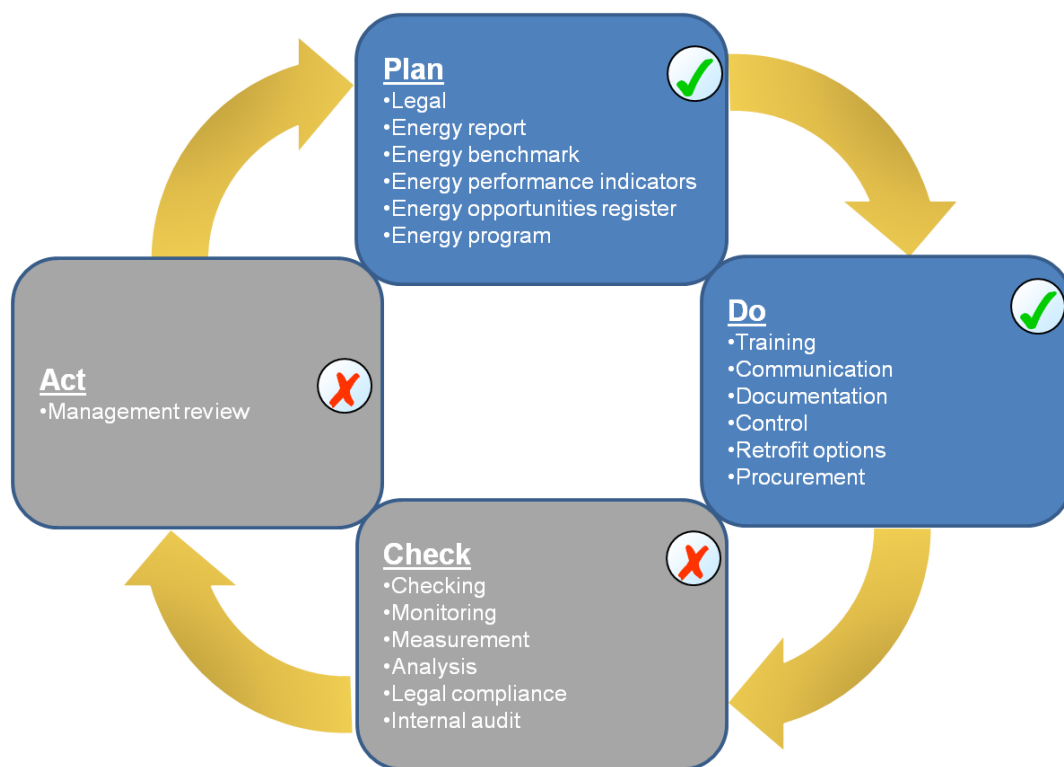

Figure 1: Commercial building managers apply a “plan-do” cycle due to a typical shortage of organisational resources. An integrated checking process would complete the PDCA cycle and enable continuous improvement in building performance.

¹ The authors consider that Ireland is at the forefront of skill-set development for building managers [21,22] and that Irish building managers are representative of global building managers.

Building operation requires understanding a building's function with respect to different aspects of performance that in turn require access to data and information that describe a building's performance over time. A building manager must quickly process the data into meaningful information, understand this information and, when necessary, make decisions in real time. Building performance evaluation should be non-subjective and based on reproducible methods [23]. However, present-day processes are typically subjective, require manual data manipulation, and are therefore time consuming, as databases generated by adequately instrumented buildings are enormous. Furthermore, a typical building manager does not have the time necessary for such an extensive process. New methods must include a structure that allows automated rule-based data transformations coupled with standardised presentation formats, so that building managers can effectively use both real-time and archived information, especially if data are presented at the necessary resolution and frequency. Ideally, a building manager requires a structured, standardised process that uses the appropriate tools.

A solution to inefficient building operation must account for the varying education and skill sets of analysts and building managers. In addition, the solution must recognise organizational objectives with respect to building function, energy efficiency, and legislation. Where possible, the solution must automate tasks, specifically with regard to transforming data into information that can be used for decision making.

This paper presents the *scenario-modelling* method to address current gaps in building performance analysis as performed by building managers. The scenario-modelling method recognises the education and skills of global building managers as well as their organisational role. Scenario modelling specifically captures and communicates the complex interdependencies of organizational requirements, in terms of building function, system performance, energy efficiency and legislation (Section 2). It relies upon systematic and structured transformations of raw data as typically available from a range of data acquisition systems into information that adequately and explicitly supports effective decision making (Section 3). In Section 4, the applicability of scenario modelling is demonstrated in two buildings, each of which has unique user requirements.

2 Holistic Performance Analysis

Holistic building performance analysis must account for the multi-faceted nature of building operation. Thermophysical conditions and energy flows resulting from a complex matrix of heat transfers and energy balances are difficult, if not impossible, to convey through conventional BMS and EIS tools. In practice, typical BMS tools fail to recognise the educational and technical profile of building managers. To further compound the issue, those tools do not address the organisational objectives that in many cases do not regard environmental conditions and energy issues as a priority. This paper aims to address two key issues for building managers:

1. How to identify and collect all data that relate/respond to holistic building performance while filtering what is irrelevant in the sea of measured data.
2. How to present relevant data so that a manager with limited technical skills can understand the building's behaviour.

To comprehensively address these key issues, this paper considers building performance from the perspective of the building manager. It proposes that holistic building performance assessment requires five categories (herein called *performance aspects* and defined as *building function*, *thermal loads*, *systems performance*, *energy consumption*, and *legislation*) that are appropriate for a building manager, and places a particular emphasis on the interrelationships between performance aspects (Figure 2). This section focuses on important variables and concepts within each performance aspect in the context of holistic building performance. It begins with an overview of *building function*, which is the most important performance aspect from an organisational perspective.

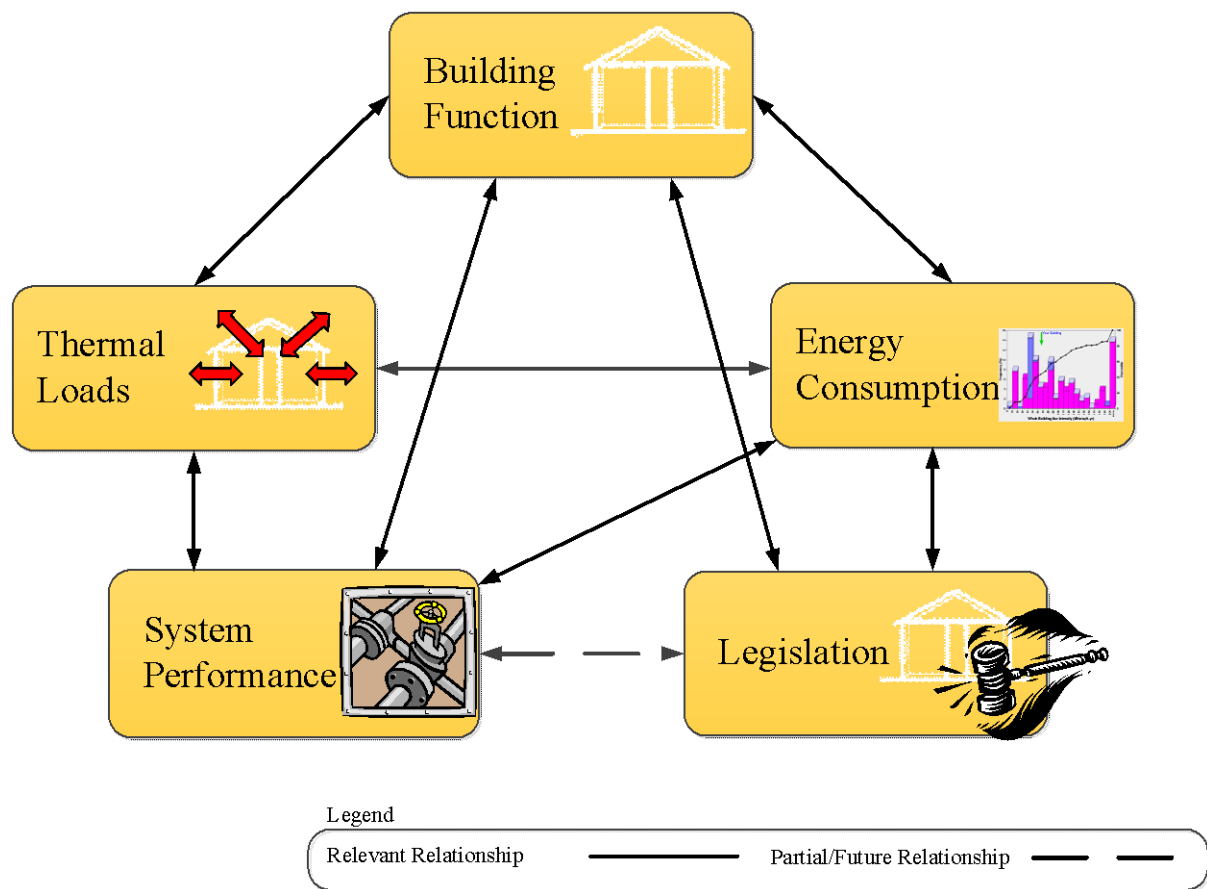

Figure 2: Holistic building performance analysis as evaluated by building managers relies on an understanding of five key performance aspects and the interdependencies between these performance aspects.

Building function, defined as a controlled environment for a given purpose, is of paramount importance for most organisations and is therefore a priority for building managers. In office environments, comfortable working conditions, quantifiable in terms of dry-bulb temperature, relative humidity, airflow rates, and other measures, dramatically influence occupant productivity [24–26]. Other pivotal variables affect lighting and thermal comfort; these include average window luminance, maximum window luminance, background luminance, and transmitted vertical solar radiation at the window [27]. Conventional BMS can record all of these variables individually but do not link building function to the other important building performance aspects.

Building function or desired indoor environmental conditions significantly affect thermal loads (Figure 2). Internal equipment and lighting normally create a sensible load that may or may not vary during occupied hours. Occupants, however, create sensible and latent loads that vary with their activity level. Furthermore, external weather dependant loads vary with outside air temperature, solar gains, building orientation, time of day, cloud cover, seasonal factors, etc. Conventional systems typically meet building function and respond to changes in zone loads, but information on why such a change occurred is rarely available to building managers. In addition, conventional analysis typically represents environmental factors in terms of outside air temperature. Only experts using their skills and experience can link alterations in thermal loads to the resultant change in system performance. However, building managers need access to reliable quantitative descriptions of all thermal loads over time.

Systems such as HVAC and others must satisfy building function while accounting for associated thermal loads (Figure 2), especially in cases requiring precise control. A building manager must have the tools and quantitative measures to evaluate the performance of all systems, especially in non-conventional cases. This

work advocates a systems approach to problem detection that identifies compounding problems, such as when a conditioned zone is unintentionally exposed to the exterior environment by manually opening a window. In this case, the zone consumes unnecessary energy, as does the heating coil and boiler. A building manager requires notification of these unnecessary energy consumptions and, most important, the magnitude of all wasteful consumptions. For naturally ventilated zones, measurements of magnitudes of aperture openings are critical. A building manager requires data for naturally ventilated zones that allow comparison of system operating status, system performance, and building function [28,29]. Other systems also contribute to building function, such as the Integrated Building Environmental Control System (IBECS) sensor network technology, which can relay required localised occupancy, lighting levels, and luminance values to a building manager via a control system [30]. Occupancy detection systems that use carbon dioxide (CO₂) measurements or infrared sensing to determine the presence of occupants outperform schedule-based control strategies [31], [32], but building managers require measurements at the micro-zone (occupant-specific) level [33]. At all levels of analysis, a building manager must have the ability to compare actual systems performance and associated energy consumption with a reliable equivalent prediction. Output from whole-building energy simulation models can provide these predicted data, but building managers require a mechanism with which to leverage these vast data.

Optimum operation therefore minimises energy consumption while satisfying building function (Figure 2). With relevant data, at the required levels of resolution and presented in an appropriate format, a building manager could optimise operation while accounting for systems performance, thermal loads, building function, and energy performance. However, building managers must have the ability to disaggregate consumption into what is relevant to building function and what is unnecessary waste, especially when utility providers use dynamic pricing strategies [34].

Commercial building function, systems performance, energy consumption, and CO₂ emissions are presently unregulated by legislation (Figure 2). As of this writing, only certain operational aspects must comply with legislation. The European Performance of Buildings Directive [35] requires an energy label for certain categories of buildings. Other optional European legislation named the Emissions Trading Scheme, as defined by European Union (EU) Directive 2003/87/EC [36], applies to portfolios of buildings, campuses, or individual buildings. It is probable that future legislation will regulate CO₂ emissions against a defined threshold. To optimise actions regarding future legislative compliance, building managers need data, processing methods, and display tools to compare actual, historical, and predicted CO₂ emissions with a legally defined threshold [37].

In summary, building managers require a systematic method that is capable of holistically relating the complex interrelationships between building function, thermal loads, systems, energy consumption, and legislation. Section 3 introduces the scenario-modelling method as the solution to this present weakness.

3 Scenario-Modelling Method

The scenario-modelling method captures and communicates holistic building performance information for the established profile of building managers. Scenario modelling is a life-cycle method that leverages raw or unprocessed data at all phases of the Building Life Cycle (BLC). During design and construction, only energy simulation model outputs are available, but during commissioning and operation, measured data from sensor and meters complement energy simulation model outputs. During the design phase, a dedicated and appropriately qualified professional should define scenario models that represent the building's predicted performance. Energy simulation modellers are the ideal professionals for creating scenario models and for updating these models over the BLC, as they are responsible for quantifying building performance expectations.

The simulation specialist, acting as part of a design team, can define a number of key scenario models after forming an expert opinion on how the building should optimally operate. These scenario models could focus on the function of important zones, major energy consumers, critical systems, and any combination of these. A practical approach, based on the conventional wisdom of current practitioners, could result in scenario models

that account for approximately 80% of energy consumption in a building and, where relevant, include other performance aspects. This strategy would avoid sub-metering smaller loads and all energy consumption that falls outside of this 80% threshold; i.e., the remaining 20% would require a separate scenario. As the scenario-modelling technique leverages both simulated and measured data, a simulation specialist, during design, could check the effectiveness of their scenario model set using output from whole-building energy simulation models and pass the scenario model set to a building manager who then has access to output from whole-building energy simulation models and measured data to operate the building.

During day-to-day operation, a building manager can use scenario models to check that the building operates optimally. Building function typically varies over time, thus requiring updates to a building’s set of scenario models. The simulation specialist can work with the building manager to define these changes. In effect, this cycle introduces a continuously updated optimum performance benchmark for use by building managers and thus brings the PDCA cycle to commercial building management.

The following text details the concept and hierarchical structure of scenario models (Figure 3) and concludes with an example. Scenario models fundamentally transform raw data that are difficult for building managers to process (such as BMS data or energy simulation model output data) into a form that is easily understandable and on which decisions can be based; thus enabling building managers to compare actual performance against expected design intent. Such reproducible transformations leverage formulae to generate specific grades of information, and in doing so, remove subjective data manipulation and minimise subjective interpretation. Additionally, automated data transformations have the potential to enhance productivity and deliver significant organisational benefit.

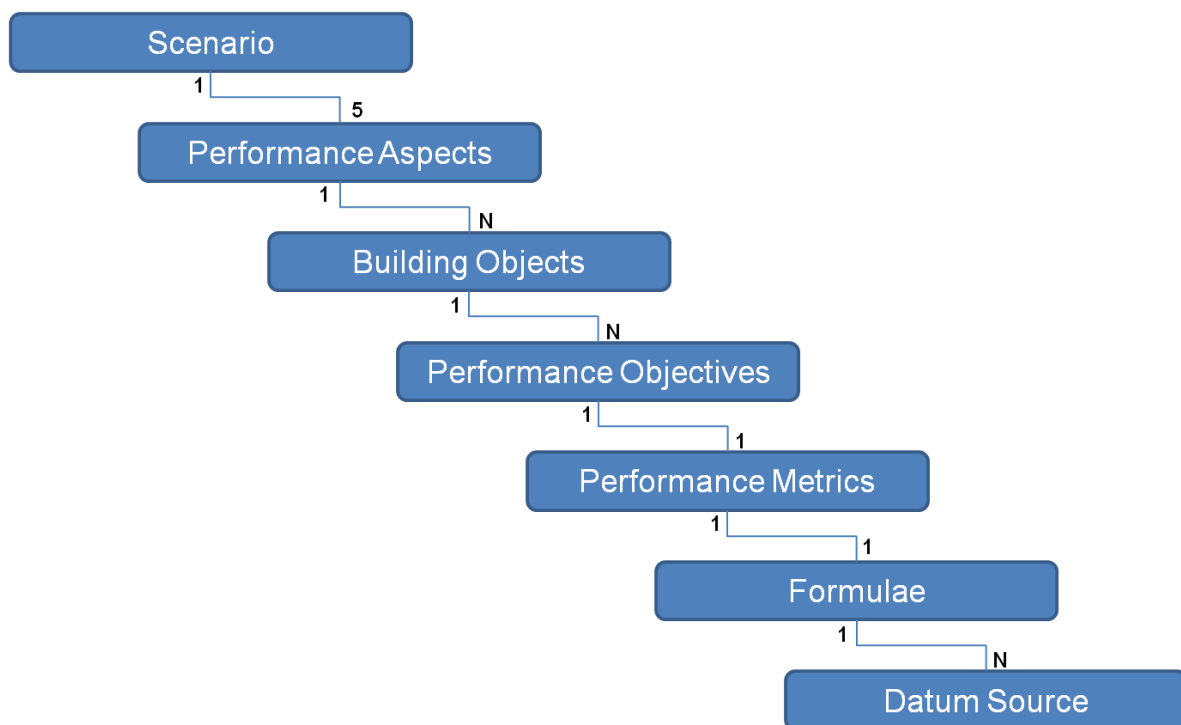

Figure 3: Class diagram representation of the scenario-modelling method. Objectified relationships store content while only exposing relevant data to building managers, and thus enable holistic, yet flexible, performance analysis.

Two automated and reproducible data transformations underpin scenario models (Figure 3). The first transformation processes specific raw data streams into standardised quantitative descriptions, called *performance metrics*, according to a predefined mathematical formula. Each metric definition contains only one formula that may access raw data from any number (denoted as N) of predefined data streams. For example, the performance metric “zone temperature” uses data from only one data stream, but the performance metric “zone

thermal comfort” uses data from numerous data streams that include zone temperature, zone humidity ratio, air velocity, and occupant clothing level. Most important, this generic formula is independent of datum source, so where relevant, it will process measured data from a building, predicted data generated by a whole building simulation model, and utility provider data such as dynamic tariffs in an identical manner [34]. This generic approach enables identical processing of data from different sources and facilitates a one-to-one comparison between measured and predicted data. Time series plots or summary tables are the most common representations for large sets of quantitative data. In addition, trend analysis and anomaly detection techniques identify areas of inefficient operation. However, given the profile of building managers and the time constraints associated with the role, stand-alone performance metrics may not suffice. Therefore, a non-subjective yet reliable mechanism is required.

The second transformation evaluates a single performance metric against a single predefined condition and returns a result to the building manager. Such rule-based conditions evaluate 1) measured performance metrics, 2) simulated performance metrics or (most important) 3) measured performance metrics against simulated performance metrics, thus checking actual performance against predicted performance. The most effective communication mechanism for this type of check is a traffic light convention using red for a critical warning, orange for a less severe warning, and green for operating within defined parameters [37]. For example, display a red light if a defined performance metric “zone temperature” exceeds an allowable deadband during occupied hours. The result is a qualitative performance description called *standardised performance objectives* [38], a terminology that is more suitable to building managers (Figure 3), and enables building managers to make decisions almost instantaneously. A performance objective may simply return a Boolean value if a quantitative performance metric exceeded a boundary condition over a given time period.

All performance objectives and metrics require a context. Current building managers are familiar with performance analysis contexts that include *building* energy use intensity, *air-system* supply temperature, and *chiller* Coefficient of Performance (COP). The scenario-modelling method recognises conventional performance analysis contexts and categorises them as building objects (see Figure 3). The full category list includes building portfolio, building site, building, building story or tenant, zone, micro-zone (required for optimum HVAC and lighting control), HVAC systems, and HVAC system components. The applied object-based convention maintains consistency by associating performance categories such as “utility consumption” and “energy end-use breakdown” with the building. An individual building object may have any number of performance objectives.

A second contextual layer could also improve the efficacy of building managers. Performance aspects defined in Section 2, coupled with building objects, enable holistic performance evaluation in a manner customised for building managers. It is important to note that each of the five performance aspects can reference any number of building objects, and that the same building object can be referenced by up to five performance aspects (Figure 3). Furthermore, an individual scenario model may contain up to five performance aspects. The overall scenario-modelling structure enables a detailed holistic view of building performance while offering flexibility in terms of breadth and depth of individual scenarios.

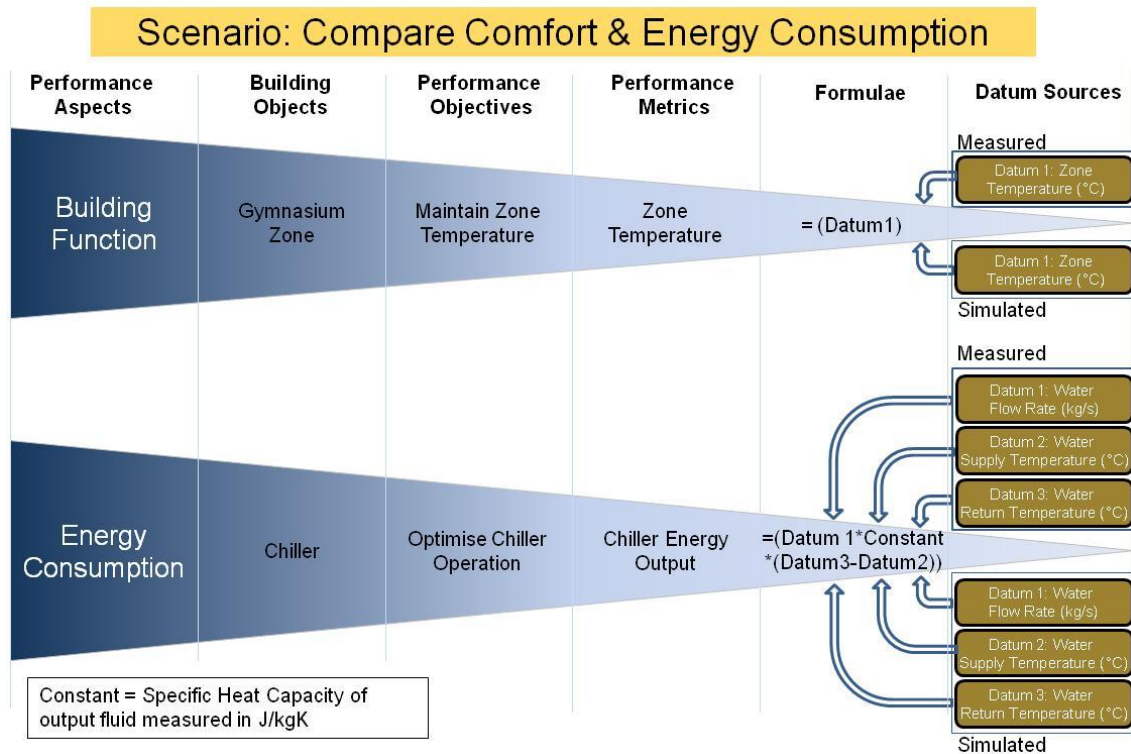

Figure 4: A scenario model highlighting sample content and the relationships between performance aspects, performance objectives and metrics, algorithms, and measurement streams.

A succinct yet sufficiently detailed example illustrates how the scenario-modelling structure represents data for use by a building manager (Figure 4). The hypothetical example compares energy consumption of a chiller against a change in zone temperature under the building function and energy consumption performance aspects.

From the perspective of the building manager, the sample scenario highlights two of the major changes that occur because of the “change in zone temperature setpoint” under both the *building function* and *energy consumption* performance aspects. The measured and predicted zone-temperature performance metrics illustrate a dry bulb temperature discrepancy. The measured and predicted chiller output performance metrics highlight the resultant change in chilled water output. This chilled water output metric, measured in kilowatts (kW), uses a formal transformation process defined in [2] and uses three data streams for input (Equation 1). The algorithm, defined in Equation 1 uses mass flow rate of fluid \dot{m} in kilograms per second (kg/s), specific heat capacity C_p in Joules per kilogram Kelvin (J/kgK), flow temperature of fluid T_f in °K and return temperature of fluid T_r in °K [39].

$$\text{Chilled Water Output} = \dot{m} \times C_p \times (T_f - T_r) \quad [1]$$

The measured performance metric would then use the measured mass flow rate of water and the measured flow and return temperatures. Similarly, the equivalent predicted performance metric uses the simulated mass flow rate of water and the simulated flow and return temperatures. The generically defined formulae enable benchmarking between predicted or previous performance through a one-to-one comparison of performance metrics. Systematically structured data formats facilitate automated post processing of data and remove the need for manual data manipulation by building managers. This approach is particularly important for building managers who wish to make decisions in real time, now that functionality to support real-time simulation outputs is available [40]. Data format guidelines with respect to frequency, resolution, and accuracy also ensure consistency of performance data across all phases of the BLC [41].

Based on the holistic information presented, a building manager can visualise an unnecessary increase in chiller energy consumption, identify the cause of this increase and, if necessary, readjust the zone temperature set point.

4 Scenario-Model Demonstration

We now demonstrate the scenario-modelling method's versatility and effectiveness by applying it to two example buildings with different purposes and functional spaces. The two buildings are the Mardyke Sports Arena (Demonstration 1) and the Environmental Research Institute (ERI) (Demonstration 2), both at University College Cork (UCC), Ireland. Researchers had unrestrained access to their respective BMS, but each BMS had a limited set of data points. Demonstration 1 relies on an overview of the limited measured data, while Demonstration 2 uses available BMS data. For both demonstrations, detailed, up-to-date energy simulation models were not available for either building. Each demonstration description follows the same structure:

- Characteristics or limitations of the scenario;
- Description of pre-event conditions;
- Scenario description and downstream effects of the event;
- Scenario schematic.

Each scenario includes the pre-event steady-state building condition, the event itself, a transitional period following the event, and the downstream effects of the event on the post-event equilibrium. Each scenario focuses on particular building performance characteristics (indoor environmental conditions, zone temperature conditions, and heating or cooling systems) and communicates holistic performance information through performance aspects for the profiled building manager.

4.1 Demonstration 1: Mardyke Arena

The Mardyke Sports Arena at UCC is a 6,500 square meter (m²) sports centre. It consists of a swimming pool, a sports hall, fitness suites, offices, meeting rooms, performance laboratories, dance studios, and catering facilities. This demonstration focuses on the gymnasium zone, which contains fitness machines and a weight lifting area. The scenario event is a manual temperature setpoint reduction from 19°C to 17°C, which is typical for this zone type. The dedicated full fresh air system consists of a supply fan, a heating coil, a cooling coil, and a return fan (**Error! Reference source not found.**). Heat recovery is not available. The characteristics of the Mardyke test scenario are:

- Gymnasium zone;
- Summer cooling conditions;
- Constant outdoor temperature;
- A variable volume air system;
- Constant relative humidity setpoint;
- Equal occupancy before and after setpoint change;
- Sensible and latent heat values for occupants at different temperatures [42];
- Cooling coil diverter valve (variable volume mass flow).

This scenario describes pre-event zone conditions of 19°C and 50% relative humidity (**Error! Reference source not found.**). The internal thermal gains remain constant throughout.

The scenario-modelling methodology rapidly conveys the following important information to the building manager through the performance aspects shown in Figure 6.

1. *Building Function*: There has been a change in zone temperature (measured in °C).
2. *Thermal Loads*: The change in zone temperature setpoint increases the sensible occupant gains and decreases the latent occupant gains (Measured in kW).
3. *Systems Performance*: The change in thermal loads increases the cooling coil load and chiller load (Measured in kW).
4. *Energy Consumption*: The increase in chiller load increases cooling-related electrical consumption, and therefore increases building electrical consumption (Measured in kilowatt-hours [kWh] over time).

5. *Legislation:* Increased energy consumption deviates from design intent, and if continued over time will increase the building's annual CO₂ emissions (measured in tons), which is undesirable under impending EU legislation.

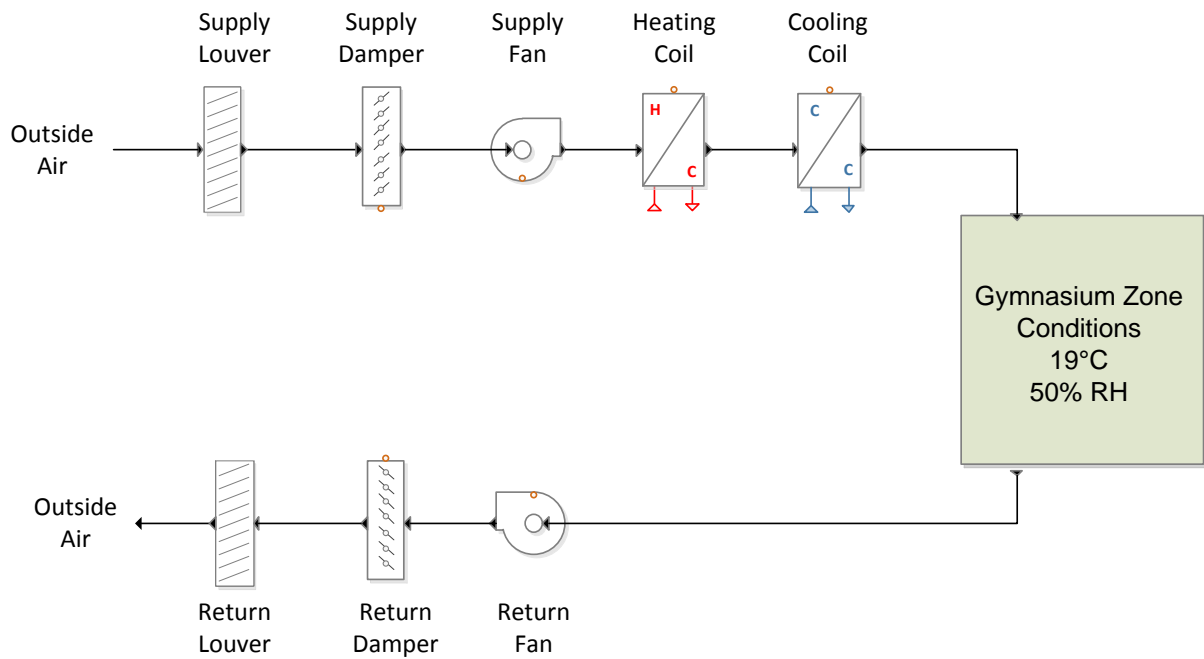

Figure 5: Simplified representation of full fresh air system at the Mardyke Sports Arena, UCC, illustrating the dedicated heating and cooling system for the gymnasium zone.

Scenario: Reduction of Gymnasium Zone Temperature

Performance Aspects	Building Objects	Performance Objectives	Performance Metrics	Formulae	Datum Sources
Building Function	Gymnasium Zone	Maintain Zone Temperature	Zone Temperature	=(Datum1)	Measured Datum 1: Zone Temperature (°C)
					Simulated Datum 1: Zone Temperature (°C)
System Performance	AHU-1	Maintain Intended Supply Temperature	Supply Temperature	=(Datum1)	Measured Datum 1: Zone Temperature (°C)
					Simulated Datum 1: Zone Temperature (°C)
Energy Consumption	Chiller-1	Minimise Chiller Energy Consumption	Chiller Electricity Consumption	=(Datum 1)	Measured Datum 1: Electrical Meter (kW)
					Simulated Datum 1: Electrical Meter (kW)
Energy Consumption	Cooling Tower -1	Minimise Cooling Tower Loads	Cooling Tower Electricity Consumption	=(Datum 1)	Measured Datum 1: Electrical Meter (kW)
					Simulated Datum 1: Electrical Meter (kW)
Energy Consumption	AHU-1	Minimise Fans Energy Consumption	AHU Electricity Consumption	=(Sum Component Electricity Meters)	Measured Required Electricity Meters
					Simulated Required Electricity Meters
Legislation	Building	Maintain CO ₂ emissions below agreed level	CO ₂ emissions	=(Sum Utility Type CO ₂ emissions)	Measured Required Datum Streams
					Simulated Required Datum Streams

Figure 6: Detailed information for demonstration scenario model 1. This model highlights the changes in building function, systems performance, energy consumption, and legislation after a manual setpoint change.

If further analysis is necessary, the standardised and structured nature of the scenario ensures that the underlying data and formulae are readily available for each performance metric. Figure 6 illustrates the breadth and depth of data and information that is necessary for a building manager to make an informed decision. He/she presently lacks a mechanism that can qualify and quantify the results of decisions and/or to support decision making. Without all of the information, the building manager may only speculate on the comfort, financial, and

environmental consequences of his actions. Such lack of concrete information can result in unforeseen additional operating costs and emissions.

4.2 Demonstration 2: Environmental Research Institute

The Environmental Research Institute (ERI), also located at UCC, was designed as a low-cost energy research facility. The building contains both laboratory and office spaces, which is prudent, as recent studies identified laboratory facilities as ideal targets for energy-saving practices throughout the BLC [43]. The ERI itself is an ongoing experiment in green building design and operation, with a particular research emphasis on downstream performance [44]. The building features passive solar architecture, improved insulation, improved thermal bridging, design for reduced infiltration levels, quality natural lighting and ventilation, and a state-of-the-art BMS that monitors the integrated hybrid heating/cooling system (Figure 7), the building energy use, and the building's indoor environmental conditions.

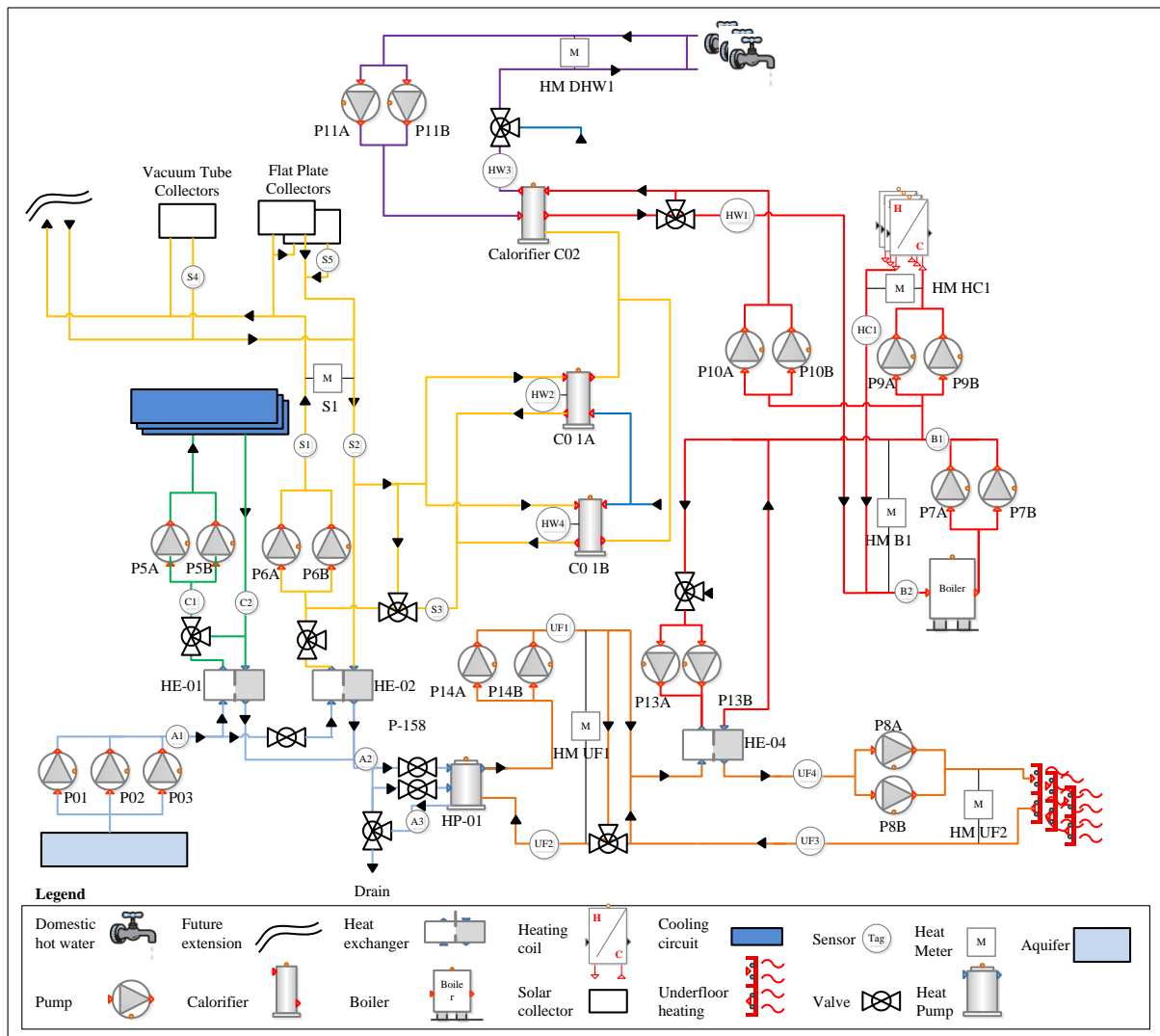

Figure 7: Diagram of the ERI integrated hybrid heating and cooling system. The complexity of this system makes it an appropriate choice for testing the scenario-modelling concept.

The ERI test scenario is an overall evaluation of the heating system (as depicted in Figure 7) and has the following characteristics:

- Two zones with unique functions and orientations;
- Spring season but heating conditions;
- Outdoor temperature that varies over the analysis time period;

- Naturally ventilated zones coupled with under-floor heating;
- Uncontrolled relative humidity.

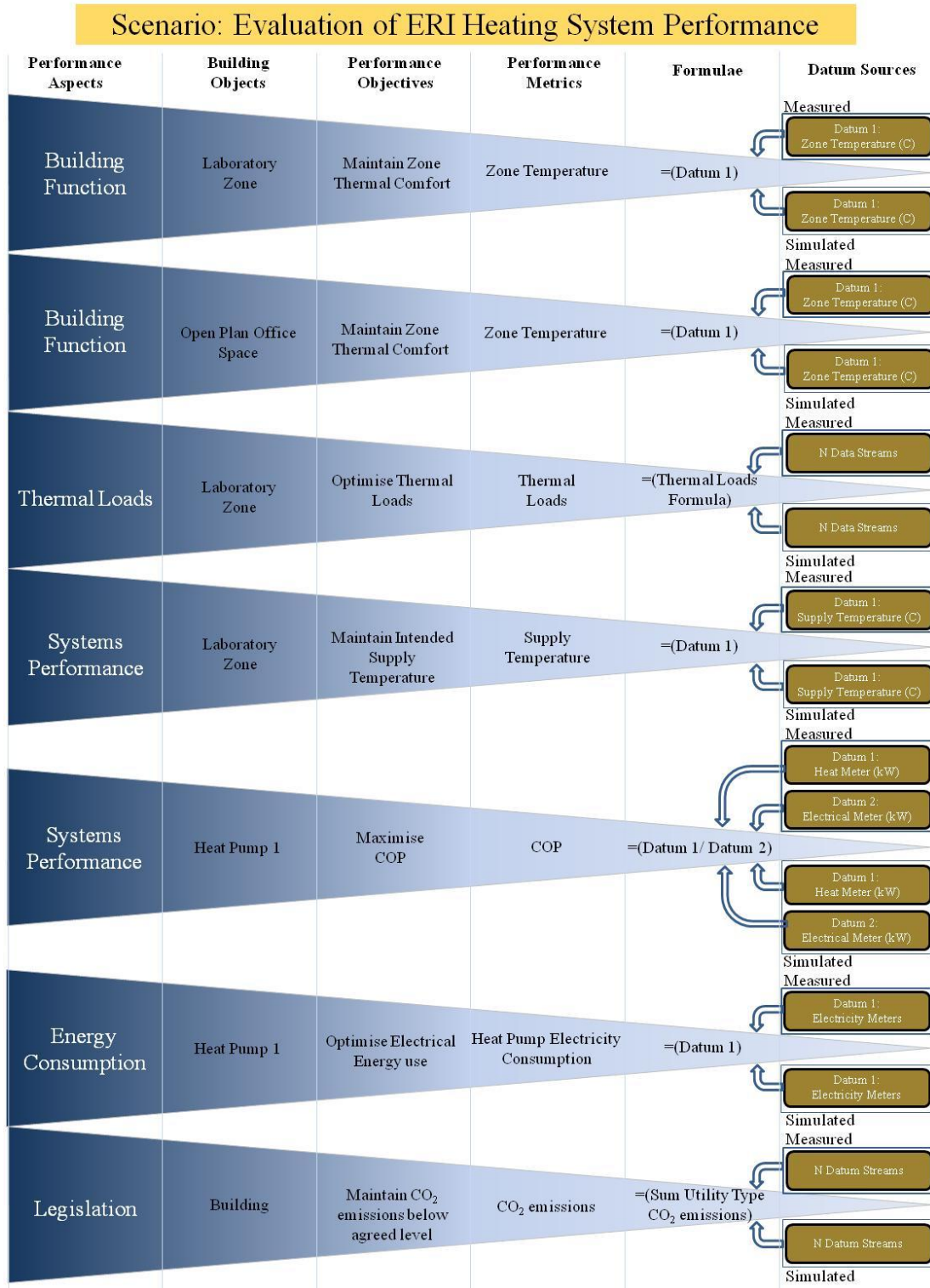

Figure 8: Detailed information for demonstration scenario model 2. This model illustrates the data and information needed to identify an inefficiently operating heat pump without a change in zone conditions.

This scenario describes an evaluation of performance of the low-energy heating system in the context of thermal comfort in the occupied zones. The scenario-modelling methodology rapidly conveys the following important information and conveys it to the building manager through the performance aspects shown in Figure 8:

1. Building Function: Zone temperatures were within allowable parameters during occupied hours of the analysis time period (Figure 9). Zones using thermal mass and natural ventilation do not need to be precisely controlled. The range of zone temperatures is within design intent.

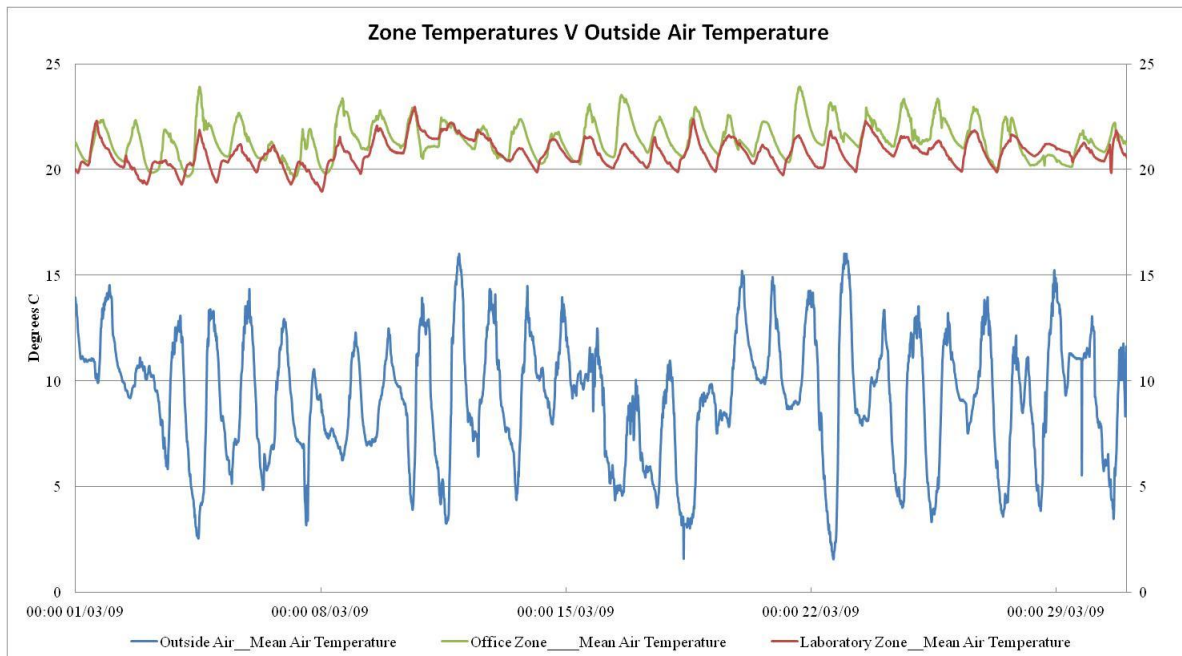

Figure 9: Time series plot illustrating how building function, as represented by zone temperature, remains within the intended boundaries during the analysis period.

2. Thermal Loads: No change in internal thermal loads, but loads due to exterior conditions have not adversely affected zone temperatures (measured in kW).
3. Systems Performance: The supply temperature to the zones (measured in °C) has not changed, but there has been a dramatic change in COP of the heat pump (Figure 10). Such a change is unexpected, as an open source aquifer supplies the inlet of the evaporator on the heat pump at a relatively constant temperature. In this case, the design intent COP was 4.2, and the measured average for this time period was 3.14.

COP of ERI Heat Pump for March 2009

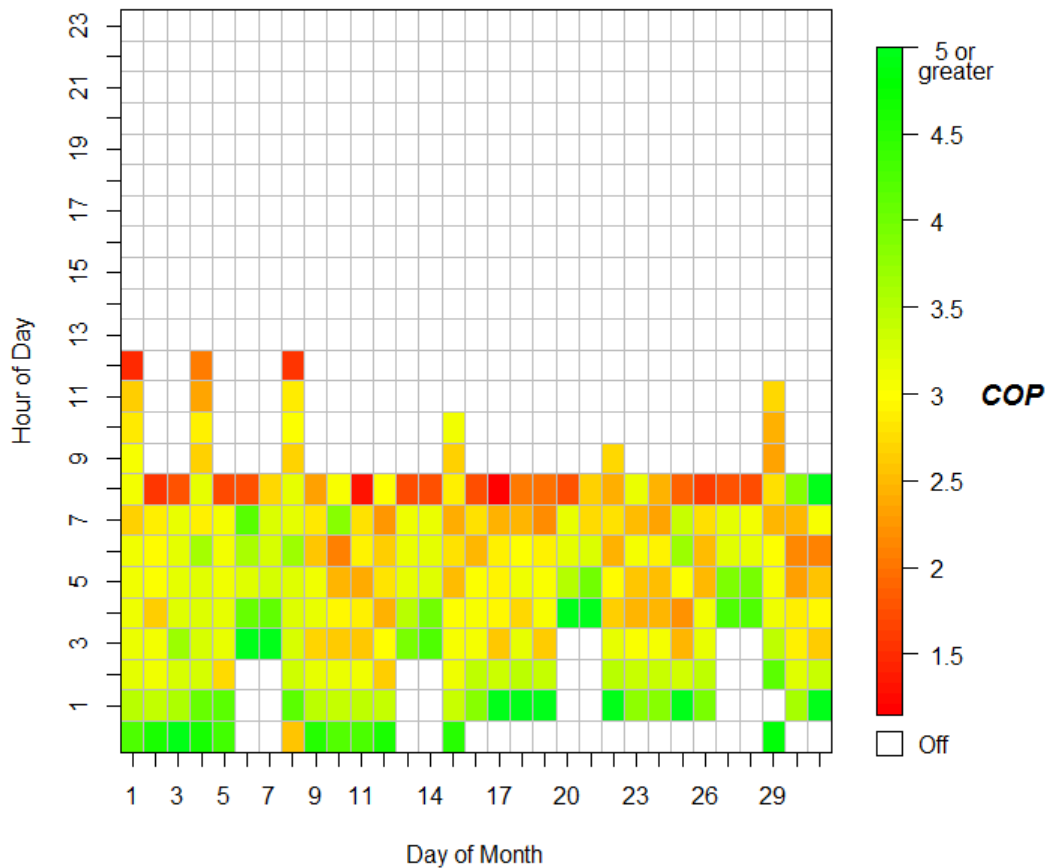

Figure 10: ERI heat pump performance as quantified by COP for March 2009.

4. Energy Consumption: The intended operational strategy of the heat pump uses a cheaper electricity tariff by operating at night and stores heat in the thermal mass of the building. The reduction in COP of the heat pump causes a dramatic increase in heat pump electricity consumption (measured in kWh over time).
5. Legislation: Increased energy consumption deviates from design intent, and if continued over time will increase the building's annual CO₂ emissions, which is undesirable under impending EU legislation (measured in tons of CO₂).

The scenario description focuses on the building's primary heating source. This experiment identified that the heat pump was manually adjusted as opposed to controlled by the BMS, and therefore fails to operate in accordance with design intent. This scenario shows that the *building function*, *thermal loads*, and *system performance* remain unaffected (Figure 8). However, the *energy consumption* performance aspect indicates significant changes in the electricity consumption and cost of operation (Figure 8). If unchecked, this deviation from design intent would have increased the building's annual CO₂ emissions. This could result in unforeseen additional operating costs and emissions, which would be undesirable under impending EU legislation.

5 Conclusions and Future Work

Building managers have specific duties and certain outputs that are required of them. Without the necessary data, information, tools, and time, they are unable to adequately meet their organisational goals. Scenario modelling enables explicit and unambiguous coupling of building function with other pivotal aspects of building

operation in a method that specifically considers the education and technical expertise of building managers. The method addresses key weaknesses of current methods, tools and technologies by:

- Defining the data required for holistic performance analysis activities;
- Defining reproducible transformations of data into information that is interpretable by profiled building managers;
- Providing a check mechanism for one-to-one comparison of predicted performance (as provided by whole building energy simulation models, guidelines, or prescriptive codes) and measured performance (as recorded by sensors and meters);
- Communicating this holistic information in a context specifically designed for the established profile of building managers;
- Optimizing the time spent by building managers on performance analysis, and in turn optimizing building performance;
- Removing the need for subjective or expert intervention with respect to holistic performance analysis.

Most important, the scenario-modelling method enables an application of Deming's plan-do-check-act cycle in the performance analysis of commercial buildings. With this method, building managers have reliable information which they can communicate to other stakeholders at the tactical and strategic levels of organisations [45], and thus enable more informed energy-related decisions by upper management, who require a return on investment for any new method or technology. Scenario-modelling can provide maximum organisational benefit if defined during design and updated across the BLC. For existing buildings such as the two demonstrators, scenario models, from a cost-saving perspective, can rely on available measured data.

Future work in this area should include a software environment to create and edit scenario models that reads and writes data from a specifically defined Model View Definition (MVD) [46] of an Industry Foundation Classes (IFC)-based Building Information Models (BIM) [47]. An interoperable IFC-based approach would integrate scenario modelling with the design/build/commission/operate process and create a focal point for integrated, multi-stakeholder decision making over the life cycle of a project; particularly during design and operation. In doing so, scenario modelling could optimise building performance at each stage of the building life cycle and therefore deliver optimally operating buildings.

6 Acknowledgements

The authors would like to thank Marie Casley for her objective review and also Nataša Mrazović and Youness Bennani Smires for assistance with images.

The financial support of Enterprise Ireland through funding for the BuildWise project is gratefully acknowledged.

This work was supported by the Assistant Secretary for Energy Efficiency and Renewable Energy, Office of Building Technology, Building Technologies Program of the U.S. Department of Energy under Contract No. DE-AC02-05CH11231.

7 References

- [1] M. A. Piette, S. K. Kinney, P. Haves, Analysis of an information monitoring and diagnostic system to improve building operations, *Energy and Buildings* 33 (8) (2001) 783-791.
- [2] J. O'Donnell, Specification of Optimum Holistic Building Environmental and Energy Performance Information to Support Informed Decision Making, Ph.D Thesis, <http://zuse.ucc.ie/iruse/publications.html>, University College Cork, 2009.

- [3] C. Neumann and D. Jacob, Results of the project Building EQ. Tools and methods for linking EPBD and continuous commissioning, Fraunhofer ISE, EIE/06/038/SI2 .448300, 2010.
- [4] E. Morrissey, Building Effectiveness Communication Ratios (BECs): An Integrated 'Life-Cycle' Methodology for Mitigating Energy-use in Buildings, PhD Thesis, University College Cork, 2006.
- [5] CIBSE, CIBSE Guide F: Energy Efficiency in Buildings, CIBSE, 2004.
- [6] NEN, NEN 2916: Energy Performance of Non-residential Buildings Determination Method, Dutch Normalization Institute (NEN), Standardization Institute, Delft, 1999.
- [7] ENERGY STAR, Normalize Data, 2006. [Online]. Available: www.energystar.gov/index.cfm?c=assess_performance.normalize. [Accessed: 11-Feb-2011].
- [8] G. Augenbroe and C.-S. Park, Quantification Methods of Technical Building Performance, *Building Research & Information* 33 (2) (2005), 159-172.
- [9] A. Costa, M. Keane, P. Raftery, and J. O'Donnell, Key factors Methodology - A Novel Support to the Decision Making Process of the Building Energy Manager in Defining Optimal Operation Strategies, *Journal of Civil Engineering and Architecture*, Accepted.
- [10] P. Raftery, M. Keane, J. O'Donnell, Calibrating whole building energy models: An evidence-based methodology, *Energy and Buildings* 43 (9) (2011) 2356-2364.
- [11] P. Raftery, M. Keane, A. Costa, Calibrating whole building energy models: Detailed case study using hourly measured data, *Energy and Buildings*, Accepted.
- [12] P. Raftery, M. Keane, A. Costa, Calibrating whole building energy models: Detailed case study using hourly measured data, *Energy and Buildings* 43 (12) (2011) 3666-3679.
- [13] M. Liu, D. E. Claridge, W. D. Turner, Continuous CommissioningSM of Building Energy Systems, *Journal of Solar Energy Engineering* 125 (3) (2003) 275-281.
- [14] O. Baumann, Enhanced Building Operation Using 'Operation Diagnostics' - A Case Study, in: *International Conference for Enhanced Building Operations*, October 11-13, 2005 Pittsburgh, Pennsylvania, USA, 2005.
- [15] O. Baumann, Operation Diagnostics-Use of Operation Patterns to Verify and Optimize Building and System Operation, in: *International Conference for Enhanced Building Operations*, Paris, France, 2004.
- [16] ISO, ISO 9001:2008 - Quality management systems — Requirements. International Organization for Standardization, 2008.
- [17] ISO, ISO 14001:2004 - Environmental management systems — Requirements with guidance for use. International Organization for Standardization, 2004.
- [18] G. J. Langley, R. Moen, K. M. Nolan, T. W. Nolan, C. L. Norman, L. P. Provost, *The Improvement Guide: A Practical Approach to Enhancing Organizational Performance*, second ed., Jossey-Bass, 2009.
- [19] ISO, ISO 50001:2011 - Energy management systems — Requirements with guidance for use. International Organization for Standardization, 2011.
- [20] M. Ahern, Energy Management in UCC (Interview), 18-2006.
- [21] NSAI, IS 393, National Standards Authority of Ireland, 2005. [Online]. Available: www.nsai.ie/News_and_Events/Latest_News/I.S._393.html. [Accessed: 02-Nov-2011].
- [22] SEAI, SEAI - Energy MAP, 2005. [Online]. Available: <http://www.seai.ie/EnergyMAP/>. [Accessed: 05-Oct-2011].
- [23] V. Bazjanac et al., An Assessment of the use of Building Energy Performance Simulation in Early Design, in: *IBPSA Building Simulation 2011*. Sydney, Australia, 2011.
- [24] W. J. Fisk, D. Black, G. Brunner, Changing ventilation rates in U.S. offices: Implications for health, work performance, energy, and associated economics, *Building and Environment* 47 (no. 1), (2012) 368-372.
- [25] W. J. Fisk, D. Black, G. Brunner, Benefits and costs of improved IEQ in U.S. offices, *Indoor Air*, 21 (5) (2011) 357-367.
- [26] D. Clements-Croome, *Intelligent Buildings*. Thomas Telford. ISBN 0727732668, 2004.

- [27] V. Inkarojrit, *Balancing Comfort: Occupants Control of Window Blinds in Private Offices*, PhD Thesis, University of California, Berkeley, 2005.
- [28] T. Leephakpreeda, Adaptive Occupancy-based Lighting Control via Grey Prediction, *Building and Environment* 40 (7) (2005) 881-886.
- [29] V. Garg and N. K. Bansal, Smart occupancy sensors to reduce energy consumption, *Energy and Buildings* 32 (1) (2000) 81-87.
- [30] F. Rubinstein and P. Pettler, Development of the IBECS Environmental Sensor and the Circuit Demand Monitor, Lawrence Berkeley National Laboratory and Vistron LLC, Prepared for California Energy Commission Public Interest Energy Research Program HPCBS E3P2.1T3c & E3P2.1T4c, Oct. 2002.
- [31] M. Mysen, S. Berntsen, P. Nafstad, P. G. Schild, Occupancy density and benefits of demand-controlled ventilation in Norwegian primary schools, *Energy and Buildings* 37 (12) (2005) 1234-1240.
- [32] M. Mysen, J. P. Rydock, P. O. Tjelflaat, Demand controlled ventilation for office cubicles-can it be profitable?, *Energy and Buildings* 35 (7) (2003) 657-662.
- [33] V. L. V. Hartkopf, Global Relevance of Total Building Performance, *Automation in Construction* 8 (1999) 377-393.
- [34] M. A. Piette, O. Sezgen, D. S. Watson, N. Motegi, C. Shockman, L. ten Hope, Development and Evaluation of Fully Automated Demand Response in Large Facilities, California Energy Commission, CEC-500-2005-013, Jan. 2005.
- [35] EU, Energy Performance of Buildings Directive 2010/31/EU. 2010.
- [36] EU, Directive 2003/87/EC of the European Parliament and of the council of 13 October 2003 establishing a scheme for greenhouse gas emission allowance trading within the Community and amending Council Directive 96/61/EC, European Union, 2003.
- [37] J. O'Donnell, E. Morrissey, M. Keane, V. Bazjanac, B. O. Gallagoir, Reducing Building Operational Cost Through Environmental Effectiveness Ratios, in: *IBPSA Building Simulation 2005*. Montreal, Canada, 2005.
- [38] R. Hitchcock, 'Standardized Building Performance Metrics' LBNL Technical Report for CEC PIER High Performance Commercial Building Systems Program, LBNL Report No. 53072, 2003.
- [39] ASHRAE, 2009 ASHRAE Handbook Fundamentals. American Society of Heating, Refrigerating and Air-Conditioning Engineers, ISBN 978-1-933742-55-7, 2009.
- [40] X. Pang, P. Bhattacharya, Z. O'Neill, P. Haves, M. Wetter, T. Bailey, Real-Time building energy simulation using EnergyPlus and the Building Controls Virtual Test Bed, in: *IBPSA Building Simulation 2011*, Sydney, Australia, 2011.
- [41] K. L. Gillespie, P. Haves, R. J. Hitchcock, J. J. Deringer, K. Kinney, A Specifications Guide for Performance Monitoring Systems, Pacific Gas and Electric Company, 1, Mar. 2007.
- [42] W. P. Jones, *Air Conditioning Applications and Design*, Second. Butterworth Heinemann, 1997.
- [43] P. Wirdzek, W. Lintner, P. Mathew, N. Carlisle, Energy efficiency programs for niche markets: The Labs21 program as an exemplar, in 2004 ACEEE Summer Study on Energy Efficiency in Buildings, Pacific Grove, California, USA, 2004.
- [44] A. Pearson, States Tackle Emissions, *Building Services Journal* 09/05 (2005) 9.
- [45] D. Pati, C.-S. Park, G. Augenbroe, Roles of quantified expressions of building performance assessment in facility procurement and management, *Building and Environment* 44 (4) (2009) 773-784.
- [46] buildingSMART, IFC Solutions Factory, The Model View Definition Site, 07-Apr-2011. [Online]. Available: <http://www.blis-project.org/IAI-MVD/>. [Accessed: 08-Mar-2011].
- [47] buildingSMART, Industry Foundation Classes (IFC) Homepage, 2011. [Online]. Available: <http://buildingsmart.org/>. [Accessed: 12-Dec-2011].

