



Title	A Survey on Mobile Augmented Reality with 5G Mobile Edge Computing: Architectures, Applications and Technical Aspects
Authors(s)	Siriwardhana, Yushan, Porambage, Pawani, Liyanage, Madhusanka, Ylianttila, Mika
Publication date	2021-02-25
Publication information	Siriwardhana, Yushan, Pawani Porambage, Madhusanka Liyanage, and Mika Ylianttila. "A Survey on Mobile Augmented Reality with 5G Mobile Edge Computing: Architectures, Applications and Technical Aspects." IEEE, February 25, 2021. https://doi.org/10.1109/comst.2021.3061981 .
Publisher	IEEE
Item record/more information	http://hdl.handle.net/10197/12097
Publisher's statement	This work is licensed under a Creative Commons Attribution 4.0 License. For more information, see https://creativecommons.org/licenses/by/4.0/
Publisher's version (DOI)	10.1109/comst.2021.3061981

Downloaded 2026-05-02 01:17:27

The UCD community has made this article openly available. Please share how this access benefits you. Your story matters! (@ucd_oa)



© Some rights reserved. For more information

A Survey on Mobile Augmented Reality with 5G Mobile Edge Computing: Architectures, Applications and Technical Aspects

Yushan Siriwardhana, *Member, IEEE*, Pawani Porambage, *Member, IEEE*, Madhusanka Liyanage, *Senior Member, IEEE* and Mika Ylinatila, *Senior Member, IEEE*,

Abstract—The Augmented Reality (AR) technology enhances the human perception of the world by combining the real environment with the virtual space. With the explosive growth of powerful, less expensive mobile devices, and the emergence of sophisticated communication infrastructure, Mobile Augmented Reality (MAR) applications are gaining increased popularity. MAR allows users to run AR applications on mobile devices with greater mobility and at a lower cost. The emerging 5G communication technologies act as critical enablers for future MAR applications to achieve ultra-low latency and extremely high data rates while Multi-access Edge Computing (MEC) brings enhanced computational power closer to the users to complement MAR. This paper extensively discusses the landscape of MAR through the past and its future prospects with respect to the 5G systems and complementary technology MEC. The paper especially provides an informative analysis of the network formation of current and future MAR systems in terms of cloud, edge, localized, and hybrid architectural options. The paper discusses key application areas for MAR and their future with the advent of 5G technologies. The paper also discusses the requirements and limitations of MAR technical aspects such as communication, mobility management, energy management, service offloading and migration, security, and privacy and analyzes the role of 5G technologies.

Index Terms—5G, Multi-Access Edge Computing (MEC), Cloud, Mobile Augmented Reality (MAR), Augmented Reality (AR), Network Architecture

I. INTRODUCTION

AUGMENTED Reality (AR) technology provides an enhanced perception of the real-world objects, by including additional information over the user’s actual view. In general, an AR system projects computer-generated augmentations on top of real objects, combining real and virtual objects to function synchronously [1]. The combination enables real and virtual objects to act with synchronicity and provide a proper depth of perception for the user. Besides providing visual augmentations, specific AR devices support voice inputs, audio outputs and haptic feedback to make the applications more sophisticated and informative. Thus, AR provides users with additional information on their surrounding environment by analysing the environment, deriving essential details from the scene, and augmenting it with additional knowledge provided

Yushan Siriwardhana, Pawani Porambage and Mika Ylinatila are with the Centre for Wireless Communications, University of Oulu, email: first-name.lastname@oulu.fi

Madhusanka Liyanage is with the School of Computer Science, University Collage Dublin, Ireland and Centre for Wireless Communications, University of Oulu, Finland, email: madhusanka@ucd.ie

from databases [2]. Generally, an AR system has the following three properties [3]

- Combines real and virtual objects in a real environment;
- Runs interactively, and in real time; and
- Registers (aligns) real and virtual objects with each other.

Mobile Augmented Reality (MAR) applications are AR applications that run on mobile devices and enable users to obtain the service via the mobile device interfaces.

It is essential to understand the distinction between AR and Virtual Reality (VR) and their placement in the continuum of real to virtual environment defined in [4]. AR is the part of Mixed Reality (MR) where the surrounding environment is real, and that real environment is enriched with augmentations. Conversely, in both augmented virtuality and virtual environment/VR, the surrounding is virtual. Figure 1 presents the real to virtual continuum.

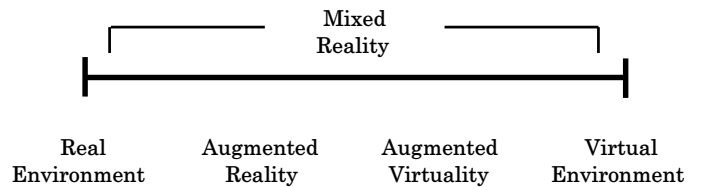

Fig. 1: Miligram and Kishino’s Reality-Virtuality Continuum [4].

In general, a MAR application has inputs, processing functions and produces outputs [5] as depicted in Figure 2.

- **Inputs:** Includes various sensors of the device or any other companion device.
- **Processing:** The collection of functions that generates the output to be displayed on the mobile device’s screen.
- **Outputs:** The action of augmenting, which projects the virtual content on the present view of the real environment.

Different types of input devices are cameras, microphones, gyroscopes, GPS or any other companion devices including wearable devices which consist of multiple inbuilt sensors [5] such as touch inputs [6].

The AR device itself may process the input stream or hand it over to a separate entity such as a cloud server, MEC server or a fog server.

Different AR architectures exist based on the deployment of the processing function. Several processing techniques called

TABLE I: Summary of Important Acronyms

Acronym	Definition
3GPP	3rd Generation Partnership Project
4G	4th Generation wireless networks
5G	5th Generation wireless networks
5GC	5G Core
6DoF	6 Degree of Freedom
ABE	Attribute Based Encryption
AES	Advanced Encryption Standard
AI	Artificial Intelligent
AR	Augmented Reality
BBU	Baseband Unit
CMOS	Complementary Metal Oxide Semiconductor
CU	Central Unit
D2D	Device-to-Device
DDoS	Distributed Denial of Service
DU	Distributed Unit
DVFS	Dynamic Voltage and Frequency Scaling
E2E	End-to-End
eMBB	enhanced Mobile Broadband
EPC	Evolved Packet Core
ETSI	European Telecommunications Standards Institute
FPGA	Field Programmable Gate Array
gNB	Next generation NodeB
GPS	Global Positioning System
GSMA	Global System for Mobile Communications Association
HDR	High Dynamic Range
HMD	Head-Mounted Display
IAR	Industrial Augmented Reality
IoMT	Internet of Medical Things
IoT	Internet of Things
ITU	International Telecommunication Union
L5GO	Local 5G Operator
LTE	Long Term Evolution
MAC	Media Access Control
MAR	Mobile Augmented Reality
MEC	Multi-access Edge Computing
MIMO	Multiple Input Multiple Output
ML	Machine Learning
mMTC	massive Machine Type Communication
MNO	Mobile Network Operator
MR	Mixed Reality
NF	Network Function
NFV	Network Function Virtualization
NR	New Radio
OFDM	Orthogonal Frequency Division Multiplexing
OST	Optical-See Through
PDS	Personal Data Stores
QoE	Quality of Experience
QoS	Quality of Service
RAN	Radio Access Network
RAN	Radio Access Network
RFID	Radio Frequency Identification
RRH	Remote Radio Head
SDN	Software Defined Networking
TTI	Transmission Time Intervals
UDN	Ultra Dense Network
UE	User Equipment
URLLC	Ultra-Reliable and Low Latency Communication
UWB	Ultra-wideband
VR	Virtual Reality
VST	Video-See Through
ZSM	Zero touch network and Service Management

tracking, rendering, interaction, calibration and registration contribute for a useful AR experience. Tracking determines the current pose information to enable the alignment of virtual content on the physical objects. Tracking techniques are categorized into sensor-based, vision-based and hybrid tracking techniques [7]. Sensor-based tracking systems rely on optical, acoustic, mechanical and magnetic sensors [8], whereas vision-based tracking systems use camera feed and image

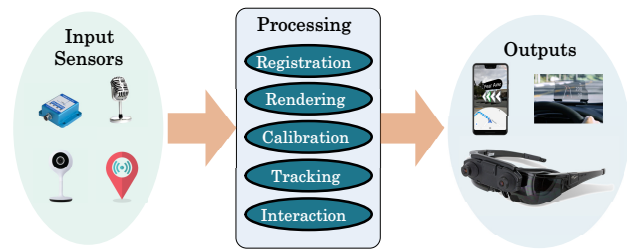

Fig. 2: Components of a Generic AR System.

processing techniques to determine the current pose relative to the real world objects [9]. Vision-based tracking is further divided into marker-based [10] and markerless [11] (also called as natural feature tracking) where a “marker” is an image or view of a real-world object that provides a unique pattern. “Markers” can be captured by an AR camera and recognized by AR software [12]. Intuitively, hybrid tracking systems combine several sensing technologies to make the tracking process more robust such as the tracking system based on GPS, inertial and computer vision sensing [13]. Rendering technique specifies the digital content to trigger when something is recognized. Upon recognizing a particular object, the rendering function generates the relevant content for the display output. Rendering is becoming a computationally-intensive process because of the requirements of present real-time AR applications. Therefore, it is preferable to offload rendering to powerful computing platforms such as the cloud. Calibration and registration techniques precisely align the real-world view with the virtual objects when the user view is fixed, and interaction techniques specify how the user can manipulate AR virtual content [7]. Interaction uses various interfaces such as acoustic, tangible and text-based to interact with virtual objects [14].

AR displays present visual output to the user. The main types of AR display technologies are see-through Head-Mounted Displays (HMD), projection-based displays [15], [16], and handheld displays [17]. See-through HMDs are further divided into two categories called Optical See-Through (OST) which allows the users to see the real world using their natural eyes with overlaid graphics [18], and Video See-Through (VST) where user can see a video view of the real world with overlaid graphics [19]. In addition to the visual output, audio output and haptic feedback [20] are also possible with specific AR devices.

A. Recent Advancements of AR towards MAR

Even though the concept of AR has been there for over two decades, recent technological advancements have transformed the concept into a reality that aids users in their regular lives. Those technologies include computing hardware and software, wireless communications and networking, displays, and wearable devices [21]. Recently, AR became popular in numerous application areas, including industry, healthcare, entertainment, and education and training [22]. Expanding AR capabilities to mobile devices such as general mobile phones and wearable devices realizes further benefits from the technology [23]–[26]. The navigational capabilities and the

situational awareness of mobile devices, enrich the features of MAR applications to serve the user in a sophisticated manner. MAR is part of the AR that users can take with them wherever they go, and the distinction of MAR against the portable AR is that MAR allows users to conveniently access the services using mobile devices anytime anywhere [27]. Existing literature discusses the characteristics of AR and MAR and the fundamental properties that distinguish MAR from AR as summarized in Table II and illustrated in Figure 3. Google Glass [28], which was first commercially available in 2014, was one such product that demonstrated the enhanced user experience envisioned in the future [29], [30]. Since then, the technology has been evolving and available to widespread of users in the mobile phones via many applications such as Pokemon Go [31], Google Lens [32], and in recent wearable devices such as Microsoft HoloLens [33].

TABLE II: Key Characteristics Comparison of AR and MAR

Property	Augmented Reality	Mobile Augmented Reality
Mobility aspect [27]	Not necessarily fixed to one location. Portability is possible. However, using the full AR functionality while moving is unrealistic. E.g. An AR application running on a laptop which takes AR input from front camera.	Users are capable of experiencing the full AR functionality while moving. E.g. Google Glass, AR applications in mobile phones.
Task processing [34]	Devices can be equipped with GPUs to perform heavyweight computer vision on-device.	Mobile devices may not have sufficient computational capability to perform suitable computer vision for immersive MAR. May require computational offloading.
Device energy consumption [35]	Optimization for energy consumption is not as critical as MAR since power supply can be provided externally.	Each component as well as the overall system should be designed to mitigate excessive power consumption because rich functionalities drain the batteries fast.
Device form factor [36]	Not necessarily a major design concern.	Should be less bulky, easy to handle while delivering the required functionality.
Operability in ubiquitous environments [37]	Mostly needed to work in given environment such as a confined room.	Essential to operate in ubiquitous environments. E.g. Under different lighting conditions, in noisy environments.

Limited battery life and processing power of devices impose constraints on the realization of MAR, as AR technology emerges into mobile devices. Offloading the computationally intensive process to remote servers such as cloud [38]–[41] provides a viable countermeasure. Remote offloading adds transport delay, which is not tolerable by ultra-low latency AR applications. Multi-access Edge Computing (MEC) brings the computations closer to the end devices, minimizing the latency of cloud offloading and facilitating the latency-critical applications [42]–[45]. Mobile edge computing offers the processing capabilities at the nearest base stations, provides a promising approach to offload MAR computations via the radio network [46]. The envisioned future of MAR puts strict requirements on wireless connectivity, which can be realizable

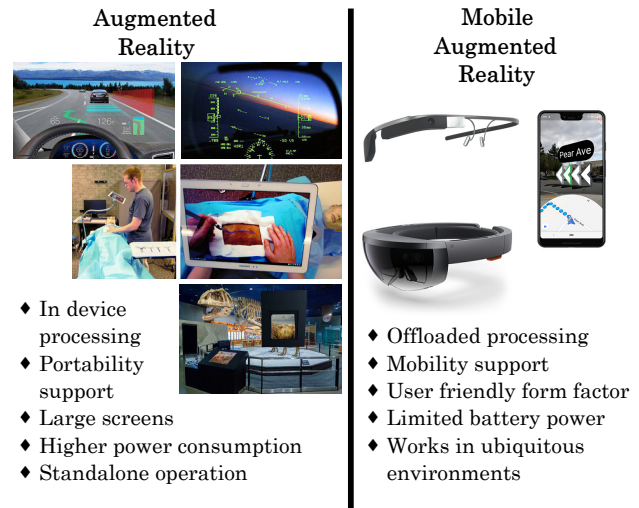

Fig. 3: Augmented Reality vs. Mobile Augmented Reality.

via sophisticated communication systems like 5G systems.

B. Paper Motivation

The technology related to AR was primarily discussed decades ago, and the first sort of AR device was built in 1968 [47]. The technology was properly named “Augmented Reality” in 1990 [48]. However, AR has been widely recognized as a research field since 1997. A survey published in 1997, defined the field, explained the problems and summarized the developments [49]. Since then, multiple surveys on AR focused on various aspects such as applications of AR and the limitations regarding human factors [22], tracking, interaction, display, rendering, calibration and registration research during 1997 - 2008 [7], the impact of different mobile and wireless technologies [21]. After 2010, the surveys focused on problems and difficulties encountered during building AR applications [50], potential or current uses of MAR applications [51], challenges in AR [14], current technologies, future trends and main application domains [52], issues related to the development of technologies and applications [53]. A survey on MAR [5] in 2017 presented details on more recent applications fields, core components of a MAR system, advances in tracking and registration, network connectivity and its importance to performance, and the present challenging problems. This survey is the only survey to briefly discuss how future 5G systems will help to build more sophisticated AR applications. The summary of the information contained in previous surveys is shown in Table III.

MAR technology will revolutionize the way information is presented to people in the future [54]. With the advancement of wireless communication technologies with future 5G systems [55], the network level limitations will be diminished, enabling practical MAR systems. Moreover, the business potential of MAR has been widely recognized. The latest report published by Market Research Future Reports (MRFR) on the augmented reality and virtual reality has mentioned that the market is estimated to reach USD 766 billion by 2025, registering a Compound Annual Revenue Growth (CAGR) of 73.3% during the forecast period of 2018 to 2025 [56]. The

TABLE III: Summary of available AR Surveys

Ref, Year	Main Contributions	Application Areas
[22], 2007	Discusses the limitations of portability and outdoor use, tracking and auto calibration, latency, depth perception, adaption, fatigue and eye strain, overload and over reliance, and social acceptance.	Personal information systems, industrial and military, medical, AR for entertainment, AR for office, and education and training.
[21], 2008	Compares features such as range, resolution, time before drift and environment of each tracking technologies e.g., magnetic, ultrasound, inertial, accelerometer, Ultra Wide Band (UWB), optical, hybrid, GPS and wi-fi.	Virtual character-based applications for AR, cultural heritage, edutainment and games, navigation and path-finding, collaborative assembly and design, and industrial maintenance and inspection.
[50], 2011	Provides a comparison of different techniques for different types of displays. Display types include head mounted, handheld and spatial and techniques include video-see-through, optical-see-through and direct augmentation. Presents range, setup time, precision and environment of the tracking technologies such as optical, GPS, wi-fi, accelerometer, magnetic, ultrasound, inertial, hybrid, UWB and RFID.	Advertising and commercial, entertainment and education, medical, and mobile applications.
[51], 2012	Analyzes the trend of AR towards MAR considering certain application areas.	Sport, games and edutainment, cultural heritage, medical, education and training, and marketing and advertising.
[14], 2013	Discusses performance, alignment, mobility, interaction, and visualization challenges.	No discussion on applications.
[52], 2016	Discusses application areas of AR. Provides an overview of current technologies and future trends of AR.	Medicine, assembly maintenance and repair, entertainment, sports and marketing, collaborative visualization space, tourism, architecture and construction, cultural heritage and museum visits, teaching education and training, and military.
[5], 2017	Challenges and Limitations. Presents technological limitations, security and privacy, and social acceptance as challenging problems. Analyzes runtime performance, energy efficiency, and performance vs. energy efficiency. Discusses different methods of computational outsourcing to make the end devices energy efficient.	Tourism and Navigation, entertainment and advertisement, training and education, geometry modeling and scene construction, assembly and maintenance, information assistant management, representative MAR applications, and big data driven MAR.
[53], 2017	Presents a broad categorization of displays called HMD, large displays, small displays, and hand-held displays. Classifies tracking techniques into sensor-based, vision-based, and hybrid domains.	Training and education, entertainment and commerce, navigation and tourism, and medical and construction.

wide adoption will ensure the availability of MAR systems to the general public at an affordable cost.

The most recent comprehensive survey on AR is conducted in 2017. Except for recent surveys, the past surveys rarely focus on the communication aspects of AR. While the increased penetration of wireless communication technologies persuades the public adoption of MAR, sophisticated future applications will demand diverse and strict requirements. Due to the limited inbuilt processing capabilities of wearable MAR, data processing and transmission will undergo drastic changes. In this context, a comprehensive analysis of the communication aspects of MAR should be conducted, addressing the gaps of the knowledge built by past surveys. Serving a set of use cases having versatile requirements using a uniform network architecture is not practical. Multiple MAR network architectures will be used in the future based on diverse application and user requirements. Various technical aspects will play essential roles in realizing these future applications. Therefore, we believe that a thorough study must be conducted considering the MAR applications, network architectures and technical aspects before attempting the real implementations.

C. Contributions of the Paper

The future MAR systems will exhibit substantially different characteristics compared to present MAR devices, especially with the advent of 5G systems and edge computing. These systems expected to utilize the networked intelligence to provide far better experience instead of operating as a collection of standalone MAR devices. Availability of comprehensive

knowledge on future MAR landscape is a must before the real implementations. To the best of our knowledge, no existing survey discusses the advancement of MAR relating to the key 5G deliverables. The main objective of this study is to produce a comprehensive knowledge of the coexistence MAR applications, 5G technologies and MEC systems. The survey outlines the future network architectures for MAR, presents and analyzes the properties of key application areas and technical aspects, highlighting the significance of 5G and MEC.

The contributions of the paper are listed below:

- **Present the landscape of MAR:** A comprehensive study on the evolution of AR systems into MAR systems, the state-of-the-art literature, and the future potential of MAR.
- **Discuss architectural options for future MAR systems:** Present knowledge on potential architecture options such as cloud based, edge based, localized and hybrid to realize application requirements, along with their advantages and disadvantages.
- **Discuss the importance of 5G for future MAR:** Discuss MAR in pre-5G era, the envisaged future, and how the advancement from 4G to 5G facilitates future MAR. Present key 5G features, such as mmWaves, small cells, beamforming, massive MIMO and complementary technology MEC, to realize MAR with 5G.
- **Discuss key application areas for MAR:** Present the application areas for MAR and the current implementations. Discuss the future of the applications and how 5G

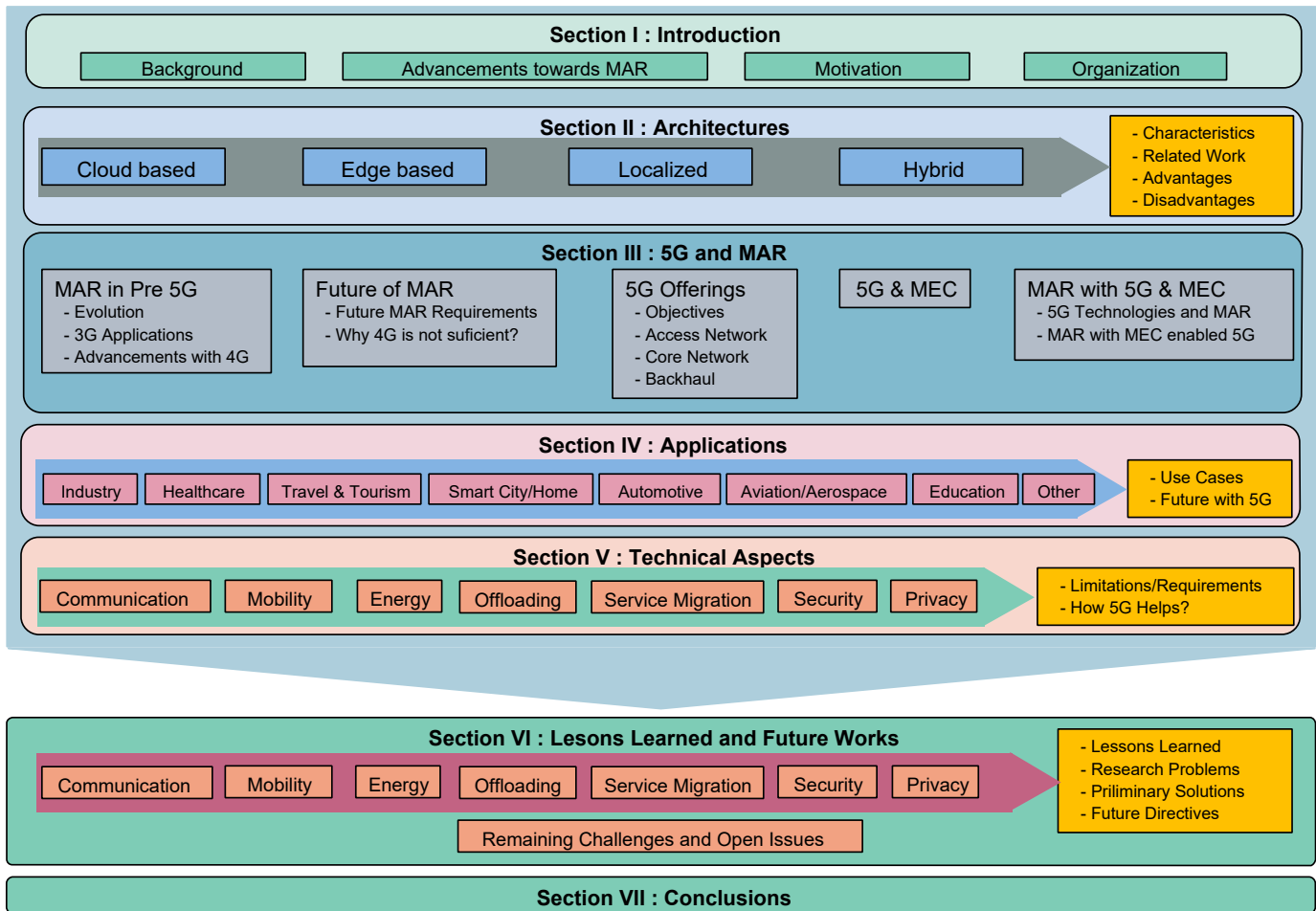

Fig. 4: Outline of the Paper.

will facilitate in realizing the future use cases under the application areas.

- **Identify and discuss technical aspects of 5G MAR systems:** Discuss different technical aspects relevant to future MAR systems, their significance, requirements, limitations and role of 5G under each technical aspect.
- **Present lessons learned and future research directions:** Based on the findings, highlight the lessons learned, current research problems, preliminary solutions to address these problems and possible research directions for future 5G MAR systems.

D. Paper Organization

The remainder of the paper is organized as follows: Section II describes the architecture options for the MAR systems based on MAR client and server deployments. These include cloud based, edge based, localized and hybrid architectures. Section III discusses the MAR in pre-5G era, envisioned future MAR landscape, the novel technologies introduced by 5G and how future MAR benefits from 5G and MEC. Section IV explains the different application areas and use cases of MAR systems including Industry 4.0, healthcare, travel and tourism, smart city and smart home, automotive, and aviation and aerospace. It also elaborates how the future of each

application area will be shaped by 5G and MEC. Section V describes technical aspects related to MAR system including communication, mobility management, energy management, service offloading, service migration, security and privacy. The discussion further considers the role of 5G technologies under each technical aspect. Section VI presents the lessons learned, current research problems, preliminary solutions and future research directions. Finally, Section VII concludes the paper. The outline of the paper is depicted in Figure 4. Definitions of frequently used acronyms are provided in Table I.

II. ARCHITECTURE OPTIONS FOR MOBILE AUGMENTED REALITY

This section presents potential network architectural options of existing and future MAR systems. Stringent requirements of the present and emerging MAR applications and the improvements of different technologies together enable these architecture options including cloud based, edge based, localized and hybrid. The categorization is based on the location where the core AR processing functionality is placed. Different architectures were derived based on whether the AR function is hosted at a cloud server, edge server, local server, within the client AR device or in a mix of above to fit the application requirements. This section also summarises the related work

under each architecture and compares the advantages and disadvantages of each architecture.

A. Cloud based Architecture

In the cloud based architecture, the MAR system operates in a client-server model. MAR devices which execute the terminal applications are called clients. AR server is located in the cloud and accessible from anywhere via the Internet. The devices capture the images, carry out minimal mandatory processing, transfer the images to the server and display the augmentations received from the server. Cloud AR server performs more computationally intensive tasks of image processing [57]. The generic cloud based system architecture is illustrated in Figure 5.

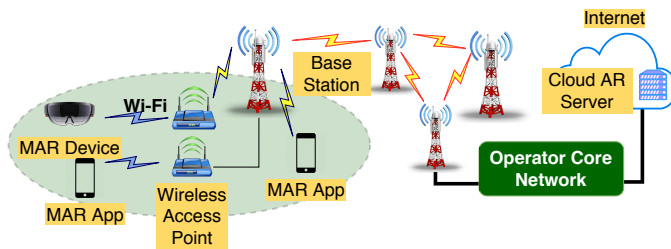

Fig. 5: Cloud based System Architecture for a MAR System.

A MAR system that identifies books via the captured images [58] has a cloud based implementation. Once the user directs the device camera to a known identifier in the book cover, the application provides further details about the book on the screen. As the application is not latency critical, cloud offloading is a viable option. Other cloud based MAR applications include indoor and outdoor navigation [59], collaborative urban design, multi-user interactive motion learning systems [60], city sightseeing [61], medical training [62] and AR enhanced education for students having special needs [63]. Certain cloud based MAR applications utilize complex algorithms to reduce the data transfer towards the cloud, aiming to minimize the latency [64]. Moreover, certain other cloud based MAR systems perform most of the operations locally to achieve low latency [65] and offload the images to the cloud only when necessary. The purpose of the cloud offload is to calibrate its internal localization results; hence this system has minimal offloading overhead.

1) Advantages of Cloud based Architecture

A client server MAR system usually offloads the processing to the server since it has high computational resources. MAR devices perform only mandatory pre-processing tasks such as image compression/coding. Therefore, these devices are called as “thin clients” [66]. Other than achieving a longer battery life for the MAR devices, offloading devices can be made lightweight to be easily handled or worn by the users. Due to the minimal processing at the device level, the administration of the system is easy. For example, upgrading the core image processing software is much easy to perform in the server, rather than upgrading all the terminal devices. Like software upgrades, core AR software troubleshooting is easy to apply in the cloud, rather than fixing each device.

2) Disadvantages of Cloud based Architecture

The main disadvantage is the increased communication latency. The radio delay of the wireless system and the delay of the backhaul links are aggregated to form the one-way End-to-End (E2E) latency of the MAR system. A cloud based MAR system has a single point of failure, i.e., if the cloud AR server fails, the entire system fails. The cloud based MAR architecture heavily depends on the condition of the infrastructure, therefore shows high jitter. During network congestion, the E2E latency increases and fails to satisfy the application service level requirements. A failure of any infrastructure link may also affect the performance of the system. Security and privacy threats are also higher because the data is transferred outside the client locations, usually via public networks. The sensitive information is more vulnerable to attacks than in a standalone system.

B. Edge based Architecture

Certain MAR use cases require ultra-low latency which the cloud based architecture does not guarantee. Edge computing is the most suitable computing paradigm [67] to serve those use cases. Edge based architecture also operates as a client-server model where the AR server is hosted at the network edge. Terminal MAR devices perform the same minimal functionality as in the cloud based architecture. AR server executes the computationally intensive tasks such as pre-processing, AR tracking and rendering the augmentations. The generic edge based architecture for an AR system is depicted in Figure 6. The purpose of the Internet connectivity is to facilitate actions such as upgrading device software but does not involve in core AR processing which requires ultra-low latency. Similar to cloud based architecture, lightweight and energy efficient MAR devices can be used with edge based architecture due to computational offloading. However, edge based architecture is more suitable to serve latency critical applications.

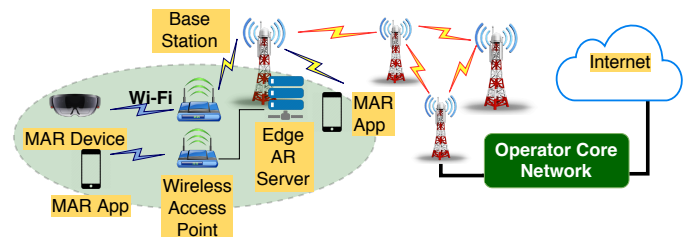

Fig. 6: Edge based System Architecture for a MAR System.

An edge based architecture for driver assisting AR system [68] comprises three layers called device layer, access network layer and core network layer. The device layer consists of AR clients, and the edge servers are located in both the access network and core network levels. The edge servers at the access network level serve the latency sensitive applications. The edge servers at the core network provide a large scale of services. The optional cloud is used as a data backup and does not actively involve in any AR communications. Edge servers allow caching of popular content in addition to data processing, enabling dynamic adaptability of AR/VR

applications [69]. A latency minimization resource allocation for a multi-user AR system [70] proposes a MEC based data sharing model for AR task processing to achieve minimized latency. Vehicular AR networks are also benefited by edge based AR architectures [71], as they require ultra-low latency.

1) Advantages of edge based Architecture

Reduced E2E latency is the main advantage compared to cloud based architecture due to the proximity of edge servers. The AR function depends less on the infrastructure links than the cloud based architecture as the server is deployed at the edge. Edge servers ensure more reliable communication than cloud based architecture. Content caching is possible because of the localized nature of the information. Content caching reduces the E2E latency and congestion in the infrastructure network beyond the edge server. The user data does not transfer over a public network, ensuring more secure communication. Lightweight and energy efficient MAR devices such as wearables can be supported with edge based architecture as it supports computational offloading.

2) Disadvantages of edge based Architecture

Single point of failure is a drawback since a failure of edge AR server affects the entire system. Edge based architecture needs distributed server resources in geographically distributed use cases. An example would be two distant branch locations of a factory which uses the same AR functionality. In a cloud based architecture, the same requirement could be served from a centralized cloud server, but the edge based architecture preferably needs two servers at respective network edges. In such cases, the deployment of the MAR system is time consuming and costly. The higher operational overhead compared to cloud based architecture is also a drawback. Activities such as server upgrades are centralized in cloud based architecture, while edge based architecture requires more effort to perform upgrades.

C. Localized Architecture

The paper presents two options for localized architecture. The first option deploys the AR server very close to the MAR devices as depicted in Figure 7, preferably in the same locality with the MAR devices. The MAR devices and the AR server are connected to the nearest base station. The connectivity is likely be established via wireless links. The server executes the computationally intensive tasks while MAR devices perform a limited set of mandatory processing.

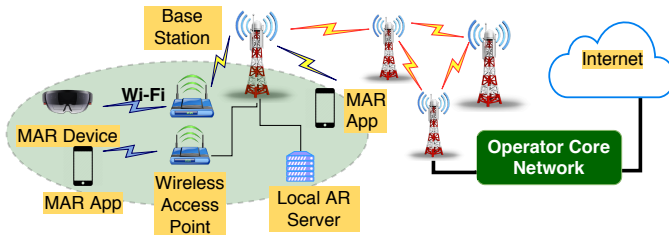

Fig. 7: Localized System Architecture for a MAR System using a Dedicated AR Server.

Alternatively, the AR server can be eliminated, as depicted in Figure 8. In this case, the MAR device performs the series of

processing functions including image capturing, perform AR tracking, render augmented image and display it on its screen. Here, MAR device acts as a standalone system, as the device itself handles all the processing required by the application. The Internet is required for management, backup and software upgrades.

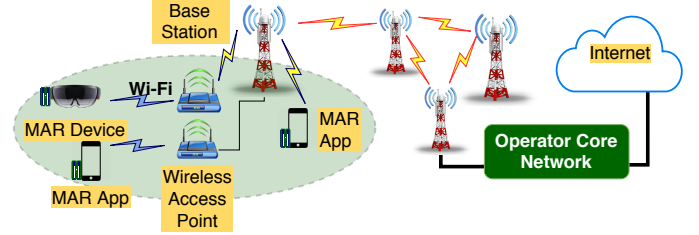

Fig. 8: Localized System Architecture for a MAR System using only MAR Devices.

Handheld device based AR applications are used in sports, games and edutainment, cultural heritage, medicine, education and training, marketing/advertising [51] and indoor navigation [72]. The evolution of modern general mobile devices facilitates the development of sophisticated AR applications addressing the past limitations [73]. An android based MAR application that supports interior decoration [74], uses the in-built sensors of a smartphone to perform entire AR processing. The device based MAR has limitations in processing power and battery life, which can be addressed by adopting a different architecture such as cloud based or edge based architecture.

1) Advantages of Localized Architectures

The MAR system with a local server achieves significantly lower latency compared to the cloud based approach. Moreover, the AR data stays within the premises. Hence the data is less vulnerable to security attacks, and privacy threats are comparably low. The regular administration tasks such as server upgrades, client setups are easy because the entire system is deployed locally. The system does not depend on the condition of infrastructure links ensuring more reliability.

Ultra-low latency is the main advantage of the second approach as the entire AR operation is performed within the MAR devices. The system is independent of the infrastructure, and the data used for AR processing stays within the device. Moreover, this architecture provides the lowest vulnerability to security attacks and has the highest privacy protection.

2) Disadvantages of Localized Architectures

Even though the AR server is hosted locally in the first approach, the latency will be higher than the edge based architecture if the server is connected to the base station wirelessly. Single point of failure still exists as the server hosts the AR processing functions.

Shorter battery life is the main disadvantage of the second approach. As the device performs the entire activity spectrum needed for processing, the energy consumption is highest compared to other architectures causing the batteries to drain fast. As the terminal MAR devices possess less computing power than the cloud, edge or local servers, this architecture is not suitable for complex MAR applications. Device restrictions limit the number of applications supported by the standalone

MAR architecture. Any additional hardware used to increase the battery power or computing power makes the devices bulky and heavy. Continuous use of bulky and heavy devices is operationally challenging. Administrative activities such as software upgrades and troubleshooting must be performed on each device. Absence of centralized control is also a drawback in a multi-device system.

D. Hybrid Architecture

A hybrid architecture for a MAR network has a cloud node and an edge node along with the client AR network. The latency critical interactive MAR functions should be executed at the edge node since the overall network latency directly relates to the length of a signal path and the number of intermediary routing/switching elements. Conversely, the applications not requiring ultra-low latency are hosted at the cloud node. The control functions and the management functions may be performed at the cloud node or the edge node. These functions include control plane signalling, service flow processing, policy scheduling and capability opening, and network operation and maintenance, node management and slice management [66]. These functions have no direct impact on the interactive nature of the MAR experience. The edge node is responsible for user plane functions that assure the ultra-low latency requirements of the MAR applications. The hybrid architecture is depicted in Figure 9.

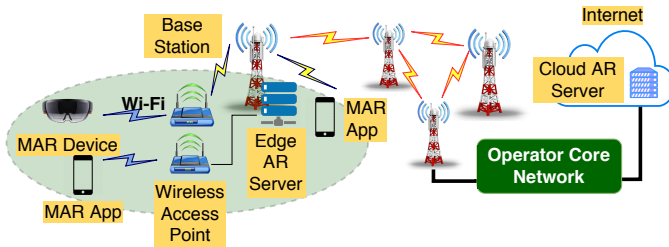

Fig. 9: Hybrid System Architecture for a MAR System.

A hierarchical architecture to serve the AR applications [75] comprises an edge layer between the conventional user layer and the cloud layer. User layer has multiple AR devices equipped with wireless connectivity to the edge layer. The cloud layer maintains a database and abundant computational resources. The edge layer consists of three modules called communication unit, operation platform and virtualized controller. The combination of the three modules ensures the convergence of communication, computation and control. A fog computing and cloudlet based AR system for the Industry 4.0 shipyard [76], [77] consists of three layers, i.e., the node layer, edge layer and the cloud. The node layer consists of Industrial Augmented Reality (IAR) devices. The edge layer consists of a local gateway used for data caching for sending content to IAR devices and a cloudlet capable of carrying out computations requiring low latency. The cloud hosts services that require more processing power. A MEC-based collaborative web AR solution which has the complimentary edge and cloud servers [78], reduces the network latency while decreasing the bandwidth usage of core networks. The edge

server consists of MEC application platform, Web AR runtime environment and Web AR applications. An IAR system in an Industry 4.0 shipyard [79] is based on a fog computing architecture which comprises three layers called node layer, fog layer and cloud layer.

1) Advantages of Hybrid Architecture

Reduced latency is the main advantage over the cloud based architecture due to edge processing. Edge processing reduces the application dependency on the infrastructure links ensuring more reliable communication. In a case where most of the information is highly localized, caching at the edge servers reduce the E2E latency while decreasing the congestion at the infrastructure network beyond the edge server. The hybrid approach has better security and privacy than the cloud based architecture because the data stays close to the terminal devices. Hybrid architecture also has advantages over the edge based architecture. Edge server has less control overhead because the cloud server processes the control messages. Cloud based control offers a more centralized approach in comparison with edge based controlling. Energy consumption of the terminal devices is lower compared to the localized architecture, as the devices perform only the mandatory operations.

2) Disadvantages of hybrid Architecture

Since the cloud handles the control functions, and the edge handles the interactive AR functions, the single point of failure still exists. The system does not function properly if either the edge server, cloud server or the infrastructure network fails. A hybrid architecture is generally more complex than the other architectures. Therefore, the effort for the initial design, operational overhead, and the administrative overhead is higher.

E. Summary of MAR Architecture Options

The selection of the most suitable architecture for a MAR system depends on the requirements of the applications. The localized architecture is not a preferred option for many use cases, and not widely considered in the literature. The reasons are twofold. The underlying processing functions should be sophisticated to produce a better experience with an AR system. It requires more computing power for execution, causing the batteries of mobile devices to drain fast. MAR devices have limited battery power, and frequent charging is an operational overhead. Equipping MAR devices with larger batteries make them bulky, heavy and less user friendly. Secondly, the network level limitations are diminishing and paving the way to achieve ultra-low latency in communications. The high speed Internet connectivity makes computational offloading a viable option. Therefore, cloud based and especially edge based architectures are suitable to provide the required ultra-low latencies for MAR applications. A mapping of different AR applications against the possible architecture options is depicted in Figure 10. A comparison of properties, advantages and disadvantages of all the architectures discussed in Section II are summarized in Table IV.

III. 5G AND MAR

This section presents AR in pre-4G era and potential MAR network architecture changes from 4G to 5G. Moreover, it



Fig. 10: Applicability of different Architectures based on the Characteristics of MAR Applications.

describes the novel 5G technologies introduced to access, backhaul and core networks, and the complementary technologies such as MEC, Software Defined Networking (SDN), Network Function Virtualisation (NFV). The section discusses how these technologies together help to realize future MAR. Finally, it emphasizes how the coexistence of MEC and 5G can be used to serve future MAR and how it brings distinguished benefits.

A. MAR in pre-4G era

The underlying technologies and concepts defining AR have been in development for decades. However, the practical adoption of AR systems was limited due to technological constraints. As AR technology in mobile devices gets popular, MAR placed strict demands on wireless communication and networking. Even though there were portable and standalone AR devices in operation during the past, the high bandwidth and low latency requirements of a MAR system could not be satisfied by the first two generations of wireless communication technologies. With HSPA+ in 3G systems, maximal downlink throughput revolved around 7 Mbps while the upload is constrained around 1.5 Mbps in the practical implementations [93], still with significant variations over time. The latencies also varied and could reach up to 800 ms [93]. With these capabilities, HSPA+ can cater for a limited set of MAR applications, such as Pokemon Go [31], IKEA Place [98], educational applications and games. 3G connectivity does not provide sufficient bandwidth or low-latency required by

complex MAR applications.

B. MAR with 4G

The present 4G Long Term Evolution (LTE) systems have shown substantial improvements over the previous generation in bandwidth and latency. The practical implementations exhibited average throughput around 19.61 Mbps on the downlink and 7.94 Mbps on the uplink [93]. The minimum latency of LTE networks is 10 ms [99]–[101]. Therefore, LTE networks are likely to satisfy the requirements of more advanced MAR applications than 3G networks. Examples include AR mode of Google Maps [81], games, retail applications, education applications [102].

Wearable device-based MAR (e.g. Microsoft HoloLens [33], Google Glass [28]) and app-based MAR (e.g. Pokemon Go [31]) are the popular types of MAR applications in the current context with 4G networks. App-based MAR is usually iOS or Android applications installed on general mobile devices. Currently, the device-based MAR either operates standalone or usually connects to the Internet via Wi-Fi connections. App-based MAR can operate standalone, directly connect to 4G network or utilize Wi-Fi connectivity as the access method. The general system architecture of a cloud based 4G MAR system is represented in Figure 11a.

C. Future of MAR

Mobile communication systems up to 4G networks can deliver a reasonable experience to the MAR users, addressing

TABLE IV: Comparison of Different Architectural Options for MAR

Item	Cloud based	Edge based	Localized	Hybrid
Nature of Applications	Suitable for centralized applications used by vast number of distributed users.	Suitable for more localized requirements.	Server based architecture is suitable for highly specialized and isolated applications, with multiple devices. Local on device architecture is suitable for isolated applications with strict security	Suitable for applications requiring low-latency and centralized control simultaneously.
Existing and Potential Examples	Remote training, AR enhanced Google Maps, translation apps [80]–[82].	Indoor/localized navigation, industry monitoring using MAR [83]–[86].	MAR based military training in a training camp [87], Military aircrafts, pilot training, AR enhanced windshield in a racecar [88]–[90].	Remote surgery [91].
AR Server Location	Cloud	Network edge	Local network or on-device	Network edge
Latency	< 50 ms [92]	< 20 ms [91], [93], [94]	< 20 ms for server based [91], [93], [94] and < 5 ms for local on-device [66]	< 20 ms [91], [93], [94]
	Communication latency is higher than other architectures due to the cloud AR server deployment.	Applications require ultra-low latency.	Applications require ultra-low latency having the key requirement of keeping the data locally.	Applications require ultra-low latency with a centralized controlling possibility.
Security Vulnerability and Privacy Threats [5]	High Involves remote servers over public networks [95].	Medium Data processing happens closer to the MAR devices and exposure to public network is less [96].	Very low Data stays within the premises/device.	Medium Critical data processing happens closer to the MAR devices. Few information is sent via public networks [75].
Operational Overhead	High Management of cloud server and MAR devices is required [59], [65].	High Management of edge servers and MAR devices is required [68], [71].	Low Only local server and MAR devices are involved for server based setup. On-device setup need each device individually [72], [73].	Highest Management of cloud server, edge servers and MAR devices is required [75]–[77].
Functionality of client MAR Device(s) [59]	Mandatory pre-processing (encryption, compression and coding).	Mandatory pre-processing (encryption, compression and coding).	Mandatory pre-processing at the device for server based architecture. Entire processing for on-device setup.	Mandatory pre-processing (encryption, compression and coding).
MAR device Energy Consumption [59], [97]	Low Due to computational offloading.	Low Due to computational offloading.	Low for server based setup and very high for on-device setup Based on the level of processing at the device	Low Due to computational offloading.
Scalability in terms of supported MAR devices	Very high Cloud-based MAR applications support higher number of devices [81], [82].	Typically 1-100 Depends of the resources of edge servers [94].	Typically 1-100 for server based architecture Depends of the resources of local server.	Typically 1-100 Depends of the resources of edge servers, public network and cloud servers [76], [77].

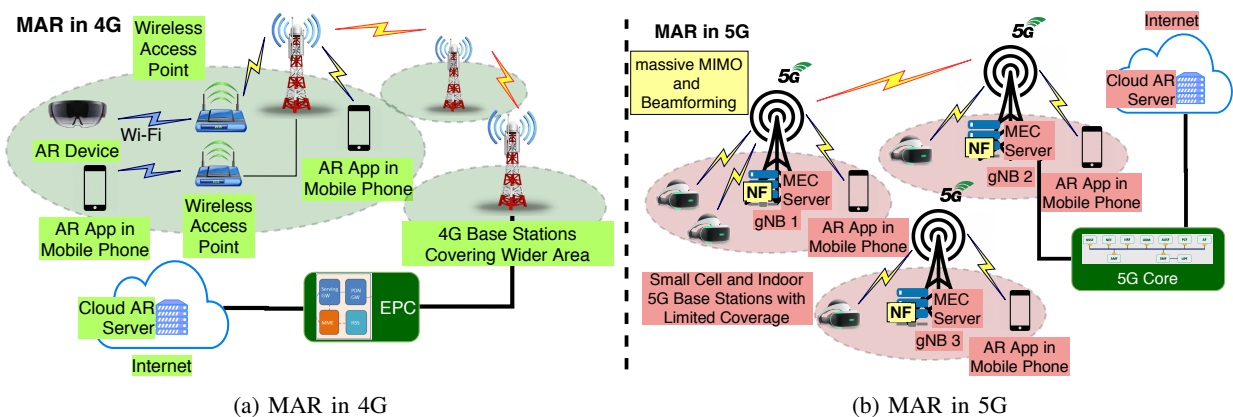

Fig. 11: Comparison of Network Architectures for MAR.

the expectations only up to a certain level. However, the envisioned future of MAR is far beyond what has already been seen. The next generation of video includes new formats, such as stereoscopic, high dynamic range (HDR), and 360°, at increased resolutions (8K+) and higher framerates (90+ fps). A stereoscopic HDR 360° video used in AR/VR at 8K 90 fps with HEVC video codec requires a data rate higher than 200 Mbps. A 6 Degree of Freedom (6DoF) video that allows translational movement requires a data rate from 200 Mbps to 1 Gbps per user [92]. A 3GPP study on communication services for critical medical applications emphasizes that AR assisted surgery [91] requires E2E latency less than 1 ms and 12 Gbps data rate for a compressed 4K 120 fps High Dynamic Range (HDR) 10 bits real-time video stream.

These bandwidth and latency requirements are beyond the offerings of 4G systems. The use of wired networks is also impractical due to user mobility in many AR use cases. AR services offered via mobile devices impose additional requirements on device battery life. The use of non-3GPP access methods such as Wi-Fi is questionable due to performance anomaly, low reliability, handover issues [93]. Hence, the future MAR systems should be leveraged with an advanced communication infrastructure, such as the one proposed by the 5G systems. Key 5G technologies must be used to realize future MAR applications, mainly focusing the high data rates and ultra-low latency requirements [103].

D. What 5G Offers

As the last four generations of cellular technology, 5G will be a paradigm shift from present wireless communications technologies. It will also be highly integrative to provide universal high-rate coverage and a seamless user experience [104], [105]. The Mobile and wireless communication Enablers for the Twenty-twenty Information Society (METIS) project has derived 5G requirements into five technical objectives. They are 1000 times higher mobile data volume per area, 10 to 100 times higher number of connected devices, 10 to 100 times higher user data rate, 10 times longer battery life for low power massive machine communications, and 5 times reduced E2E latency [106]. 5G proposes drastic changes in both access, core and transport networks by introducing novel technologies, to achieve these objectives.

1) Access Network

The key distinguishable technologies used in the access network layer are mmWaves (30-300 GHz), small cell networks, massive Multiple Input Multiple Output (MIMO) and beamforming [104]. The use of mmWave spectrum will limit the cell radius (cell radius up to 200m [107]) of 5G base stations significantly compared with the cell radius of 3G and 4G macro base stations. The mmWave propagation characteristics reveal that these frequencies are more sensitive to blockage effects. Therefore indoor users are unlikely to be served by outdoor mmWave base stations [108]. These two facts lead to the deployment of dense small cell networks, including indoor base stations to provide reliable 5G connectivity. The Ultra Dense Networks (UDN) achieve comparable coverage and much higher data rates than 4G cellular systems [108], [109].

Massive MIMO equips a much higher number of antennas on the base station and combines it with complex algorithms for coordination to achieve drastic improvements in throughput and efficiency [110]. Beamforming technology, combined with massive MIMO focuses on transmitting the signals from the transmit antennas in different desired directions to overcome the unfavourable path loss, guaranteeing the data rate to the user [111]. The shorter wavelengths of mmWaves allow massive MIMO to establish antennas very close to each other and direct their beams using beamforming technology. These technologies together enable much higher data rates in 5G, which is the focus of its enhanced Mobile BroadBand (eMBB) service class [112].

In addition to the provision of higher data rates, latency minimizing is also a critical consideration in 5G systems (i.e., Ultra Reliable and Low Latency Communication (URLLC) service class [112]). To enable extremely low latencies in the range of 1 ms, the entire system should be redesigned [113], including Radio Access Network (RAN), backhaul and storage [114], various diversity sources, design of packets, network topology, access protocols [115]. One design choice for the latency minimization over a radio channel with 5G wireless systems is to use short transmission intervals [114]. 3GPP proposes a new unit of scheduling called a mini-slot, which can be flexibly configured to last between 1–6 Orthogonal Frequency-Division Multiplex (OFDM) symbols [116]. Using mini-slots, the arriving URLLC data can be immediately scheduled by the base station. This approach is suitable only for relatively small data packets and decreases resource efficiency. The excessive number of spatial degrees of freedom in massive MIMO can also be a potential contributor for URLLC [115]. Base station densification leads to resource reuse and increases per user resource allocation, which can be directly utilized for latency reduction [115].

2) Core Network

The development of 5G networks is driven by many future use cases, such as industrial automation, self-driving cars, smart cities, and AR [112]. 5G Core (5GC) network must also be redesigned to serve those use cases [117]. The 5G core network aims to provide simultaneous support for eMBB, URLLC, massive Machine Type Communication (mMTC) with increased flexibility and adaptability than the Evolved Packet Core (EPC) in 4G. The adoption of SDN, NFV, network slicing, and Cloud RAN [117] achieve this evolution. SDN decouples the control and user plane of a network and enables programmable networks. In contrast to EPC, which comprises network elements having both user and control planes tightly coupled together, a clear separation between control and user plane functions will achieve the real flexibility needed in next-generation core networks. 5G introduces the concept of Network Functions (NF) in the core, such as Access and Mobility Management Function (AMF), Session Management Function (SMF), User Plane Function (UPF). NFV defines how NF can be abstracted from the underlying physical infrastructure and deployed as virtual instances in a distributed manner. Virtualized NF share common physical resources of computing, storage and networking, increasing the flexibility of deployment. NS [118], [119] creates logically

isolated networks on a shared infrastructure to enable different types of communication service classes, such as eMBB and URLLC.

3) Backhaul Network

Apart from the access and the core networks, the existence of advanced transport network is also vital. The backhaul is referred to the set of links that connects the access nodes to the core network, and present backhaul is primarily built with microwave links and fiber links [120]. In 4G, The baseband and the radio functions of the cell site has been separated into two entities called Remote Radio Head (RRH) and the Baseband Unit (BBU). RRH is located at the cell site, and BBU is centralized. The interface between RRH and BBU is named Common Public Radio Interface (CPRI), which standardized the transport, connectivity and control specifications between RRH and BBU. The link between RRH and BBU was defined as fronthaul and mainly consists of fibre links, whereas the rest of the transport network is called the backhaul.

With 5G UDN, deploying fiber fronthaul and backhaul is difficult, time consuming and costly [120], [121]. Moreover, diverse 5G use cases call for a flexible fronthaul which balances the throughput, latency and reliability. The CPRI is less flexible to handle the variable traffic demand in 5G era. Therefore it is impractical and expensive to scale the existing transport network to support massive MIMO, high bandwidth, and low latency required by 5G use cases. 3GPP [122] defined the functionality of next generation NodeB (gNB) as a split between two logical units, a Central Unit (CU) and a Distributed Unit (DU). International Telecommunication Union (ITU) [123] adopted a different approach to 5G transport network architecture by defining an additional third element called Radio Unit (RU). The RU implements the RF functions similar to RRH in 4G and DU and CU have the deployment flexibility to yield different network architectures as depicted in Figure 12 [124]. Usually, functions that need real-time processing are grouped within the DU, while those not requiring real-time processing are grouped within the CU. The transport network between the CU and DU is referred to as midhaul.

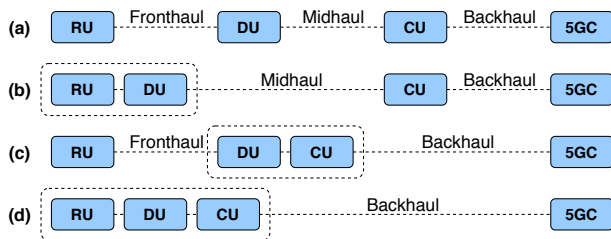

Fig. 12: 5G Fronthaul, Midhaul and Backhaul Combinations [124].

Wireless backhaul is a scalable and cost effective solution to support the transport network of 5G UDN [125]. Traditional microwave frequency bands are not suitable for this because of the spectrum scarcity. Hence, 5G considers mmWave transport networks (i.e., fronthaul, midhaul and backhaul) to complement optical fiber [121]. In addition to the mmWave access network, the mmWave frequencies will pave the way for

a redesign in backhaul networks [126]. Due to the high bandwidth in mmWave spectrum, capacity will be available with more flexibility and less cost. The deployment flexibility of DU and CU will enable multiple use cases with different requirements in terms of throughput, latency and reliability. Conversely, the propagation characteristics of mmWaves bring new challenges due to high path loss and heavy blockage.

E. MEC with 5G

The UDN deployment in 5G era will address the increased throughput and low latency requirements of the future applications [127]. As the MEC brings the computing and storage capabilities towards the end user [42], [128], [129], UDN and MEC are considered as two distinct but complementary technologies in 5G networks [130]. In contrast to MEC enabled macro base stations, MEC enabled UDN bring clear advantages in terms of latency for computational offloading due to proximity of the server resources. The reduced cell radius of the base stations in UDN leads to a reduction in energy consumption of the end devices and each base station because of the short-range transmissions [127]. As a result, the end device batteries will last long and motivates the design of lightweight devices with small batteries (e.g. wearable devices). The network energy efficiency is a crucial factor for the sustainability of UDN, whereas several studies suggest that UDN is more energy efficient than densification of macrocells [127]. Due to the promising future with 5G UDN, the utilization of MEC with 5G UDN benefits future applications which require excessive computing power. The improved flexibility of 5G core network functions enabled by SDN and NFV allows more distributed user plane resources while maintaining centralized control, benefiting ultra-low latency use cases. The possibility of deploying NF such as UPF in MEC enabled UDN achieves ultra-low latency as the communication is less depending on the backhaul network. The flexibility allows the deployment of MEC and the core NFs at the closest base station to the user, or at a network aggregation point covering several base stations, or even far from the users. The deployment depends on the availability of physical computing resources, business requirements, technical parameters, supported applications and their requirements and measured or estimated user load [131]. Figure 13 shows the integrated deployment of 5G network and MEC proposed by European Telecommunications Standards Institute (ETSI) [131].

F. MAR with 5G and MEC

To serve future MAR, the networks must support extremely high data rates, ultra-low latency as highlighted in III-C, which are beyond the offerings of current 4G networks [132]. Moreover, AR is identified as a service which will play an increasingly significant role in the 2020+ timeframe with 5G vision [133]. AR and VR applications require very fast request-response cycles [134], which will drive the design of 5G network architectures. Due to the strict requirements of ultra-low latency, extremely high bandwidth and massive connectivity of the future MAR, all MAR devices are expected to have direct 5G connectivity without any intermediate

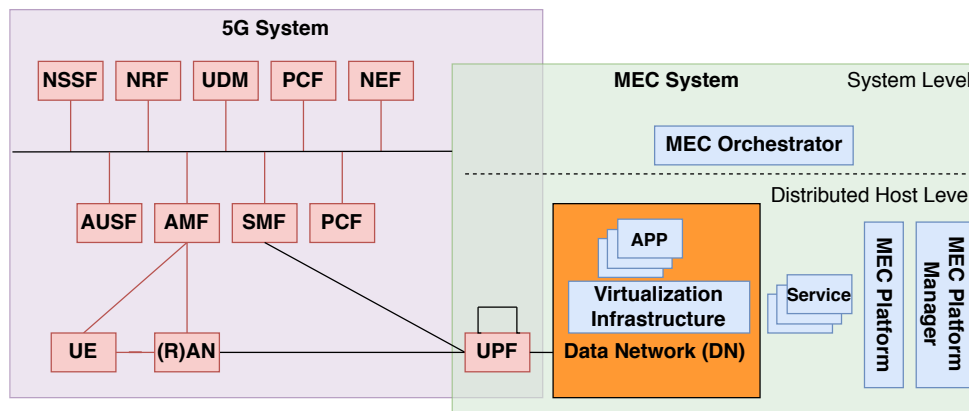

Fig. 13: Integrated MEC Deployment in 5G Network [131].

non-3GPP networks, as illustrated in Figure 11b. The high throughput requirements will be supported by the eMBB service class and the latency requirements will be addressed by the URLLC service class in 5G, both are mandatory to realize MAR. The extensive indoor connectivity provided via UDN with mmWave frequencies, massive MIMO and beamforming technologies, provides a guaranteed data rate in a MAR network. The flexibility provided by the SDN and NFV technologies supports the distributed deployment of the core NFs. This helps to host UPF close to the user to support ultra-low latencies in a geographically distributed MAR networks (e.g multiple factory locations requiring similar kind of maintenance support via MAR).

Since future MAR needs high data rates, ultra-low latency and the possible use of lightweight devices, edge processing at 5G mobile networks likely to guarantee the requirements of MAR applications [135]. For a general AR application, particular environment and the details about the surroundings are highly localized and often irrelevant beyond the point of interest [42]. Few details or a summary of the processed data might be sufficient beyond the MEC server. Hence, MEC processing ensures efficient bandwidth utilization. This concept is illustrated in Figure 14, where the local information is processed at the MEC server deployed at the 5G base station and only the mandatory information is passed to the cloud via the MNO core network.

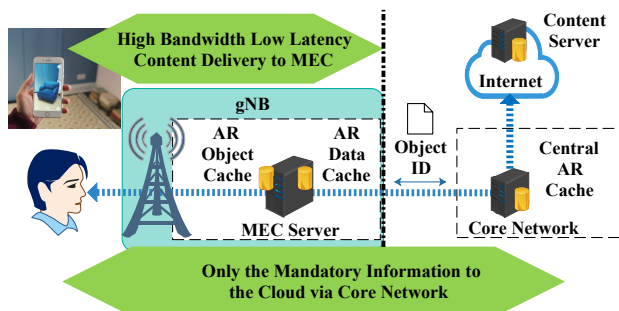

Fig. 14: A Mobile Augmented Reality Service Scenario [42].

In general, MAR users in a given environment tend to seek similar type of data at different times. The captured images may consist of overlapping content. Transfer of redundant data

inefficiently utilizes the network resources, mainly when of-flooding is used. Caching techniques overcome this problem by keeping the popular content at MEC server, which significantly reduces the processing at the MEC server in applications like AR [69], leading to reduced E2E latency. Therefore, MEC architecture with 5G networks will be prominent in satisfying the requirements of future MAR applications.

MAR with MEC enabled UDN poses new challenges. Added communication latency compared to a standalone MAR system is a critical consideration. The deployment of AR server in the closest base station helps to achieve ultra-low latency, but not necessarily the optimal design for a geographically distributed MAR system. The optimal AR server location(s) should be decided based on multiple factors, such as the cell radius, number of MAR users, latency and throughput requirements. Establishment of AR servers at the closest base stations would be costly and add management overhead. Compared to a cloud based deployment, expansions and upgrades must be performed at multiple servers, which is complex and time consuming. A detailed discussion on different technical aspects deciding MAR system design is presented in Section V. The reduced cell radius and the increased base station density cause higher handover frequency than in macro base station deployments [130]. Security and privacy threats are high in MEC based MAR than a standalone, device based MAR.

IV. 5G MEC BASED MAR APPLICATIONS

As 5G and MEC technologies facilitating the expansion of MAR, the practical realisation of MAR in a wide spectrum of use cases will be possible. This paper identifies key application areas for MAR pointed out by multiple sources including past surveys on AR [5], [14], [21], [22], [50]–[53], ETSI AR framework [136], Global System for Mobile Communications Association (GSMA) whitepaper on AR and VR [66], 3GPP technical reports for extended reality in 5G 26.928 [137] and 26.998 [138]. This section briefly discusses potential use cases under common application areas and related scientific work. Moreover, it looks into the future of these use cases and how 5G, MEC and other supportive technologies can develop more sophisticated MAR systems. This section considers application

areas of Industry 4.0, healthcare, travel and tourism, smart city and smart home, automotive, aviation and aerospace, online education and other applications/use cases.

A. Industry 4.0

The key objective of Industry 4.0 is to drive manufacturing forward by being faster, more efficient, and customer-centric [139]. Industry 4.0 interconnects the factory elements while adding them more intelligence, causing improvements in adaptability and resource efficiency [140]. It represents an integration of IoT, analytics, additive manufacturing, robotics, artificial intelligence, advanced materials, and AR [141], [142]. The extreme requirements of Industry 4.0 use cases call for network infrastructure providing high capacity, ultra-low latency and massive connectivity, as envisioned by 5G [140].

1) Use Cases

MAR is expected to play a major role in Industry 4.0 use cases. MAR assisted maintenance [143], [144], MAR based remote maintenance [145], [146], AR remote cooperation [138] allow an unskilled operators to perform the maintenance activities without the experts on site. MAR has great potential for conducting remote training sessions in industrial environments, which essentially uses the same concept as remote maintenance. Guiding and providing monitoring support for assembly tasks [147], [148], improving the safety of factory workers via MAR based instructions [149] makes MAR an essential part of Industry 4.0 operation.

2) Future with 5G

The existing industry based real world implementations of MAR mostly work as standalone entities, whereas Industry 4.0 demands more sophistication. The device information can be shared with another to reduce processing overhead, leading to more efficient operation. MEC enabled small cell base stations could act as the aggregation points for networked intelligence. An advanced communication infrastructure like 5G should be in place to enable such scenarios due to the strict requirement of MAR operation [132]. Moreover, the present implementations mainly use bulky devices which are difficult to use for a long time and consume more power. 5G with MEC enables low power consumption for user devices due to process offloading [130] and low power transmissions [127], allowing the development of more user friendly devices. So far, MAR devices mainly use only the information captured by its own sensors. However, the full integration of MAR with the IoT infrastructure will facilitate the realization of Industry 4.0. With 5G systems allowing the integration of IoT into 5G system [150] and MEC enabled IoT [151], MAR operation can be made more informative and intelligent by utilizing the additional data. Achieving URLLC will be challenging with IoT devices operating under different protocols and require further research. The high density of base stations in 5G UDN allows MAR devices to simultaneously connect to multiple base stations to obtain increased data rate. Massive MIMO and beamforming together help directed data transmissions, ensuring reliability even with mobility. Even though it is possible to bring AR server close to the user with MEC enabled 5G UDN, this could not be the optimal case when remote entities

are involved. Context aware offloading/placement [152] of AR server instance is needed with dynamic remote entities, to ensure optimal MAR operation. A high capacity mmWave backhaul [121] is useful in such scenarios. With the processing functions are offloaded to nearby MEC enabled base stations, 5G allows easily scalable MAR networks.

B. Healthcare

1) Use Cases

AR assisted surgery [91], [153] is a widely discussed topic in the healthcare sector. The scenarios of AR assisted surgery vary based on user location and the way AR is used. Fixed AR screen in the operating theaters to enhance the visualization for surgeons [154], may not utilize any communication service. Conversely, wearable MAR devices in surgeries [155] are far more user friendly. However, they require robust wireless communication infrastructure support for proper operation if they need to offload processing. Obtaining the support of remote entities for surgeries require advanced communication infrastructure such as 5G systems [91]. AccuVein [156] is a localized MAR solution. It uses a projection based AR which consists of laser based scanner, processing system and digital laser projection in a handheld device to visualize a virtual real-time view of underlying veins on top of the skin. AR based medical training [157], AR/VR based rehabilitation [158], MAR based personalized medicine enhanced with eye tracing [159], speech recognition, motion tracking are few other applications of MAR in healthcare.

2) Future with 5G

MAR devices, robotic mechanisms, surrounding sensors and haptic feedback devices to ensure the success of the surgery. A reliable 5G communication infrastructure comprises next generation access, backhaul and core network will satisfy the extreme requirements of these use cases than the existing 4G networks [160]. Medical education is a vital application of AR into the healthcare field, which helps to train healthcare workers, students and educate patients. The COVID-19 situation has urged everyone towards remote education, and the complexity of medical education can be addressed in a better way via AR based solutions [161]. To access the educational content using AR from anywhere, MEC enabled 5G UDN would be ideal for server placement and content caching. The distributed user plane functions deployed at MEC servers will also aid fast streaming of content. The visualization of AR in surgeries can be enhanced with the integration of data from Internet of Medical things (IoMT) [162], providing enhanced perception for the surgeon. MEC enabled IoT [151] would aggregate the knowledge generated by a vast number of surrounding sensors to facilitate such use cases. The world's first remote surgery over 5G [163] demonstrates a surgeon performing a surgery 30 miles away from theatre, paving the way for AR based remote surgery. With 5G ensuring the critical service levels required for remote surgery use cases, integration of IoMT and AR will realize more sophisticated the remote surgery use cases [164], [165], backed by 5G.

C. Travel and Tourism

1) Use Cases

MAR based navigation such as Google Maps [81] improves the view to aid the user in unfamiliar areas. The location specific MAR based indoor and outdoor guidance systems [83]–[86] are helpful for the tourists in places such as parks, museums, libraries, hotels or shopping malls. Augmenting information on top of the view of real objects [166] helps the tourists by providing additional knowledge on museum artifacts, hotel menus and hotel rooms. MAR based translation applications [82] are popular and very helpful for tourists. AR based tour guides [167] navigate the user along the tour while providing important extra information. The present real world implementations of MAR in travel and tourism sector usually involve pointing the mobile device camera to a target marker and obtain more information by means of images, text, audio and video. Examples of such applications are interactive hotel elements, transport [168], restaurants/catering [169] and attractions [170]. The latency requirements of these applications are not critical and the data rate requirements are satisfied by a conventional 4G Internet connection.

2) Future with 5G

Combination of AR and VR, real time XR sharing which allows a user to share his XR experience [137] unlocks considerable potential in the travel and tourism sector and introduces new ways of comprehending the world. Such applications [171] are presently at their infancy, however, could greatly benefit from 5G and MEC. The virtual content can be cached, and the AR servers can be placed at the MEC enabled 5G base stations to minimize the communication latency. MEC architecture enabled with 5G is optimal to serve these applications since the content is highly localized. The present MAR based travel applications [168]–[170] need the user to point and keep holding the device which is uncomfortable and not user friendly. Conversely, future AR will be based on user friendly wearable glasses [28] which are extremely low powered and lightweight. Moreover, the device sensors should operate under diverse environmental conditions which makes the processing algorithms more complex, making computational offloading a must. On the other hand, the user movements will cause reductions and the blockage of signal strength. However, 5G UDN allow users to have strong simultaneous connections to multiple base station [172]. Hence the effect of fading and blockage can be mitigated to provide uninterrupted connectivity.

D. Smart City and Smart Home

1) Use Cases

The use of MAR technology to assist elderly and disabled residents [173], [174] is a prominent use case for future smart homes. The disabled people can control the environment using a handheld mobile device equipped with a MAR application, without physically accessing each device/control switches. The activity could be operating electrical appliances, opening the doors, switching off or dimming the lights. Increasing the accessibility of people having motor disabilities in a smart

city [175] enables the users to interact with items placed beyond their arm's length. Navigation through smart cities using MAR [167] provides visitors with a better experience. MAR enhanced smart building management systems [176], [177] are capable of recognizing building geometry, simulate building visualization, identify assets and incorporate the feedback from the user to enable proper management of the smart building. Applications like IKEA Place [98] equipped with AR, allow users to visualize the furniture placement before making the purchase decision. Integrating MAR for remote monitoring of smart homes [178] has a great potential to make the application more user friendly and sophisticated.

2) Future with 5G

The successful implementation of smart cities highly depends on 5G systems [179]. Smart cities and smart homes enormously rely on IoT, whereas 5G is envisioned as a great IoT enabler [180]. The present MAR applications can leap forward with the 5G and IoT enabling smart cities and smart homes. For smart homes, security monitoring enabled with AR can alert suspicious behaviours and current warnings on property owner's remote mobile screen. These warnings can be enhanced with the details of suspicious individuals if they have criminal records. The smart home connectivity can be provided with MEC enabled 5G where the AR server is located at MEC. Other future scenarios would be to highlight malfunctioning electrical equipment, high temperature areas, accidentally left open doors, which would essentially require the inputs from multiple sensors to be integrated with the AR system. Existing applications like Smart AR Home [181] support only a set of smart devices by specific manufacturers. Developing applications supporting any device would be a future requirement for high AR penetration. Otherwise, it will be inconvenient to use multiple applications for each device. Integration of 5G and IoT [150] will allow the coexistence of heterogeneous IoT devices facilitating these use cases. The design/renovation of homes/buildings/cities could benefit from future MAR where the virtual representation of planned design could be merged with the present real view to visualize the completed design [98], [182]. Caching content at the MEC enabled 5G UDN [183] and MEC based AR processing is suitable in these use cases as the content is highly localized.

E. Automotive

1) Use Cases

AR-enhanced windshield [89], [90], projects vital information into the windshield such as navigation information, current speed, present speed limit and the best possible driving path. It aims to reduce the distractions and helps the driver to stay focused on the road. The projection to HMDs [184] serves the same purpose of providing additional information for the drivers. The "see-through" view [185] allows a driver to see the road as if there is no front vehicle blocking the road. Coordinated communication among vehicles and AR together generates an augmented view by artificially removing the front vehicle's obstructing view. AR-enhanced driver training [186] with the help of synchronized HMDs allow the trainers to simulate the emergency events during training, making the

drivers more experienced before they drive on public roads. Automotive industry utilizes AR as a comparison tool [187] to compare the real parts against the design to identify defects. Modern vehicles now identify the road signs and project them on to appropriate place on the front road to alert drivers [188].

2) *Future with 5G*

The current AR processing occurs inside an automobile, but the vital information is hardly shared outside. Conversely, vehicular communication is an extensively discussed topic with 5G systems [189] which delivers wireless connectivity among vehicles, roadside devices, passengers, and pedestrians. With 5G, vehicular MAR systems can benefit from the information shared by other vehicles for facilitating the drivers to make the roads safer. Data sharing solutions proposed by geographically distributed cloudlets [190] to exchange data among vehicles can be implemented with 5G UDN and MEC. The communication demands of “see-through” view can only be realizable with 5G. A potential future use case that needs improvement is the real time text-based traffic sign detection [191] while the vehicle is moving. Text based traffic signs written in other languages are impossible to read instantly, whereas modern OCR, translation and AR systems in combination can provide a solution. The future connected vehicular systems with 5G can reduce the processing burden by allowing the vehicles to augment the text based traffic signs with driver’s preferred language, using the already translated content from cloud/MEC servers and the vehicle GPS data. Similar concepts can be applied in the future to enhance the capabilities of AR based driver training applications [192] where the trainee driver is supported with augmentations received via the vehicular network connected with 5G.

F. *Aviation and Aerospace*

1) *Use Cases*

AR technology is often used in aircraft pilot training [88] where trainee pilots get familiar with the real environment before they get into the aircraft, reducing the potential risk of accidents. Fighter pilots use helmets equipped with AR technology to view vital information as they maneuver the aircraft. Currently, these features are gradually adapting to commercial aircraft too. A unique place where AR is often used for maintenance activities is the space station [193]. Ground test and maintenance process guidance of aircrafts [194], AR assisted aircraft maintenance training and operations support [195], MAR at airports [196] are other examples from the aviation industry.

2) *Future with 5G*

The aviation and aerospace AR applications such as pilot training, augmented views at the cockpit mostly operate as standalone applications and may continue with the improvements inside the systems. Unlike other application areas, the networked intelligence or the collaboration of AR applications is challenging to achieve while the aircraft is flying. However, there is vast potential for improvements in AR usage while the aircraft is manoeuvring at the airports. By integrating the air traffic control information, the flight guidance towards the runaway can be enhanced with AR [197]. The landing and

takeoff can be enhanced with the most appropriate path during extreme weather conditions to minimize accidents. With the integrated information about the other flights, the pilots can be alerted about potential dangers via the HMDs. Passenger maneuvering through airports can be enhanced by feeding information from different sources so that the passengers will be guided using MAR via the most optimized route to the exits/connecting flights [196]. These use cases require reliable indoor network connectivity provided by 5G UDN. Use of HoloLens for the cabin crew [198] to display passenger information can be combined with other information sources such as travellers history data, present airport congestion data to serve the passengers in a better way. 5G communication infrastructure deployed at the airports will play a vital part in these applications by creating a reliable and ultra-low latency communication infrastructure.

G. *Online Education*

1) *Use Cases*

Online education platforms allow the students to continue their education without interruptions during the COVID-19 pandemic [199]. These platforms allow potential real-time interaction between the students and the teacher using high-quality videos to replicate the classroom experience and may continue in the post-pandemic era. MAR has excellent potential in such educational activities [200]. AR and VR based distance learning solutions [201] provide students with self-learning opportunities. Online examination platforms introduced by educational institutions support the students for timely completion of their examinations. Examination monitoring can be enhanced with MAR via a high-quality video stream, provide clarifications and instructions, and answer the students’ questions during the exams to make sure that they follow the guidelines similar to the approach of one to many AR conferencing [138].

2) *Future with 5G*

5G provides better indoor connectivity with small cell gNB using mmWave frequencies, ensuring connectivity anytime anywhere. Real time online teaching needs low latency HD/4K video streaming where 5G URLLC and eMBB services are capable of offering [202]. Caching MAR based educational content at 5G MEC servers enables streaming the contents with low latency as the similar content is likely to be streamed by many students in a given area. MEC based deployment of AR server function is a potential deployment option also support low latency service provision. SDN and NFV help fast and dynamic deployment of such content at the MEC servers based on the demand in a given area.

H. *Other Applications and Use Cases*

Other potential MAR application areas include entertainment [203], gaming [31], [137], safety [204], retail [205] and advertising [206]. The use cases highlighted in 3GPP technical reports for extended reality in 5G [137], [138] such as AR sharing, streaming of immersive 6DoF, AR remote corporation, real-time 3D communication, extended reality (XR) meeting and emotional streaming could be used in multiple

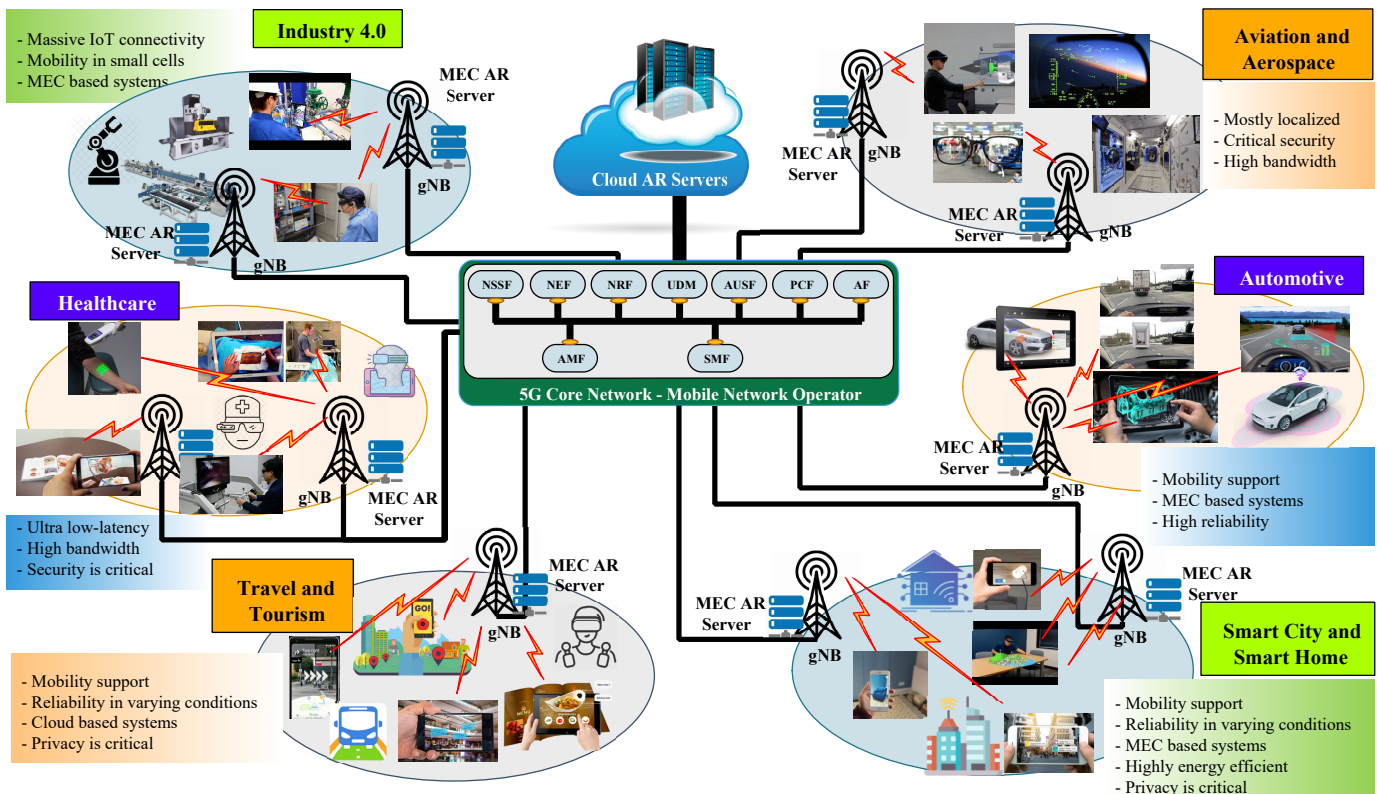

Fig. 15: Different 5G MEC based MAR Applications.

application areas. For example, AR remote corporation could be used in Industry 4.0 to conduct a multi-party maintenance task and also in healthcare for a collaborative remote surgery. Key properties of use cases under each application area are outlined in Table V, especially considering the communication aspects. Figure 15 provides a visual representation of the key the applications discussed in this paper.

V. TECHNICAL ASPECTS OF MAR IMPLEMENTATION WITH 5G MEC

This section discusses different technical aspects, which play an essential role in realizing future MAR systems. Communication, mobility management, energy management, service offloading, service migration, security and privacy are discussed and analyzed. The paper briefly introduces each technical aspect, describes the requirements and limitations of each in relation to MAR, and presents how 5G features and the related technologies help realize the requirements by mitigating the limitations. The comparative importance of each technical aspect for the use cases is presented in Table VI.

A. Communication

MAR is the application of AR that users can take with them wherever they go [27]. Instead of carrying a dedicated device for MAR, users would prefer the service on general mobile devices or lightweight devices like wearable glasses. Both wearable devices and general mobile devices need process offloading to preserve their limited battery life [210]. Network connectivity is a must for future MAR applications

to provide users with the envisaged benefits. Cloud based MAR applications like AR enhanced Google Maps [81] needs an Internet connection to operate. Extreme MAR use cases like AR assisted surgery [91] are not fully realizable with the present 4G networks and require more sophisticated next generation wireless systems. Hence, wireless communication plays a vital role to realize future MAR.

1) Limitations/Requirements of MAR

Limitations of the present 4G networks prevent the realization of emerging MAR applications, as discussed in Section III-C. The communication requirements, such as ultra-low latency and high throughput, arise from the applications. A study in communication for automation in vertical domains [94] reveals that the E2E latency between capturing a new image and the displaying the augmented image should be smaller than 50 ms to avoid cyber-sickness with one-way E2E latency of the communication system within 10 ms. The 10 ms includes the aggregated latencies of access and backhaul networks. The communication latency, expected data capacity and service availability requirements are depicted in Table V for key use cases under the application areas. The required data rate depends on factors like the resolution of the video and the frame rate. For general industrial applications, video streams with a frame rate greater than 60 Hz and 1280 x 720 High Definition (HD) resolution are desirable [94]. It is also required that the video stream between the MAR device and the image processing server should be encrypted and authenticated.

TABLE V: Properties of Key MAR Applications

Application	Scalability	Expected Latency	E2E	Expected Data Capacity	Other Requirements	Possible Implementations/Examples
Industry 4.0						
MAR based remote assistance with uncompressed 4K (1920 x 1080 pixels) 120 fps HDR 10-bit real-time video stream [91], [94]	> 3 AR devices per base station	<10 ms		> 7.5 Gbps	Mobility support up to 10km/h User Equipment (UE) speed. Service availability >99.9%	Assisting maintenance technicians, Industry 4.0 remote maintenance, remote maintenance in robotics industry [143]–[146]
Assembly line monitoring with HD (1280 x 720) video streaming [94]	> 3 AR devices per base station	<10 ms		> 3.5 Gbps	Service availability >99.9%	AR based assembly systems [147]
Healthcare						
MAR based specialist/surgeons' training [91]	1-100 devices	<20 ms		> 2 Gbps	Communication service availability >99.999%	ImmersiveTouch Platform [207]
AR based remote surgery with uncompressed 4K (3840x2160 pixels) 120 fps HDR 10-bit real-time video stream [91]	1-100 devices (Including environmental sensors)	<750 μ s		> 30 Gbps	Communication service availability >99.99999%	World's first remote surgery over 5G [163]
Travel and Tourism						
Cloud based MAR applications [92]	Practically unlimited (globally)	<50 ms		50-100 Mbps	Mobility support at higher UE speeds	Google Live View [81], AR enhanced Google Translate [82]
Indoor and localized outdoor navigation [92], [94]	1-100 simultaneous devices	<20 ms		50-200 Mbps	Mobility support upto 10km/h UE speed	Theme parks, shopping malls, archaeological sites and museum guidance [83]–[86], [166]
Smart City and Smart Home						
Assisting elders at smart homes [174]	1-10 devices per home	<20 ms		50-200 Mbps	less complex and user friendly	Augmented Reality Control Home (ARCH) [173]
Building management and interior decorating applications [98], [176], [177]	1-100 devices	<50 ms		50-200 Mbps	Service availability >99.9%	IKEA Place [98]
Automotive						
AR based driver training [186]	1-3 devices	<20 ms		> 2 Gbps	Communication service availability >99.9%	AR DriveSim [192]
“See-through” front vehicle with uncompressed 4K (1920 x 1080 pixels) 120 fps HDR 10-bit real-time video stream [66]	2 devices	<5 ms		> 7.5 Gbps	Mobility support with higher UE speed. Service availability >99.999%	Multi-vehicle cooperative perception [185]
Aviation and Aerospace						
Pilot training (Flights) [88]	1-3 devices	< 20 ms		> 2 Gbps	Communication service availability >99.9%	Blue Boxer Extended Reality (BBXR) Training System [208]
Pilot training (Drones) with uncompressed 4K (1920 x 1080 pixels) 120 fps HDR 10-bit real-time video stream [94]	2 devices	< 10 ms		> 7.5 Gbps	Communication service availability >99.9%	DronOSS - AR based drone pilot training [209]
MAR assisted aircraft maintenance with HD (1280 x 720) video streaming [94]	> 3 AR devices per base station	<10 ms		> 3.5 Gbps	Service availability >99.9%	AR for aircraft maintenance training [195]
Online Education						
MAR based streaming of educational content [201]	Practically unlimited (globally)	< 10 ms		> 4 Gbps	Communication service availability >99.9%	Augmented/virtual laboratory tests for students [201]
MAR based online teaching [202]	Practically unlimited (globally)	< 10 ms		> 4 Gbps	Communication service availability >99.9%	Collaborative virtual class with multiple students [201]

2) How 5G Helps

Exploiting the mmWave spectrum in 5G has the potential to reach much higher bandwidths, bringing a solution for the high throughput requirements of MAR applications [211]. Deployment of UDN will mostly provide directional links between MAR users and the base stations causing more reliability. Massive MIMO and beamforming technologies increase the data rates because the transmission and the reception occur via multiple antennas, and the beams are directed. A gNB with three cell sites can handle up to average 10 Gbps in 5G when equipped with multiple antennas for transmission and reception [123]. Fundamental design changes of the 5G systems will enable critical services (ultra-low latency). Solutions such as short symbol periods, flexible Transmission Time Intervals (TTI), low power digital beamforming for control [212] has been proposed to deliver ultra-low latencies at the Medium Access Control (MAC) layer. The achievable one-way latency between the UE and the CU is 4 ms for eMBB and 0.5 ms for URLLC [123]. The flexibility of the 5G core network enabled by NFV and SDN allows pushing the core network functions to the MEC, facilitating low latency communications. The modular design of the transport network is capable of service-oriented placement of DU and CU functions [213], preferably closer to the user at the gNB. MEC enabled UDN allow the deployment of powerful AR servers closer to users benefiting the MEC based and hybrid MAR architectures. The combination of the above factors ultimately addresses the present communication limitations and enable the design of better MAR systems in the future.

B. Mobility Management

AR devices have significantly evolved to powerful and easy to use devices such as wearable MAR glasses from the first prototypes that supported portability, where the users had to carry backpacks equipped with computing devices. With the exponential growth of user mobility and the envisioned future MAR applications, the true potential of MAR can be realized with devices directly connected to 5G networks [94]. Mobility support of the network ensures the service continuity as the user moves. However, the high throughput and ultra-low latency requirements of MAR applications make mobility support even more challenging. Since the 5G networks are primarily built with small cell UDN, the frequency of handovers will be higher. Since the mmWave propagation is highly susceptible to fading and blockage, the channel quality on a mmWave link can be extremely intermittent. Mobility support is mandatory in MAR to provide a seamless user experience. MAR applications will be used in diverse localities with varying environmental characteristics making mobility support even more challenging.

1) Limitations/Requirements in MAR

The 5G system supporting MAR communication should provide seamless mobility so that a handover from one base station to another base station does not have any noticeable impact on the application [94], [214]. The LTE requirement for handover execution is 49.5 ms [214] is suitable for mobile broadband and voice applications. However, it is not even

nearly sufficient for latency critical MAR applications like automotive applications, remote surgery [163]. Therefore, the main requirement to achieve seamless mobility is to minimize handover time. Moreover, the horizontal indoor positioning accuracy should be better than 1 m with 99% availability for a moving MAR device with speed up to 10 km/h [94].

2) How 5G Helps

Make-before-break, where the UE connects to the target cell before disconnecting from the serving cell is a general solution to minimize handover time. 5G UDN allow multi-cell connectivity [214] due to the availability of multiple base stations in the vicinity. Multi-cell connectivity allows MAR devices to maintain multiple connections with different base stations simultaneously. Despite the added complexity, the session continuity enabled by multi-cell connectivity significantly helps with user mobility. With the flexibility introduced in 5G to deploy the control plane functions closer to the gNB, the use of a local coordinator is possible to perform path switching tasks [215]. The use of local coordinator significantly decreases the path switching time compared with the 4G systems, where the centralized Mobility Management Entity (MME) and Serving Gateway (S-GW) perform the control and user plane functions. The design changes introduced by New Radio (NR) such as INACTIVE state between CONNECTED and IDLE states reduces the time to bring the UE into the CONNECTED state while reducing the signaling overheads and improving the UE battery life [216], which is helpful for MAR with user mobility.

C. Energy Management

To enable new user experiences with MAR devices, they should be equipped with more sensors, powerful embedded cameras, and increased processing power [217]. The energy consumption of a mobile device depends on multiple factors, including display size, the amount of uplink and downlink data traffic, and the power consumption profile of the internal components [218]. MAR requires complex processing which quickly consumes the battery power of the devices. Conversely, the users prefer more lightweight, easy to use devices with less frequent charging. These contrasting requirements pose the challenge of energy management of MAR devices.

1) Limitations/Requirements in MAR

One approach to address the challenge of optimizing the power consumption is the in-device optimization [219] which requires novel hardware architectures and efficient algorithms like Dynamic Voltage and Frequency Scaling (DVFS) technology. The second approach is to offload the computations to an external entity [220], which is the aspect this paper focuses. Offloading helps to reduce the device form factor as the hardware and the battery size can be reduced. The mmWave based devices use massive MIMO to achieve high throughput, which increases the power consumption [221] and imposes a limitation on the use of massive MIMO. The power characteristics of 4G LTE networks [222] show that the devices need more power for high throughput transmissions, which is the case for with MAR with offloading. The cell edge users of 4G macro base stations need more transmit power due to

the increased distance to the base station, is not favorable for an application like MAR.

2) *How 5G Helps*

Edge offloading is generally considered as a suitable approach to achieve energy efficiency of the user devices [223], [224]. Compared to 4G networks, 5G deployment will primarily be with small cell UDN; hence the user devices are near the base stations. This helps to reduce the power required for communication due to low power transmissions [127]. This is particularly suitable for terminals such as wearable MAR devices which require higher throughput but possess limited battery power. A high-efficiency multi-functional mmWave 5G beamforming antenna system is proposed to achieve energy efficiency of 5G user devices [221]. This solution aims to address the increase in power consumption due to the increased number of antennas in future mmWave based high throughput devices.

D. Service Offloading

The core AR processing is computationally demanding, and it is implausible to be executed in the resource constrained MAR devices. This challenge is addressed by computational offloading to a server which has sufficient computing power. The MAR device only executes mandatory processing and finally displays the augmentations received from the AR server. With the advancement of wireless communication infrastructures, application development is more focused on cloud and edge based MAR applications to benefit from the excessive computing power available at the servers. By minimizing the processing at the device level, MAR devices can be made lightweight, energy efficient, user friendly and less expensive.

1) *Limitations/Requirements in MAR*

The costs of computational offloading are primarily latency and bandwidth. For latency critical MAR applications, the E2E latency requirement [94] must be satisfied during offloading, irrespective of the network or the remote server conditions. The links must have sufficient bandwidth to accommodate the data rate required by the applications. A study on offloading via WiFi and LTE to several potential offloading devices [225] reveals that the latency of LTE is noticeable over a strong WiFi connection. A noticeable latency is not a suitable condition for the proper functionality of MAR. The application privacy and security requirements should also be satisfied during service offloading.

2) *How 5G Helps*

A possible solution proposed to minimize the latency in offloading is the exploitation of multiple available links and offload via multiple links simultaneously using a scheduling algorithm [225]. Multi-connectivity in 5G mmWave cellular networks [226] and coordinated multi-point transmission [227] are proposed solutions to increase the robustness, performance and service quality of the link. Due to the proximity of base stations in 5G UDN, simultaneous offloading with multiple connectivity is a viable solution in 5G than 4G LTE. The low-latency requirement of MAR is feasible when the destination server is close to the terminal devices while the multi-point transmission ensures high throughput. Task offloading of UDN

in the vicinity of macro base stations [130] and hybrid offloading framework to offload computations to macro base stations and close by servers [228], exploit the idea of the availability of multiple simultaneous servers for task offloading. Due to the proximity of base stations in 5G UDN, the effectiveness, energy efficiency and the sum rate of computational offloading can be increased to benefit MAR applications.

E. Service Migration

Service migration is the process of moving a service from one place to another, which is beneficial for MAR systems having edge based, cloud based and hybrid architectures. While the main factor for the service migration in MAR being the user mobility, the need for load balancing of the servers, varying channel conditions, changes in MAR application operation can also be the causes for service migration. Other than mitigating the interruptions of ongoing services, service migration helps to avoid the performance degradation, thus improving the Quality-of-Service (QoS) [229].

1) *Limitations/requirements in MAR*

Maintaining the consistent flow in service migration [230] is a mandatory requirement for MAR users as the application requires low-latency and high throughput, especially with user mobility. The services should be available without a perceivable delay to the user. The MAR application dynamics may change during the session with new users, especially from remote locations. Due to the high throughput requirement, this will place a considerable load on the servers, and the service migration algorithms should respond to such user dynamics [231]. Remote server based MAR applications need the service migrations to be stateful due to the interactive nature of the applications [232] to avoid interruptions. Moreover, adequate security and privacy protection is a must to ensure the reliability of service migration as MAR applications require strict service levels and possess sensitive personal data.

2) *How 5G Helps*

The MEC enabled 5G UDN establishes both radio and computing resources in the vicinity of end users. The Follow Me edge-Cloud (FMeC) concept [233] leverages the properties of this architecture to guarantee that the users are always connected with the nearest service. Since the services are delivered from the closest server and the servers are located close by in a dense network, live service migration [232] in a 5G MEC ensures ultra-low latency while the users are moving. With 5G UDN, the MAR devices are operated in the vicinity of multiple base stations, multi connectivity [172] with MEC servers is possible with high throughput channels. The mobility aware dynamic service placement mechanisms [234] can cooperate with multiple servers and optimize communication delay and computing delay to minimize the user-perceived latency. 5G equipped with SDN enable easy customization of security and privacy mechanisms based on the application needs, ensuring the reliability during service migrations.

F. Security

Security is an essential component for a MAR system, ensuring the required service levels (e.g., ultra-low latency) of

the application are delivered. The undesirable outcomes due to unauthorized access, data modifications and data unavailability can be avoided by implementing proper security mechanisms in MAR [235]. Attacks like overload attacks [236] slow down MAR applications in a way that the required ultra-low latency requirements cannot be fulfilled. For example, sensory overload attacks such as playing loud sounds and flashing bright lights on the display, may cause malfunctions in the system. In MAR context, cross-app sharing is a threat where one application shares the sensor data to another unauthorized application of the MAR device. Clickjacking is another type of attack that tricks users into clicking on sensitive user interface elements that are originated from malicious applications [236]. Deception attacks on AR populate the screen with distracting content such as a modified road sign [237]. Therefore, implementing proper security mechanisms during the design and development of future 5G MAR systems is mandatory.

1) *Limitations/requirements in MAR*

Literature categorizes the security of MAR systems broadly into three domains called input security, data access security and output security [236] while few discussing the area of device security [238]. Input security focuses on the security of the data gathered from the MAR device input sensors. For example, the camera may capture the content of personal letters, emails and call logs, and those should not be shared to unwanted parties. Input protection ensures that sensitive information from the data stream is removed before processing. The collected data via different sensors are stored in a database waiting to be processed. Single or multiple AR applications use these data, process them to deliver a consumable output. The users of MAR devices no longer have control over the collected and stored data. Security aspects related to data collection and aggregation, data processing, and data storage falls under the data access security [238]. An unauthorized application accessing the stored data for unwanted purpose is a data access security breach; hence protection mechanisms need to be placed. MAR applications transfer the processed data as augmentations via the output data stream. Malicious parties/applications can gain access and modify the output stream. The modified outputs may display unintended and harmful content and may also make the output stream unreliable. For example, a MAR application that guides a technician through an assembly process might display incorrect instructions or the correct instructions in an incorrect order, making the assembly process unsuccessful.

The input protection should happen closer to the MAR devices, preferably within MAR devices. Then the sensitive information will not be transferred outside the devices. In-device protection mechanisms can be implemented for any MAR architecture discussed in Section II. As the future MAR systems will comprise lightweight wearable devices, in-device security adds a processing burden on every device. Data access related security controls should preferably be implemented at the AR servers. Due to strict application requirements and the multiple possible architectures for future MAR systems, complex edge based security implementations will be required. Even with highly secured cloud AR servers, implementation of security controls at the device, edge and the cloud is a must

because the sensitive data is transferred via the network.

2) *How 5G Helps*

Since 5G network slicing enables independent end-to-end (E2E) logical networks, the guaranteed extreme requirements can be catered via slice based service provision for MAR. With a slice based service provision, the security model for MAR slices can be adapted based on MAR security requirements. Slice isolation in 5G to mitigate DDoS attacks [239] is a potential technique to enhance the security of MAR systems. With the MEC enabled 5G UDN, the complex security algorithms can be offloaded to the network edge, providing Security as a Service (SECaaS) [240]. For example, input security mechanisms for MAR can be implemented at the MEC instead of executing on each device. Enabled by SDN and NFV technologies, the future programmable networks will be centrally controlled, thereby enabling the network-wide consistent security policies for highly reactive and proactive security monitoring [241]. The complex 5G MAR architectures complimented by MEC and cloud requires global and sophisticated security implementations for data access security to guarantee the critical service levels.

G. *Privacy*

The privacy concerns of AR technology are mainly twofold, user privacy [242] and the bystander privacy [236]. The user's privacy concern is that the AR system captures and stores information on what the user sees and then the system knows information about user actions. Bystander privacy concerns are for the people in the environment who get captured into the AR system, even without their knowledge. Hence, privacy protection is vital in AR systems and necessary protections must be imposed, ensuring confidentiality, anonymity, undetectability, unlinkability [238].

1) *Limitations/requirements in MAR*

Similar to security, input privacy protection, data protection and output protection are considered as the elements of privacy in MAR. Input privacy protection aims to protect the inputs to the MAR system for example, the images of the bystanders' faces. If the data is shared with unwanted parties, bystander privacy is compromised. The data protection privacy further divided into three primary data protection layers called aggregation, processing, and storage [238]. Linkability, detectability, and identifiability are few data protection related privacy threats. Encryption based techniques, protected data storage solutions such as Personal Data Stores (PDS) with managed application access permission control, are proposed as privacy protection solutions. Privacy-preserving rendering determines the output display type and applies rules during the rendering to ensure privacy protection. Controlled rendering to restrict disclosing the private information is suitable for public AR output screens. Content hiding methods and visual cryptography protects the output from external interference [238]. The level of privacy protection differs based on the MAR architecture and application requirements. Available device processing power limits the complexity of the on-device privacy protection algorithms.

TABLE VI: Pertinent Technical Aspects on Application Use Cases and their Comparative Importance

Application	Use Case	Technical Aspects						
		Communication (low latency, high data-rate)	Mobility Management	Energy Management	Service Offloading	Service Migration	Security	Privacy
Industry 4.0	MAR assisted maintenance (no remote support) [246]	M	M	H	M	M	M	M
	MAR based remote assistance [143]–[146]	H	M	H	M	M	H	M
	Improving safety of operations with MAR [149]	H	M	H	M	M	H	M
Healthcare	AR assisted surgery with fixed standalone AR devices [154]	L	L	L	L	L	M	M
	Surgeries with wearable MAR	H	M	H	H	M	M	M
	AR based remote surgery	H	M	H	H	M	H	M
	Personalized medication [159]	M	M	H	H	M	H	H
Travel and Tourism	Google Live View [81]	H	H	H	M	H	M	H
	AR enhanced Google Translate [82]	H	M	H	M	M	M	M
	Indoor and localized outdoor navigation [83]–[86], [166]	H	H	H	M	H	M	H
	Fixed AR screens at museums	L	L	L	L	L	M	L
Smart City and Home	Assisting elders at smart homes [173], [174]	M	L	H	L	L	M	H
	Increased accessibility for disabled people at smart cities [175]	H	H	H	M	H	M	H
	Building management/interior decorating applications [98], [176], [177]	M	M	M	M	M	M	L
Automotive	AR based driver training [186]	M	M	L	L	L	M	M
	“See-through” front vehicle [185]	H	H	L	L	H	H	M
	AR as a part comparison tool [187]	M	M	H	M	M	M	M
	AR enhanced windshield [90], [184], [247]	H	H	L	L	H	H	L
Aviation and Aerospace	Pilot training (standalone) [88]	L	L	L	L	L	M	M
	MAR assisted aircraft maintenance [195]	M	M	H	M	M	M	L
Online Education	MAR based streaming of educational content [201]	H	M	H	M	M	L	L
	MAR based online teaching [201]	H	L	H	M	M	L	L

 Low Importance

 Medium Importance

 High Importance

2) How 5G Helps

Like the security protection in 5G MAR networks, input privacy protection can be implemented at the device level or the MEC due to the MEC server proximity to the user. The hybrid 5G MAR architectures allow the deployment of MEC AR servers at the closest gNB, allowing privacy protection closer to the user to protect the sensitive data similar to the hybrid privacy protection approach proposed in [243]. Privacy protection can be enabled in 5G networks using network slicing technology via isolation. The input, data protection and output privacy protection can be enabled flexibly through a MAR slice or even with different MAR slices for applications with different privacy requirements. The use of SDN in 5G networks will allow privacy-aware routing mechanisms [244], which can be used to forward sensitive data only on the trusted routes benefiting cloud and hybrid MAR applications. As the 5G UDN will have base stations with reduced cell radius, the privacy of MAR users with high mobility can be protected via mechanisms such as privacy-aware SDN-based authentication handover schemes [245].

VI. LESSONS LEARNED AND FUTURE WORKS

In this section, the paper discusses the lessons learned, the remaining research problems, related preliminary solutions and future research directions for the technical aspects discussed in Section V. The focus of the discussion is how the research problems for 5G MAR can be addressed by improving the existing preliminary solutions and by novel approaches. Finally, remaining challenges and open issues are discussed mainly focusing on the deployment aspects. A summary of future research directions for 5G MAR is depicted in Figure 16.

A. Communication

1) Lessons Learned

The novel technologies introduced with 5G such as mmWave, small cell UDN, massive MIMO and beamforming together forms a communication infrastructure that satisfies the high throughput demand of future MAR applications. The design changes are proposed in symbol periods and transmission time intervals to achieve ultra-low latencies. MEC enabled 5G brings the computational capabilities more towards the user, further reducing transport delay. Using SDN and NFV capabilities, the network functions can be pushed to the MEC servers enabling more decentralized architectures to benefit

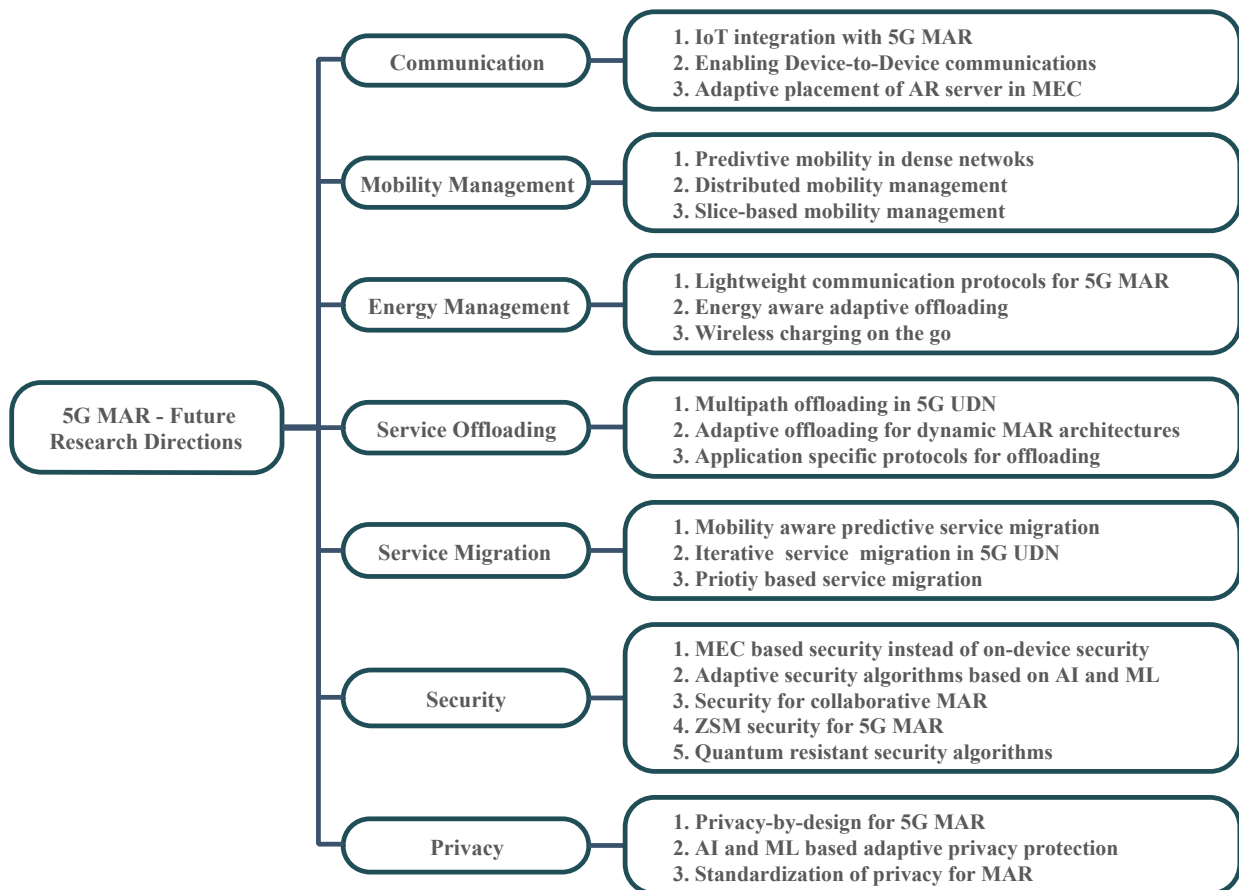

Fig. 16: Future Research Directions for 5G MAR.

MAR application demands. Substantial enhancements can be made by integrating IoT with MAR, guiding towards more complex and sophisticated MAR applications.

2) Research Problems

- How to integrate MAR with IoT, given that the IoT devices communicate with different protocols and do not guarantee critical service levels?
- How to respond to sudden changes in application demands? How to decide the optimum placement of AR server function instances in a case where users are geographically distributed?
- Collaboration between devices may be used to avoid redundant processing. How to enable collaborative communication between devices?
- Environmental conditions heavily impact mmWave propagation. This causes a comparably higher impact on outdoor use cases. What solutions could be proposed to ensure uniform network access for MAR devices in varying environmental conditions?

3) Preliminary Solutions

Recent research efforts [248] highlight how perception can be enhanced with IoT and MAR integration, and ultimately lead to reduced complexity for users and increased operational efficiency. Joint server assignment and resource management for edge-based MAR system [249] propose a scheduling algorithm for multi-user MAR with dependant tasks. Intelligent application placement between edge and cloud [250] proposes

a more efficient MEC-AR framework. Both these efforts lead to minimizing overall latency and pave the way towards adaptive MAR systems.

4) Future Research Directions

Immediate transmission of ultra-low latency data among the eMBB data is proposed to achieve URLLC. However, MAR traffic exhibits the properties of both eMBB and URLLC. Novel solutions should be proposed in this regard to support applications with extreme demands. Considerable research efforts are needed in applications layer protocols such as advance video coding mechanisms on high resolution video to save the bandwidth. Adaptive placement of AR server to yield dynamic architectures based on application changes similar to the one proposed for 5G network functions [251], is a possible research area concerning MAR.

B. Mobility Management

1) Lessons Learned

The potential growth of MAR application domain facilitated by 5G services require the mobility support mandatory with the critical service levels. In addition to the applications hosted in general mobile devices, wearable MAR devices are also expected to connect with 5G directly. Unlike the MAR applications hosted in general mobile devices, wearable devices could be application specific with optimized hardware and software. As 5G small cells have reduced cell radius,

handover frequency will be high and proper mobility support will be a crucial design consideration for future MAR systems.

2) *Research Problems*

- How to enable critical service levels (e.g., ultra-low latency and high data rate) for MAR applications with mobility support? What novel design changes in handover procedures are needed?
- What novel solutions are available to support mobility at high speeds such as MAR systems in connected vehicles?

3) *Preliminary Solutions*

Distributed mobility management for future 5G networks [252], exploiting the multi-cell connectivity to support mobility [215], SDN based mobility management techniques [253] are some of the solutions for 5G UDN to achieve fast handovers and ensure service continuity.

4) *Future Directives*

Despite the importance of mobility support for future MAR, comparably little research has been done concerning mobility in 5G MAR. Achieving the critical service levels itself is challenging, and mobility adds further complexity. In a MEC enabled 5G UDN, caching techniques can be employed to support seamless mobility. Content caching at multiple nearby MEC servers and executing proper service migration techniques will support service continuity during mobility. Mobility prediction via Artificial Intelligence (AI) and machine Learning (ML), slice based mobility management where the mobility function is handled by a dedicated optimized network slice, are also possible future research directions.

C. *Energy Management*

1) *Lessons Learned*

As the Wearable MAR device penetration is expected to increase in 5G era, energy efficiency will become a critical consideration for effective utilization of the devices. Larger batteries will compromise the form factor and the user friendliness of the devices whereas lightweight devices with small batteries may need frequent recharging. In device optimization of computing resources and processes (i.e., introducing novel hardware techniques, complex algorithms to manage processes) and computational offloading are the two major solutions to reduce MAR device energy consumption. Design of application-specific hardware like AR glasses instead of executing applications in general mobile devices could also be a solution for specific MAR uses (e.g., surgeries in the healthcare domain).

2) *Research Problems*

- How to design algorithms to find the optimum balance between computation and communication processes, since both processes consume MAR device energy? What level of in-device processing and what level of offloading achieves the maximum energy efficiency?
- Video coding is mandatory to ensure efficient bandwidth utilization. What energy efficient coding techniques should be used in each application to achieve energy efficiency?

3) *Preliminary Solutions*

Dynamic offloading and resource scheduling policies consider the present computing workload, estimated completion time and current transmission power of the mobile device [223] to achieve energy efficiency. These context-aware algorithms can be applied in 5G MAR to achieve device energy efficiency. Algorithms which consider the transmit power before computational offloading [254] can also be applied in 5G UDN based MEC environment due to the availability of multiple MEC servers in the vicinity.

4) *Future Directives*

The usage and the operating environment is specific in applications like industrial and healthcare domain MAR systems. Low power, application-specific hardware and software designs can be employed to reduce the energy consumption in such use cases. Substantial research work is needed in designing such devices as they are expected to establish direct connectivity with 5G. Improvements can be made to the approaches proposed in [223], [254] by utilizing AI and ML techniques. They can be made adaptive based on network changes such as channel conditions and user mobility. Design of novel application-specific lightweight communication protocols for future 5G MAR to minimize energy consumption is a potential research topic. Exploiting the potential for wireless charging on the go [255] into MAR systems will be a paradigm shift in solving the problem of limited energy.

D. *Service Offloading*

1) *Lessons Learned*

Future MAR requires the processing of a vast amount of data within strict service levels, while the user preference is to receive the services via lightweight and wearable devices. The computing power of such devices will not be adequate to perform all the processing within the device, creating the need for computational offloading. It is seen that very few specific applications (e.g., MAR in a military aircraft) do not require computational offloading. However, cloud/MEC offloading is a promising approach by the research community for many MAR applications. Specific applications (e.g., MAR based military applications) may not offload due to strict security measures, compensating other resources like battery power and cost. Application nature also motivates offloading to eliminate redundant processing (e.g., MAR based training where a set of clients execute a similar type of processing). As MEC enabled 5G UDN deploy base stations in the vicinity of the users, service offloading while guaranteeing the critical service levels will be more practical.

2) *Research Problems*

- 5G UDN equipped with MEC may provide multiple potential servers to offload. What algorithms can be considered to select the best server to offload?
- In the vicinity of multiple potential servers, is it possible to offload to multiple servers simultaneously?
- How the offloading decision should be taken with increased mobility due to the reduced cell radius of 5G small cells?

- How the offloading process will dynamically adapt based on channel conditions so that the strict application requirements are guaranteed?

3) Preliminary Solutions

Research work on multipath offloading for MAR [225] discusses a multi-server, multiple-links architecture for offloading to companion devices, edge and cloud, and proposes an algorithm for task allocation. Latency aware hybrid edge and cloud offloading [250] makes use of proximity of MEC in 5G to offload AR processing to either edge or cloud intelligently. A method to distribute more data to the path with lower packet loss in multipath offloading [256] is proposed for better video streaming.

4) Future Directives

Even though computational offloading is a widely discussed topic among the researchers, utilization of 5G UDN features with MEC is a barely investigated area. With the drastic changes proposed with 5G (i.e., mmWaves, small cells, massive MIMO, beamforming), more sophisticated and evolved network architectures will emerge with more resources available close to the user. Offloading algorithms [225] can consider these features and can be improved to enable dynamic and more sophisticated offloading scenarios suitable for MAR applications. The adaptive multipath offloading subjected to packet loss constraint [256] can be applied in MEC enabled 5G UDN based MAR communications, as the users are in the vicinity of multiple base stations. Design of novel application-specific protocols to optimize offloading decisions is also a possible research direction.

E. Service Migration

1) Lessons Learned

Service migration considering the specific application of MAR is a barely investigated area. Few research efforts investigate the service migrations in mobile edge clouds to address the performance degradation issue with user mobility. With the increased mobility in 5G UDN, service migration will play a crucial role to ensure service continuity. With the changes expected in the network architectures in 5G era enhanced with SDN and NFV technologies, the potential for improvements in service migration is substantial.

2) Research Problems

- How to ensure proper service migration for MAR users with high mobility in MEC enabled 5G UDN?
- What measures can be taken to minimize downtime for MAR applications which require extremely low latency?
- What novel algorithms should be developed for successful service migration in large scale MEC environments?

3) Preliminary Solutions

Few existing efforts discuss the solutions for service migration issues concerning user mobility. They are, mobility aware dynamic service placement for MEC [234], prioritized service migration for high mobility users among the ordinary users [257], FMeC [233] that assures users are always connected to the optimal edge. Iterative service migration [232] transfers memory pages while the service is running. With the iterative migration, only a small portion of the in-memory

state must be transferred, ensuring minimal service downtime for MAR applications.

4) Future Directives

Prediction of user mobility in 5G UDN enabled by the increased base station density will allow the network to determine the optimal MEC server for the service migration. AI and ML based predictive algorithms considering multiple cost elements (e.g., jitter, packet loss, present workload, throughput) are promising research efforts to facilitate service migrations in future MAR. Iterative service migration puts an extra burden on the network due to redundant transmissions. Despite the capability of 5G in provisioning high bandwidth services, an efficient way of achieving iterative service migration should be researched. The distributed architectures in 5G enabled by SDN and NFV need more emphasis on the security of service migration. Blockchain based novel security algorithm designs could also be a potential research direction because the network is more distributed [258].

F. Security

1) Lessons Learned

MAR security discussions heavily focus on the security implementations of a standalone system (i.e., within the device) and mostly consider the application level security. Security of a networked MAR system needs more attention as the future MAR network architectures will be complex. The proposed edge based SECaaS mechanisms also need substantial improvements and should be tailored for 5G UDN. User friendly, lightweight wearable device designs and the complex on-device security algorithms are conflicting requirements in future MAR. Conversely, cloud based security algorithms do not guarantee ultra-low latency service levels. The future service provision over the programmable 5G networks using SDN, NFV, network slicing and MEC technologies drastically increase the scope for MAR security. D2D communication among MAR devices in a collaborative environment also needs significant consideration for security. Implementing adaptive security mechanisms for complex application environments is discussed, however, the discussions are limited to securing the visual output.

2) Research Problems

- What are the potential security threats and their implications at the device, edge and cloud layers for future 5G networked MAR systems?
- What are the possible security solutions for mitigating the security threats at each layer?
- How to manage the trade-off between the resources and the overhead introduced by the security solutions?
- How to develop robust and adaptive security mechanisms on the run time environment based on varying application demands?

3) Preliminary Solutions

Adaptive policies to secure visual output in AR systems using reinforcement learning and fog computing is one solution [259]. A drawback of this solution is the degradation of frame rate. Edge based security solutions for industrial AR [260], consider the concept of implementing the security

mechanisms outside the device to suit the complex environments.

4) *Future Directives*

Seamless migration of services between edge and cloud is proposed in osmotic computing [261]. Seamless migration of security services can be done via osmotic computing for the hybrid MAR systems. The complexity of the security algorithms and the execution cost of such algorithms in an energy constrained device are two conflicting objectives. However, deploying lightweight security algorithms at the 5G UDN equipped with MEC is a potential solution and should be further researched. For the ultra-low latency use cases, a compromise between additional security and the introduced latency needs to be further researched. Moreover, instead of having fixed device-level policies, MEC based security can be made adaptive with AI, ML and big data analysis. Security of collaborative MAR, capable of D2D communication, has not been a focus of the researchers. The complexity of future 5G MAR architectures can be facilitated with Zero touch Network and Service Management (ZSM) [262] by ETSI, which is a significant initiative towards full automation of networks. Therefore, ZSM security will also be a key topic and need to be discussed concerning future MAR. The emergence of quantum computing makes the present security mechanisms vulnerable [263]. Therefore, quantum resistant security for MAR systems should be researched.

G. Privacy

1) *Lessons Learned*

The future 5G networked MAR systems must implement the controls for privacy protection as the systems are distributed and the attack surface is broad. In the meantime, the features of SDN, NFV, network slicing in 5G networks can be effectively utilized to implement more sophisticated privacy protection mechanisms for MAR systems. The privacy protection approaches can be tailored based on diverse MAR application requirements using the SDN. In addition to data privacy, location privacy will also be trivial as location information is a key in MAR service provision for most outdoor MAR applications. Current discussions on privacy protection for MAR is limited, but a redesign of the approaches is needed in future dynamic and distributed 5G MAR systems. Offloading privacy protection mechanisms to MEC enabled 5G UDN can be considered as a potential focus area for emerging MAR systems.

2) *Research Problems*

- What new privacy threats are arising and their implications, especially with the complex MAR systems spanning MEC and cloud in the future?
- How to define privacy protection mechanisms, particularly in the future when a significant part of the processing is offloaded outside the terminal MAR devices?
- How to develop robust and adaptive privacy protection mechanisms on the run time environment based on varying application demands?

3) *Preliminary Solutions*

A system that addresses the privacy issues in MAR for Tele-Assistance applications [264] considers image privacy.

Identified privacy regions are encrypted using a profile based privacy protection algorithm so that only the users with a valid access profile can decrypt the image. Privacy solutions specific to edge computing based applications [265] proposes basic privacy building blocks including differential privacy, paving the way for more sophisticated and application specific privacy solutions.

4) *Future Directives*

Future research must focus on considering the privacy-by-design approach during the implementation of 5G MAR systems. Since 5G services are provided via small cell UDN, the user localization is easy, which jeopardizes the location privacy. More emphasis should be taken to ensure the location privacy of both the users and bystanders. The small form factor wearable devices are not easily noticeable for bystanders. Therefore standardization bodies should impose guidelines on their proper usage (similar to General Data Protection Regulation (GDPR)). Exploiting the increased computational capabilities of the MEC enabled 5G UDN, AI and ML based complex and adaptive privacy protection mechanisms can be imposed in the future for privacy protection in MAR.

H. Remaining Challenges and Open Issues (Deployment Challenges)

1) *Reduced Cell Radius of UDN and Higher Blockage of mmWaves*

mmWave propagation exhibits a significantly larger wireless link propagation loss [266]. This creates the need for small cell deployments for MAR devices to maintain Line-Of-Sight (LOS) communication to achieve high bandwidth. mmWave propagation is also susceptible to blockage effects [266]. Even though small cell deployment is a viable solution for simple indoor environments [267], it still poses a considerable challenge in outdoor urban areas due to the obstructions [268]. While maintaining LOS is difficult in outdoor urban environments, the high base station density in 5G UDN allows the users to have simultaneous connections to multiple base stations as in Coordinated MultiPoint Joint Transmission (CoMP-JT) [269]. Due to high dynamic blockages in 5G systems, learning and prediction based blockage algorithms to predict and remove blockages to ensure priority for LOS links [270] is a viable solution for this problem. For complex but well known indoor environments such as factory premises, visual detection based blockage prediction algorithms [271] is an interesting approach to ensure the availability of LOS links to the user.

2) *Higher Mobility due to Small Cells*

Ensuring higher bandwidth and low-latency for outdoor MAR users is challenging due to user mobility. Unlike in lower frequency networks, mmWave UDN comprise a higher number of cells having reduced cell radius. Intuitively, the handover frequency is higher in mmWave UDN. Somehow, the user must have at least one high-quality link and a minimal switching time between base stations for proper MAR functionality. Multi-connectivity [269] addresses the problem to a certain extent. One device being connected to multiple base stations and the signal transmission and reception via

multiple antennas pave the way for position and orientation tracking [272] of the device. The current tracking information supplemented by optional historical data makes it possible to select the most suitable current base station to serve and next base stations [273] to handover. This enables faster mobility and achieves higher beamforming gain, helping MAR users to maintain higher data rate with low-latency.

3) Need for high capacity uplink

MAR applications continuously stream content, requiring high data rates for both uplink and downlink communications. The current focus of MNO is to significantly allocate spectrum for downlink data delivery to maximize spectral efficiency, which does not fit with future MAR requirements. One possible solution is establishing Local 5G Operators (L5GO) [274], [275] to serve case-specific and location-specific use cases such as industrial MAR networks. Since the network itself is tailored to serve the use case, the uplink capacity problem can be addressed. However, the uplink data rate challenge still exists for users with the general mobile device based MAR applications. Flexible adjustments of uplink and downlink resources enabled by dynamic Time-Division Duplexing (TDD) with cross-link interference mitigation [276] is a viable approach for MNOs to maximize the uplink capacity on-demand with the small cell deployments. This makes the network responsive based on the traffic demand in events such as a sudden increase of MAR users in a particular area. Network slicing enables the creation of end-to-end logical networks on top of existing resources to ensure guaranteed QoS. The flexibility of slice creation can be exploited by MNO to define per application network slices [277], with dynamic resource scheduling [278] to achieve automatic and efficient resource optimization. Thus the uplink capacity can be allocated dynamically based on application demands.

4) Need for small form factor devices

Modern and future MAR requires easy to handle, lightweight and wearable devices, especially for the use of outdoor environments. The high throughput is achievable with multi-antenna transmissions. Implementing MIMO within small form factor and limited energy devices is challenging. Techniques in RF domain such as high-efficiency integrated Complementary Metal Oxide Semiconductor (CMOS) Power Amplifiers (PA) are highly desirable for portable devices for improved battery life, reduced form factor [279]. Co-integrating the miscellaneous components of the RF front end in one Si-CMOS-compatible technology [280] such as III-V devices and their monolithic integration with CMOS circuits [281] is also proposed for mmWaves to design small form factor devices in 5G.

5) Artificial Intelligence (AI) and Machine Learning (ML) for MAR

AI and ML techniques have been extensively discussed with 5G and beyond 5G networks [282] and researched in various application domains including speech recognition, image classification, image recognition. While 5G envisions a network with edge intelligence [283], there is a vast potential in bridging AI and MAR to create a rich and intuitive MAR experience. AI/ML techniques can be implemented in various image processing stages to identify features with

better accuracy to complement the AR operation. Integrating AI-based voice recognition techniques into wearable MAR devices could be efficient under noisy conditions in diverse outdoor environments. The computing resources available at the MEC enabled 5G UDN coupled with communication efficient edge AI algorithms [284], will allow the execution of complex AI-based algorithms, facilitating edge based and hybrid MAR architectures.

VII. CONCLUSIONS

The future MAR applications will bring an added value to numerous application domains by enhancing the quality of user experience and well-being of the sophisticated next generation society. The extreme versatile demands of such applications should be supported by different network formulations, such as cloud based, edge based, localized and hybrid architectures. Extremely high bandwidth, ultra-low latency and massive connectivity offered by future 5G systems envision a promising future for MAR applications along with the complimenting technology MEC. Throughout the paper, we have discussed the coexistence and significance of MAR applications under the patronage of 5G MEC technology. We have presented an extensive literature survey highlighting how 5G and MEC are advocating future MAR applications to overcome the current technological barriers. Zero touch networking technologies and high precision computation capabilities are getting the attraction of numerous future MAR applications. However, plenty of technological aspects remaining to be addressed in the computation and communication technologies to reach the envisioned future promised by MAR.

ACKNOWLEDGMENT

This work is supported by Academy of Finland in 6Genesis Flagship (grant no. 318927) and 5GEAR (Grant No. 319669) projects, and European Union in RESPONSE 5G (Grant No: 789658) project.

REFERENCES

- [1] C. Westphal, "Challenges in Networking to support Augmented Reality and Virtual Reality," *IEEE ICNC*, 2017.
- [2] "Multi-access Edge Computing (MEC); Phase 2: Use Cases and Requirements." [Online]. Available: https://www.etsi.org/deliver/etsi_gs/MEC/001_099/002/02.01.01_60/gs_MEC002v020101p.pdf
- [3] R. Azuma, Y. Baillot, R. Behringer, S. Feiner, S. Julier, and B. MacIntyre, "Recent Advances in Augmented Reality," *IEEE computer graphics and applications*, vol. 21, no. 6, pp. 34–47, 2001.
- [4] P. Milgram and F. Kishino, "A Taxonomy of Mixed Reality Visual Displays," *IEICE TRANSACTIONS on Information and Systems*, vol. 77, no. 12, pp. 1321–1329, 1994.
- [5] D. Chatzopoulos, C. Bermejo, Z. Huang, and P. Hui, "Mobile Augmented Reality Survey: From Where We are to Where We Go," *IEEE Access*, vol. 5, pp. 6917–6950, 2017.
- [6] R. Xiao, J. Schwarz, N. Throm, A. D. Wilson, and H. Benko, "MRTouch: Adding Touch Input to Head-mounted Mixed Reality," *IEEE transactions on visualization and computer graphics*, vol. 24, no. 4, pp. 1653–1660, 2018.
- [7] F. Zhou, H. B.-L. Duh, and M. Billinghurst, "Trends in Augmented Reality Tracking, Interaction and Display: A Review of Ten Years of ISMAR," in *Proceedings of the 7th IEEE/ACM international symposium on mixed and augmented reality*. IEEE Computer Society, 2008, pp. 193–202.

- [8] J. P. Rolland, L. D. Davis, and Y. Baillet, "A Survey of Tracking Technologies for Virtual Environments," in *Fundamentals of wearable computers and augmented reality*. CRC Press, 2001, pp. 83–128.
- [9] M. Bajura and U. Neumann, "Dynamic Registration Correction in Video-based Augmented Reality Systems," *IEEE Computer Graphics and Applications*, vol. 15, no. 5, pp. 52–60, 1995.
- [10] H. Kato and M. Billinghurst, "Marker Tracking and HMD Calibration for a Video-based Augmented Reality Conferencing System," in *Proceedings 2nd IEEE and ACM International Workshop on Augmented Reality (IWAR'99)*. IEEE, 1999, pp. 85–94.
- [11] G. Simon, A. W. Fitzgibbon, and A. Zisserman, "Markerless Tracking using Planar Structures in the Scene," in *Proceedings IEEE and ACM International Symposium on Augmented Reality (ISAR 2000)*. IEEE, 2000, pp. 120–128.
- [12] V. Geroimenko, "Augmented Reality Technology and Art: The Analysis and Visualization of Evolving Conceptual Models," in *2012 16th International Conference on Information Visualisation*. IEEE, 2012, pp. 445–453.
- [13] R. T. Azuma, B. R. Hoff, H. E. Neely III, R. Sarfaty, M. J. Daily, G. Bishop, V. Chi, G. Welch, U. Neumann, S. You, et al., "Making Augmented Reality Work Outdoors Requires Hybrid Tracking," in *Proceedings of the First International Workshop on Augmented Reality*, vol. 1, 1998.
- [14] I. Rabbi and S. Ullah, "A Survey on Augmented Reality Challenges and Tracking," *Acta graphica: znanstveni časopis za tiskarstvo i grafičke komunikacije*, vol. 24, no. 1-2, pp. 29–46, 2013.
- [15] P. Mistry, P. Maes, and L. Chang, "WUW-Wear Ur World: A Wearable Gestural Interface," in *CHI'09 extended abstracts on Human factors in computing systems*. ACM, 2009, pp. 4111–4116.
- [16] J. Schönig, M. Rohs, S. Kratz, M. Löchtefeld, and A. Krüger, "Map Torchlight: A Mobile Augmented Reality Camera Projector Unit," in *CHI'09 Extended Abstracts on Human Factors in Computing Systems*. ACM, 2009, pp. 3841–3846.
- [17] D. Wagner and D. Schmalstieg, "Handheld Augmented Reality Displays," in *IEEE Virtual Reality Conference (VR 2006)*. IEEE, 2006, pp. 321–321.
- [18] K. Kiyokawa, Y. Kurata, and H. Ohno, "An Optical See-through Display for Mutual Occlusion of Real and Virtual Environments," in *Proceedings IEEE and ACM International Symposium on Augmented Reality (ISAR 2000)*. IEEE, 2000, pp. 60–67.
- [19] A. State, K. Keller, and H. Fuchs, "Simulation-based Design and Rapid Prototyping of a Parallax-Free, Orthoscopic Video See-through Head-mounted Display," in *Fourth IEEE and ACM International Symposium on Mixed and Augmented Reality (ISMAR'05)*. IEEE, 2005, pp. 28–31.
- [20] C. Bermejo and P. Hui, "A Survey on Haptic Technologies for Mobile Augmented Reality," *arXiv preprint arXiv:1709.00698*, 2017.
- [21] G. Papagiannakis, G. Singh, and N. Magnenat-Thalmann, "A Survey of Mobile and Wireless Technologies for Augmented Reality Systems," *Computer Animation and Virtual Worlds*, vol. 19, no. 1, pp. 3–22, 2008.
- [22] D. Van Krevelen and R. Poelman, "Augmented Reality: Technologies, Applications, and Limitations," *Vrije Univ. Amsterdam, Dep. Comput. Sci.*, 2007.
- [23] P. Haynes, S. Hehl-Lange, and E. Lange, "Mobile Augmented Reality for Flood Visualisation," *Environmental modelling & software*, vol. 109, pp. 380–389, 2018.
- [24] M. H. Kurniawan, G. Witjaksono, et al., "Human Anatomy Learning Systems using Augmented Reality on Mobile Application," *Procedia Computer Science*, vol. 135, pp. 80–88, 2018.
- [25] P. Dangkham, "Mobile Augmented Reality on Web-based for the Tourism using HTML5," in *2018 International Conference on Information Networking (ICOIN)*. IEEE, 2018, pp. 482–485.
- [26] S. Larabi, "Augmented Reality for Mobile Devices: Textual Annotation of Outdoor Locations," in *Augmented Reality and Virtual Reality*. Springer, 2018, pp. 353–362.
- [27] A. B. Craig, *Understanding Augmented Reality: Concepts and Applications*. Newnes, 2013.
- [28] "Google Glass." [Online]. Available: <https://www.google.com/glass/start/>
- [29] O. J. Muensterer, M. Lacher, C. Zoeller, M. Bronstein, and J. Kübler, "Google Glass in Pediatric Surgery: An Exploratory Study," *International journal of surgery*, vol. 12, no. 4, pp. 281–289, 2014.
- [30] M. C. Leue, T. Jung, and D. tom Dieck, "Google Glass Augmented Reality: Generic Learning Outcomes for Art Galleries," in *Information and communication technologies in tourism 2015*. Springer, 2015, pp. 463–476.
- [31] "Pokémon Go." [Online]. Available: <https://www.pokemongo.com/en-us/>
- [32] "Google Lens." [Online]. Available: <https://lens.google.com/>
- [33] "Microsoft HoloLens." [Online]. Available: <https://www.microsoft.com/en-us/hololens/>
- [34] P. Jain, J. Manweiler, and R. Roy Choudhury, "Overlay: Practical mobile augmented reality," in *Proceedings of the 13th Annual International Conference on Mobile Systems, Applications, and Services*, 2015, pp. 331–344.
- [35] H. Chen, Y. Dai, H. Meng, Y. Chen, and T. Li, "Understanding the Characteristics of Mobile Augmented Reality Applications," in *2018 IEEE International Symposium on Performance Analysis of Systems and Software (ISPASS)*. IEEE, 2018, pp. 128–138.
- [36] S. Ganapathy, "Design Guidelines for Mobile Augmented Reality: User Experience," in *Human Factors in Augmented Reality Environments*. Springer, 2013, pp. 165–180.
- [37] R. T. Azuma et al., "The Challenge of making Augmented Reality work Outdoors," *Mixed reality: Merging real and virtual worlds*, pp. 379–390, 1999.
- [38] B. Shi, J. Yang, Z. Huang, and P. Hui, "Offloading Guidelines for Augmented Reality Applications on Wearable Devices," in *Proceedings of the 23rd ACM international conference on Multimedia*. ACM, 2015, pp. 1271–1274.
- [39] R. Shea, A. Sun, S. Fu, and J. Liu, "Towards Fully Offloaded Cloud-based AR: Design, Implementation and Experience," in *Proceedings of the 8th ACM on Multimedia Systems Conference*. ACM, 2017, pp. 321–330.
- [40] W. Zhang, B. Han, and P. Hui, "On the Networking Challenges of Mobile Augmented Reality," in *Proceedings of the Workshop on Virtual Reality and Augmented Reality Network*, 2017, pp. 24–29.
- [41] A. Younis, T. X. Tran, B. Qiu, and D. Pompili, "Demo Abstract: Mobile Augmented Reality leveraging Cloud Radio Access Networks," in *2019 IEEE 20th International Symposium on "A World of Wireless, Mobile and Multimedia Networks" (WoWMoM)*. IEEE, 2019, pp. 1–3.
- [42] Y. C. Hu, M. Patel, D. Sabella, N. Sprecher, and V. Young, "Mobile Edge Computing - A Key Technology towards 5G," *ETSI white paper*, vol. 11, no. 11, pp. 1–16, 2015.
- [43] T. Taleb, K. Samdanis, B. Mada, H. Flinck, S. Dutta, and D. Sabella, "On Multi-access Edge Computing: A Survey of the Emerging 5G Network Edge Cloud Architecture and Orchestration," *IEEE Communications Surveys & Tutorials*, vol. 19, no. 3, pp. 1657–1681, 2017.
- [44] W. Zhang, B. Han, and P. Hui, "Jaguar: Low Latency Mobile Augmented Reality with Flexible Tracking," in *Proceedings of the 26th ACM international conference on Multimedia*, 2018, pp. 355–363.
- [45] L. Liu, H. Li, and M. Gruteser, "Edge Assisted Real-time Object Detection for Mobile Augmented Reality," in *The 25th Annual International Conference on Mobile Computing and Networking*, 2019, pp. 1–16.
- [46] X. Qiao, P. Ren, S. Dustdar, and J. Chen, "A New Era for Web AR with Mobile Edge Computing," *IEEE Internet Computing*, vol. 22, no. 4, pp. 46–55, 2018.
- [47] I. E. Sutherland, "A Head-mounted Three Dimensional Display," in *Proceedings of the December 9-11, 1968, fall joint computer conference, Part I*. ACM, 1968, pp. 757–764.
- [48] T. P. Caudell and D. W. Mizell, "Augmented Reality: An Application of Heads-up Display Technology to Manual Manufacturing Processes," in *Proceedings of the twenty-fifth Hawaii international conference on system sciences*, vol. 2. IEEE, 1992, pp. 659–669.
- [49] R. T. Azuma, "A Survey of Augmented Reality," *Presence: Teleoperators & Virtual Environments*, vol. 6, no. 4, pp. 355–385, 1997.
- [50] J. Carmigniani, B. Furht, M. Anisetti, P. Ceravolo, E. Damiani, and M. Ivkovic, "Augmented Reality Technologies, Systems and Applications," *Multimedia tools and applications*, vol. 51, no. 1, pp. 341–377, 2011.
- [51] N. I. Adhani and R. D. R. Awang, "A Survey of Mobile Augmented Reality Applications," in *1st International Conference on Future Trends in Computing and Communication Technologies*, 2012, pp. 89–96.
- [52] A. Sanna and F. Manuri, "A Survey on Applications of Augmented Reality," *Advances in Computer Science: an International Journal*, vol. 5, no. 1, pp. 18–27, 2016.
- [53] S. K. Kim, S.-J. Kang, Y.-J. Choi, M.-H. Choi, and M. Hong, "Augmented-Reality Survey: From Concept to Application," *KSII Transactions on Internet & Information Systems*, vol. 11, no. 2, 2017.
- [54] T. Höllerer and S. Feiner, "Mobile Augmented Reality," *Telegeoinformatics: Location-based computing and services*, vol. 21, 2004.
- [55] G. Liu and D. Jiang, "5G: Vision and Requirements for Mobile Communication System towards Year 2020," *Chinese Journal of Engineering*, vol. 2016, 2016.

- [56] “Augmented Reality and Virtual Reality (ARVR) Market Research Report - Global Forecast till 2025.” [Online]. Available: <https://www.marketresearchfuture.com/reports/augmented-reality-virtual-reality-market-6884>
- [57] Z. Huang, W. Li, P. Hui, and C. Peylo, “CloudRidAR: A Cloud-based Architecture for Mobile Augmented Reality,” in *Proceedings of the 2014 workshop on Mobile augmented reality and robotic technology-based systems*. ACM, 2014, pp. 29–34.
- [58] B.-R. Huang, C. H. Lin, and C.-H. Lee, “Mobile Augmented Reality based on Cloud Computing,” in *Anti-counterfeiting, Security, and Identification*. IEEE, 2012, pp. 1–5.
- [59] M. Noreikis, Y. Xiao, and A. Ylä-Jääski, “Seenav: Seamless and Energy-efficient Indoor Navigation using Augmented Reality,” in *Proceedings of the Thematic Workshops of ACM Multimedia 2017*. ACM, 2017, pp. 186–193.
- [60] B.-S. P. Lin, W.-H. Tsai, C. Wu, P. Hsu, J. Huang, and T.-H. Liu, “The Design of Cloud-based 4G/LTE for Mobile Augmented Reality with Smart Mobile Devices,” in *2013 IEEE Seventh International Symposium on Service-Oriented System Engineering*. IEEE, 2013, pp. 561–566.
- [61] P. Vecchio, F. Mele, L. T. De Paolis, I. Epicoco, M. Mancini, and G. Aloisio, “Cloud Computing and Augmented Reality for Cultural Heritage,” in *International Conference on Augmented and Virtual Reality*. Springer, 2015, pp. 51–60.
- [62] J. A. Juanes, D. Hernández, P. Ruisoto, E. García, G. Villarrubia, and A. Prats, “Augmented Reality Techniques, using Mobile Devices, for Learning Human Anatomy,” in *Proceedings of the Second International Conference on Technological Ecosystems for Enhancing Multicultural-ity*. ACM, 2014, pp. 7–11.
- [63] K. Ab Aziz, N. A. Ab Aziz, A. M. Yusof, and A. Paul, “Potential for providing Augmented Reality Elements in Special Education via Cloud Computing,” *Procedia Engineering*, vol. 41, pp. 333–339, 2012.
- [64] P. Jain, J. Manweiler, and R. Roy Choudhury, “Low Bandwidth Offload for Mobile AR,” in *Proceedings of the 12th International Conference on emerging Networking EXperiments and Technologies*. ACM, 2016, pp. 237–251.
- [65] K. Chen, T. Li, H.-S. Kim, D. E. Culler, and R. H. Katz, “MARVEL: Enabling Mobile Augmented Reality with Low Energy and Low Latency,” in *Proceedings of the 16th ACM Conference on Embedded Networked Sensor Systems*, ser. SenSys '18. New York, NY, USA: ACM, 2018, pp. 292–304. [Online]. Available: <http://doi.acm.org/10.1145/3274783.3274834>
- [66] GSMA, “Cloud AR/VR Whitepaper,” GSMA Future Networks, April 2019. [Online]. Available: <https://www.gsma.com/futurenetworks/wiki/cloud-ar-vr-whitepaper/>
- [67] M. Schneider, J. Rambach, and D. Stricker, “Augmented Reality based on Edge Computing using the Example of Remote Live Support,” in *2017 IEEE International Conference on Industrial Technology (ICIT)*. IEEE, 2017, pp. 1277–1282.
- [68] P. Zhou, W. Zhang, T. Braud, P. Hui, and J. Kangasharju, “Enhanced Augmented Reality Applications in Vehicle-to-Edge Networks,” in *2019 22nd Conference on Innovation in Clouds, Internet and Networks and Workshops (ICIN)*. IEEE, 2019, pp. 167–174.
- [69] M. Erol-Kantarci and S. Sukhmani, “Caching and Computing at the Edge for Mobile Augmented Reality and Virtual Reality (AR/VR) in 5G,” in *Ad Hoc Networks*. Springer, 2018, pp. 169–177.
- [70] W. Liu, J. Ren, G. Huang, Y. He, and G. Yu, “Data Offloading and Sharing for Latency Minimization in Augmented Reality Based on Mobile-Edge Computing,” in *2018 IEEE 88th Vehicular Technology Conference (VTC-Fall)*. IEEE, 2018, pp. 1–5.
- [71] P. Zhou, W. Zhang, T. Braud, P. Hui, and J. Kangasharju, “Arve: Augmented Reality Applications in Vehicle to Edge Networks,” in *Proceedings of the 2018 Workshop on Mobile Edge Communications*, 2018, pp. 25–30.
- [72] A. Mulloni, H. Seichter, and D. Schmalstieg, “Handheld Augmented Reality Indoor Navigation with Activity-based Instructions,” in *Proceedings of the 13th international conference on human computer interaction with mobile devices and services*. ACM, 2011, pp. 211–220.
- [73] M. Gervautz and D. Schmalstieg, “Anywhere Interfaces using Handheld Augmented Reality,” *Computer*, vol. 45, no. 7, pp. 26–31, 2012.
- [74] P. Renukdas, R. Ghundiyaal, H. Gadhill, and V. Pathare, “Markerless Augmented Reality Android App for Interior Decoration,” *International Journal of Engineering Research & Technology (IJERT)*, vol. 2, no. 4, pp. 1367–1373, 2013.
- [75] J. Ren, Y. He, G. Huang, G. Yu, Y. Cai, and Z. Zhang, “An Edge-Computing based Architecture for Mobile Augmented Reality,” *IEEE Network*, 2019.
- [76] P. Fraga-Lamas, T. M. Fernández-Caramés, Ó. Blanco-Novoa, and M. A. Vilar-Montesinos, “A Review on Industrial Augmented Reality Systems for the Industry 4.0 Shipyard,” *IEEE Access*, vol. 6, pp. 13 358–13 375, 2018.
- [77] T. Fernández-Caramés, P. Fraga-Lamas, M. Suárez-Albela, and M. Vilar-Montesinos, “A Fog Computing and Cloudlet based Augmented Reality System for the Industry 4.0 Shipyard,” *Sensors*, vol. 18, no. 6, p. 1798, 2018.
- [78] P. Ren, X. Qiao, J. Chen, and S. Dustdar, “Mobile Edge Computing—A Booster for the Practical Provisioning Approach of Web-Based Augmented Reality,” in *2018 IEEE/ACM Symposium on Edge Computing (SEC)*. IEEE, 2018, pp. 349–350.
- [79] O. Blanco-Novoa, T. M. Fernández-Caramés, P. Fraga-Lamas, and M. A. Vilar-Montesinos, “A Practical Evaluation of Commercial Industrial Augmented Reality Systems in an Industry 4.0 Shipyard,” *IEEE Access*, vol. 6, pp. 8201–8218, 2018.
- [80] Y. Kim, S. Hong, and G. J. Kim, “Augmented Reality-based Remote Coaching for Fast-paced Physical Task,” *Virtual Reality*, vol. 22, no. 1, pp. 25–36, 2018.
- [81] Google, “Live View on Google Maps.” [Online]. Available: <https://support.google.com/maps/answer/9332056?co=GENIE.Platform%3DAndroid&hl=en>
- [82] Google, “Google Translate.” [Online]. Available: <https://translate.google.com/>
- [83] V. Vlahakis, M. Ioannidis, J. Karigiannis, M. Tsoiros, M. Gounaris, D. Stricker, T. Gleue, P. Daehne, and L. Almeida, “Archeoguide: An Augmented Reality Guide for Archaeological Sites,” *IEEE Computer Graphics and Applications*, vol. 22, no. 5, pp. 52–60, 2002.
- [84] P. Föckler, T. Zeidler, B. Brombach, E. Bruns, and O. Bimber, “PhoneGuide: Museum Guidance Supported by On-Device Object Recognition on Mobile Phones,” in *Proceedings of the 4th international conference on Mobile and ubiquitous multimedia*. ACM, 2005, pp. 3–10.
- [85] A. Damala, P. Cubaud, A. Bationo, P. Houlier, and I. Marchal, “Bridging the Gap between the Digital and the Physical: Design and Evaluation of a Mobile Augmented Reality Guide for the Museum Visit,” in *Proceedings of the 3rd international conference on Digital Interactive Media in Entertainment and Arts*. ACM, 2008, pp. 120–127.
- [86] C.-Y. Chen, B. R. Chang, and P.-S. Huang, “Multimedia Augmented Reality Information System for Museum Guidance,” *Personal and ubiquitous computing*, vol. 18, no. 2, pp. 315–322, 2014.
- [87] A. Mitaritonna, M. J. Abásolo, and F. Montero, “An Augmented Reality-based Software Architecture to Support Military Situational Awareness,” in *2020 International Conference on Electrical, Communication, and Computer Engineering (ICECCE)*. IEEE, 2020, pp. 1–6.
- [88] N. D. Macchiarella, D. Liu, S. N. Gangadharan, D. A. Vincenzi, and A. E. Majoros, “Augmented Reality as a Training Medium for Aviation/Aerospace Application,” in *Proceedings of the Human Factors and Ergonomics Society Annual Meeting*, vol. 49, no. 25. SAGE Publications Sage CA: Los Angeles, CA, 2005, pp. 2174–2178.
- [89] S. Kim and A. K. Dey, “Simulated Augmented Reality Windshield Display as a Cognitive Mapping Aid for Elder Driver Navigation,” in *Proceedings of the SIGCHI Conference on Human Factors in Computing Systems*. ACM, 2009, pp. 133–142.
- [90] J.-H. Lin, C.-M. Lin, C.-R. Dow, and C.-Q. Wang, “Design and Implement Augmented Reality for Supporting Driving Visual Guidance,” in *2011 Second International Conference on Innovations in Bio-inspired Computing and Applications*. IEEE, 2011, pp. 316–319.
- [91] 3GPP, “Study on Communication Services for Critical Medical Applications,” Technical Report, Sep 2019. [Online]. Available: https://www.3gpp.org/ftp/Specs/archive/22_series/22.826
- [92] ABIresearch, “Augmented and Virtual Reality: The First Wave of 5G Killer Apps,” 2017. [Online]. Available: <https://www.qualcomm.com/media/documents/files/augmented-and-virtual-reality-the-first-wave-of-5g-killer-apps.pdf>
- [93] T. Braud, F. H. Bijarbooneh, D. Chatzopoulos, and P. Hui, “Future Networking Challenges: The Case of Mobile Augmented Reality,” in *2017 IEEE 37th International Conference on Distributed Computing Systems (ICDCS)*. IEEE, 2017, pp. 1796–1807.
- [94] 3GPP, “Study on Communication for Automation in Vertical Domains (CAV),” Technical Report, Dec 2018. [On-

- line]. Available: <https://portal.3gpp.org/desktopmodules/Specifications/SpecificationDetails.aspx?specificationId=3187>
- [95] A. Reiter and T. Zefferer, "Paving the Way for Security in Cloud-based Mobile Augmentation Systems," in *2015 3rd IEEE International Conference on Mobile Cloud Computing, Services, and Engineering*. IEEE, 2015, pp. 89–98.
- [96] D. Yuan, K. Ota, M. Dong, X. Zhu, T. Wu, L. Zhang, and J. Ma, "Intrusion Detection for Smart Home Security Based on Data Augmentation with Edge Computing," in *ICC 2020-2020 IEEE International Conference on Communications (ICC)*. IEEE, 2020, pp. 1–6.
- [97] K. Kumar and Y.-H. Lu, "Cloud Computing for Mobile Users: Can Offloading Computation Save Energy?" *Computer*, vol. 43, no. 4, pp. 51–56, 2010.
- [98] IKEA, "IKEA Place." [Online]. Available: https://play.google.com/store/apps/details?id=com.inter_ikea.place
- [99] 3GPP, "Requirements for Evolved UTRA (E-UTRA) and Evolved UTRAN (E-UTRAN)," Technical Report, Dec 2009. [Online]. Available: https://www.3gpp.org/ftp/Specs/archive/25_series/25.913/
- [100] Ericsson, "LTE – An Introduction," 2009.
- [101] Motorola, "Realistic LTE Performance," Motorola Technical Report, 2009.
- [102] X. Qiao, P. Ren, S. Dustdar, L. Liu, H. Ma, and J. Chen, "Web AR: A Promising Future for Mobile Augmented Reality-State of the Art, Challenges, and Insights," *Proceedings of the IEEE*, vol. 107, no. 4, pp. 651–666, 2019.
- [103] J. Navarro-Ortiz, P. Romero-Diaz, S. Sendra, P. Ameigeiras, J. J. Ramos-Munoz, and J. M. Lopez-Soler, "A Survey on 5G Usage Scenarios and Traffic Models," *IEEE Communications Surveys Tutorials*, vol. 22, no. 2, pp. 905–929, 2020.
- [104] J. G. Andrews, S. Buzzi, W. Choi, S. V. Hanly, A. Lozano, A. C. Soong, and J. C. Zhang, "What will 5G be?" *IEEE Journal on selected areas in communications*, vol. 32, no. 6, pp. 1065–1082, 2014.
- [105] M. Liyanage, A. Gurtov, and M. Ylianttila, *Software Defined Mobile Networks (SDMN): Beyond LTE Network Architecture*. John Wiley & Sons, 2015.
- [106] A. Osseiran, F. Boccardi, V. Braun, K. Kusume, P. Marsch, M. Maternia, O. Queseth, M. Schellmann, H. Schotten, H. Taoka, et al., "Scenarios for 5G Mobile and Wireless Communications: The Vision of the METIS Project," *IEEE communications magazine*, vol. 52, no. 5, pp. 26–35, 2014.
- [107] A. I. Sulyman, A. T. Nassar, M. K. Samimi, G. R. MacCartney, T. S. Rappaport, and A. Alsanie, "Radio Propagation Path Loss Models for 5G Cellular Networks in the 28 GHz and 38 GHz millimeter-wave Bands," *IEEE communications magazine*, vol. 52, no. 9, pp. 78–86, 2014.
- [108] T. Bai, A. Alkhateeb, and R. W. Heath, "Coverage and Capacity of millimeter-wave Cellular Networks," *IEEE Communications Magazine*, vol. 52, no. 9, pp. 70–77, 2014.
- [109] T. Bai and R. W. Heath, "Coverage and Rate Analysis for millimeter-wave Cellular Networks," *IEEE Transactions on Wireless Communications*, vol. 14, no. 2, pp. 1100–1114, 2014.
- [110] B. Yang, Z. Yu, J. Lan, R. Zhang, J. Zhou, and W. Hong, "Digital Beamforming-based Massive MIMO Transceiver for 5G millimeter-wave Communications," *IEEE Transactions on Microwave Theory and Techniques*, vol. 66, no. 7, pp. 3403–3418, 2018.
- [111] W. Roh, J.-Y. Seol, J. Park, B. Lee, J. Lee, Y. Kim, J. Cho, K. Cheun, and F. Aryanfar, "Millimeter-wave Beamforming as an Enabling Technology for 5G Cellular Communications: Theoretical Feasibility and Prototype Results," *IEEE communications magazine*, vol. 52, no. 2, pp. 106–113, 2014.
- [112] ITU, "IMT Vision – Framework and Overall Objectives of the Future Development of IMT for 2020 and Beyond," *ITU M Series: Mobile, Radiodetermination, Amateur and Related Satellite Services*, Rec. ITU-R M.2083, Sept. 2015.
- [113] H. Ji, S. Park, J. Yeo, Y. Kim, J. Lee, and B. Shim, "Ultra-Reliable and Low-Latency Communications in 5G Downlink: Physical Layer Aspects," *IEEE Wireless Communications*, vol. 25, no. 3, pp. 124–130, 2018.
- [114] N. A. Johansson, Y.-P. E. Wang, E. Eriksson, and M. Hessler, "Radio Access for Ultra-Reliable and Low-Latency 5G Communications," in *2015 IEEE International Conference on Communication Workshop (ICCW)*. IEEE, 2015, pp. 1184–1189.
- [115] P. Popovski, J. J. Nielsen, C. Stefanovic, E. De Carvalho, E. Strom, K. F. Trillingsgaard, A.-S. Bana, D. M. Kim, R. Kotaba, J. Park, et al., "Wireless Access for Ultra-Reliable Low-Latency Communication: Principles and Building Blocks," *Ieee Network*, vol. 32, no. 2, pp. 16–23, 2018.
- [116] 3GPP, "Study on New Radio Access Technology Physical Layer Aspects," Technical Report, Sep 2017. [Online]. Available: <https://portal.3gpp.org/desktopmodules/Specifications/SpecificationDetails.aspx?specificationId=3066>
- [117] M. Shafi, A. F. Molisch, P. J. Smith, T. Haustein, P. Zhu, P. Silva, F. Tufvesson, A. Benjebbour, and G. Wunder, "5G: A Tutorial Overview of Standards, Trials, Challenges, Deployment, and Practice," *IEEE Journal on Selected Areas in Communications*, vol. 35, no. 6, pp. 1201–1221, 2017.
- [118] NGMN Alliance, "Description of Network Slicing Concept," *NGMN 5G P*, vol. 1, 2016.
- [119] H. Zhang, N. Liu, X. Chu, K. Long, A.-H. Aghvami, and V. C. Leung, "Network Slicing based 5G and Future Mobile Networks: Mobility, Resource Management, and Challenges," *IEEE Communications Magazine*, vol. 55, no. 8, pp. 138–145, 2017.
- [120] M. Jaber, M. A. Imran, R. Tafazolli, and A. Tukmanov, "5G Backhaul Challenges and Emerging Research Directions: A Survey," *IEEE access*, vol. 4, pp. 1743–1766, 2016.
- [121] P.-H. Kuo and A. Mourad, "Millimeter Wave for 5G mobile Fronthaul and Backhaul," in *2017 European conference on networks and communications (EuCNC)*. IEEE, 2017, pp. 1–5.
- [122] 3GPP, "Study on New Radio Access Technology: Radio Access Architecture and Interfaces," Technical Report, Apr 2017. [Online]. Available: https://www.3gpp.org/ftp/Specs/archive/38_series/38.801/
- [123] ITU-T, "Technical Report GSTR-TN5G - Transport network support of IMT-2020/5G," Technical Report, 2018.
- [124] 5G Americas, "Innovations in 5G Backhaul Technologies: IAB, HFC & Fiber," June 2020. [Online]. Available: <https://www.5gamericas.org/wp-content/uploads/2020/06/Innovations-in-5G-Backhaul-Technologies-WP-PDF.pdf>
- [125] W. Feng, Y. Li, D. Jin, L. Su, and S. Chen, "Millimetre-Wave Backhaul for 5G Networks: Challenges and Solutions," *Sensors*, vol. 16, no. 6, p. 892, 2016.
- [126] C. Dehos, J. L. González, A. De Domenico, D. Ktenas, and L. Dussopt, "Millimeter-Wave Access and Backhauling: The Solution to the Exponential Data Traffic Increase in 5G Mobile Communications Systems?" *IEEE Communications Magazine*, vol. 52, no. 9, pp. 88–95, 2014.
- [127] M. Kamel, W. Hamouda, and A. Youssef, "Ultra-dense Networks: A Survey," *IEEE Communications Surveys & Tutorials*, vol. 18, no. 4, pp. 2522–2545, 2016.
- [128] R. Roman, J. Lopez, and M. Mambo, "Mobile Edge Computing, Fog et al.: A Survey and Analysis of Security Threats and Challenges," *Future Generation Computer Systems*, vol. 78, pp. 680–698, 2018.
- [129] P. Ranaweera, A. D. Jurcut, and M. Liyanage, "Realizing Multi-access Edge Computing Feasibility: Security Perspective," in *2019 IEEE Conference on Standards for Communications and Networking (CSCN)*. IEEE, 2019, pp. 1–7.
- [130] H. Guo, J. Liu, and J. Zhang, "Computation Offloading for Multi-access Mobile Edge Computing in Ultra-dense Networks," *IEEE Communications Magazine*, vol. 56, no. 8, pp. 14–19, 2018.
- [131] S. Kekki, W. Featherstone, Y. Fang, P. Kuure, A. Li, A. Ranjan, D. Purkayastha, F. Jiangping, D. Frydman, G. Verin, et al., "MEC in 5G Networks," *ETSI white paper*, vol. 28, pp. 1–28, 2018.
- [132] T. Driscoll, S. Farhoud, S. Nowling, et al., "Enabling Mobile Augmented and Virtual Reality with 5G Networks," Tech. rep. Tech. Rep, Tech. Rep., 2017.
- [133] NGMN, "5G White Paper," February 2015. [Online]. Available: https://www.ngmn.org/wp-content/uploads/NGMN_5G_White_Paper_V1_0_01.pdf
- [134] P. K. Agyapong, M. Iwamura, D. Staehle, W. Kiess, and A. Benjebbour, "Design Considerations for a 5G Network Architecture," *IEEE Communications Magazine*, vol. 52, no. 11, pp. 65–75, 2014.
- [135] E. Vlachos and A. S. Lalos, "Enabling Extended Reality Applications over 5G Mobile Networks," *ERCIM NEWS*, p. 30, 2019.
- [136] "Augmented Reality, ETSI." [Online]. Available: <https://www.etsi.org/technologies/augmented-reality>
- [137] 3GPP, "Technical Specification Group Services and System Aspects; Extended Reality (XR) in 5G," Technical Report, Dec 2020. [Online]. Available: https://www.3gpp.org/ftp/Specs/archive/26_series/26.928/
- [138] 3GPP, "Support of 5G Glass-type Augmented Reality / Mixed Reality (AR/MR) devices," Technical Report, Nov 2020. [Online]. Available: https://www.3gpp.org/ftp/Specs/archive/26_series/26.998/
- [139] A. Gurtov, M. Liyanage, and D. Korzun, "Secure Communication and Data Processing Challenges in the Industrial Internet," *Baltic Journal of Modern Computing*, vol. 4, no. 4, pp. 1058–1073, 2016.

- [140] A. Varghese and D. Tandur, "Wireless Requirements and Challenges in Industry 4.0," in *2014 International Conference on Contemporary Computing and Informatics (IC3I)*. IEEE, 2014, pp. 634–638.
- [141] S. K. Rao and R. Prasad, "Impact of 5G Technologies on Industry 4.0," *Wireless personal communications*, vol. 100, no. 1, pp. 145–159, 2018.
- [142] G. S. Gaba, G. Kumar, H. Monga, T.-H. Kim, M. Liyanage, and P. Kumar, "Robust and Lightweight Key Exchange (LKE) Protocol for Industry 4.0," *IEEE Access*, vol. 8, pp. 132 808–132 824, 2020.
- [143] J. Zhu, S. Ong, and A. Nee, "An Authorable Context-aware Augmented Reality System to assist the Maintenance Technicians," *The International Journal of Advanced Manufacturing Technology*, vol. 66, no. 9-12, pp. 1699–1714, 2013.
- [144] A. Martinetti, M. Rajabinejad, and L. van Dongen, "Shaping the Future Maintenance Operations: Reflections on the Adoptions of Augmented Reality through Problems and Opportunities," *Procedia CIRP*, vol. 59, pp. 14–17, 2017.
- [145] R. Masoni, F. Ferrise, M. Bordegoni, M. Gattullo, A. E. Uva, M. Fiorentino, E. Carrabba, and M. Di Donato, "Supporting Remote Maintenance in Industry 4.0 through Augmented Reality," *Procedia Manufacturing*, vol. 11, pp. 1296–1302, 2017.
- [146] D. Mourtzis, V. Zogopoulos, and E. Vlachou, "Augmented Reality Application to Support Remote Maintenance as a Service in the Robotics Industry," *Procedia CIRP*, vol. 63, pp. 46–51, 2017.
- [147] X. Wang, S. K. Ong, and A. Y. Nee, "A Comprehensive Survey of Augmented Reality Assembly Research," *Advances in Manufacturing*, vol. 4, no. 1, pp. 1–22, 2016.
- [148] J. Blattgerste, B. Streng, P. Renner, T. Pfeiffer, and K. Essig, "Comparing Conventional and Augmented Reality Instructions for Manual Assembly Tasks," in *Proceedings of the 10th International Conference on Pervasive Technologies Related to Assistive Environments*. ACM, 2017, pp. 75–82.
- [149] D. Tatić and B. Tešić, "The Application of Augmented Reality Technologies for the Improvement of Occupational Safety in an Industrial Environment," *Computers in Industry*, vol. 85, pp. 1–10, 2017.
- [150] J. Cheng, W. Chen, F. Tao, and C.-L. Lin, "Industrial iot in 5g environment towards smart manufacturing," *Journal of Industrial Information Integration*, vol. 10, pp. 10–19, 2018.
- [151] P. Porambage, J. Okwuibe, M. Liyanage, M. Ylianttila, and T. Taleb, "Survey on Multi-access Edge Computing for Internet of Things Realization," *IEEE Communications Surveys & Tutorials*, vol. 20, no. 4, pp. 2961–2991, 2018.
- [152] A. Reale, M. Tóth, and Z. Horváth, "Towards Context aware Computations Offloading in 5G," in *Proceedings of the 11th European Conference on Software Architecture: Companion Proceedings*, 2017, pp. 89–92.
- [153] P. S. Ranaweera, M. Liyanage, and A. D. Jurcut, "Novel MEC based Approaches for Smart Hospitals to Combat COVID-19 Pandemic," *IEEE Consumer Electronics Magazine*, 2020.
- [154] N. Navab, T. Blum, L. Wang, A. Okur, and T. Wendler, "First Deployments of Augmented Reality in Operating Rooms," *Computer*, vol. 45, no. 7, pp. 48–55, 2012.
- [155] F. Cutolo, M. Carbone, P. D. Parchi, V. Ferrari, M. Lisanti, and M. Ferrari, "Application of a New Wearable Augmented Reality Video See-through Display to Aid Percutaneous Procedures in Spine Surgery," in *International Conference on Augmented Reality, Virtual Reality and Computer Graphics*. Springer, 2016, pp. 43–54.
- [156] "Accuvein." [Online]. Available: <https://www.accuvein.com/why-accuvein/ar/>
- [157] E. Barsom, M. Graafland, and M. Schijven, "Systematic Review on the Effectiveness of Augmented Reality Applications in Medical Training," *Surgical endoscopy*, vol. 30, no. 10, pp. 4174–4183, 2016.
- [158] Y. A. Qadri, A. Nauman, Y. B. Zikria, A. V. Vasilakos, and S. W. Kim, "The Future of Healthcare Internet of Things: A Survey of Emerging Technologies," *IEEE Communications Surveys Tutorials*, vol. 22, no. 2, pp. 1121–1167, 2020.
- [159] Y. Lee and C. H. Lee, "Augmented Reality for Personalized Nanomedicines," *Biotechnology advances*, vol. 36, no. 1, pp. 335–343, 2018.
- [160] W. Tian, M. Fan, C. Zeng, Y. Liu, D. He, and Q. Zhang, "Telerobotic Spinal Surgery Based on 5G Network: The First 12 Cases," *Neurospine*, vol. 17, no. 1, p. 114, 2020.
- [161] Y. Siriwardhana, C. De Alwis, G. Gur, M. Ylianttila, and M. Liyanage, "The Fight against COVID-19 Pandemic with 5G Technologies," *IEEE Engineering Management Review*, 2020.
- [162] H. Magsi, A. H. Sodhro, F. A. Chachar, S. A. K. Abro, G. H. Sodhro, and S. Pirbhulal, "Evolution of 5G in Internet of Medical Things," in *2018 international conference on computing, mathematics and engineering technologies (iCoMET)*. IEEE, 2018, pp. 1–7.
- [163] "World's First Remote Surgery Over 5G;" January 2019. [Online]. Available: <https://www.independent.co.uk/life-style/gadgets-and-tech/news/5g-surgery-china-robotic-operation-a8732861.html>
- [164] P. Ranaweera, A. Jurcut, and M. Liyanage, "Novel MEC based Approaches for Smart Hospitals to Combat COVID-19 Pandemic," *IEEE Consumer Electronics Magazine*, 2020.
- [165] Y. Siriwardhana, G. Gur, M. Ylianttila, and M. Liyanage, "The Role of 5G for Digital Healthcare against COVID-19 Pandemic: Opportunities and Challenges," *Elsevier ICT Express*, 2020.
- [166] M. Ding, "Augmented Reality in Museums," *Museums & augmented reality—A collection of essays from the arts management and technology laboratory*, pp. 1–15, 2017.
- [167] S. Koo, J. Kim, C. Kim, J. Kim, and H. S. Cha, "Development of an Augmented Reality Tour Guide for a Cultural Heritage Site," *Journal on Computing and Cultural Heritage (JOCCH)*, vol. 12, no. 4, pp. 1–24, 2019.
- [168] "Tunnel Vision." [Online]. Available: <http://www.tunnelvisionapp.com/>
- [169] "kabaq." [Online]. Available: <https://www.kabaq.io/>
- [170] "Bone Hall." [Online]. Available: <https://naturalhistory.si.edu/exhibits/bone-hall>
- [171] "AR & VR at Best Western Plus Kelowna Hotel & Suites." [Online]. Available: <https://www.youtube.com/watch?v=u6pA4sVVJv0>
- [172] X. Ba and Y. Wang, "Load-aware Cell Select Scheme for Multi-connectivity in Intra-frequency 5G Ultra Dense Network," *IEEE Communications Letters*, vol. 23, no. 2, pp. 354–357, 2019.
- [173] L. Z. W. Tang, K. S. Ang, M. Amirul, M. B. M. Yusoff, C. K. Tng, M. D. B. M. Alyas, J. G. Lim, P. K. Kyaw, and F. Foliato, "Augmented Reality Control Home (ARCH) for Disabled and Elderlies," in *2015 IEEE Tenth international conference on intelligent sensors, sensor networks and information processing (ISSNIP)*. IEEE, 2015, pp. 1–2.
- [174] A. M. Ullah, M. R. Islam, S. F. Aktar, and S. A. Hossain, "Remote-Touch: Augmented Reality based Marker Tracking for Smart Home Control," in *2012 15th International conference on computer and information technology (ICCI)*. IEEE, 2012, pp. 473–477.
- [175] Z. Rashid, J. Melià-Seguí, R. Pous, and E. Peig, "Using Augmented Reality and Internet of Things to Improve Accessibility of People with Motor Disabilities in the context of Smart Cities," *Future Generation Computer Systems*, vol. 76, pp. 248–261, 2017.
- [176] M. Aftab, S. C.-K. Chau, and M. Khonji, "Enabling Self-aware Smart Buildings by Augmented Reality," in *Proceedings of the Ninth International Conference on Future Energy Systems*. ACM, 2018, pp. 261–265.
- [177] L. R. Suzuki, K. Brown, S. Pipes, and J. Ibbotson, "Smart Building Management through Augmented Reality," in *2014 IEEE International Conference on Pervasive Computing and Communication Workshops (PERCOM WORKSHOPS)*. IEEE, 2014, pp. 105–110.
- [178] P. Verma and S. K. Sood, "Fog Assisted-IoT Enabled Patient Health Monitoring in Smart Homes," *IEEE Internet of Things Journal*, vol. 5, no. 3, pp. 1789–1796, 2018.
- [179] S. K. Rao and R. Prasad, "Impact of 5G technologies on Smart city Implementation," *Wireless Personal Communications*, vol. 100, no. 1, pp. 161–176, 2018.
- [180] J. M. Khurpade, D. Rao, and P. D. Sanghavi, "A Survey on IOT and 5G Network," in *2018 International Conference on Smart City and Emerging Technology (ICSCET)*. IEEE, 2018, pp. 1–3.
- [181] "Smart AR Home." [Online]. Available: <http://smarthome.com/>
- [182] F. Ramos, S. Trilles, J. Torres-Sospedra, and F. J. Perales, "New Trends in using Augmented Reality Apps for Smart City Contexts," *ISPRS International Journal of Geo-Information*, vol. 7, no. 12, p. 478, 2018.
- [183] H. Pang, J. Liu, X. Fan, and L. Sun, "Toward Smart and Cooperative Edge Caching for 5G Networks: A Deep Learning based Approach," in *2018 IEEE/ACM 26th International Symposium on Quality of Service (IWQoS)*. IEEE, 2018, pp. 1–6.
- [184] L. Abdi, F. B. Abdallah, and A. Meddeb, "In-vehicle Augmented Reality Traffic Information System: A New Type of Communication between Driver and Vehicle," *Procedia Computer Science*, vol. 73, pp. 242–249, 2015.
- [185] H. Li and F. Nashashibi, "Multi-vehicle Cooperative Perception and Augmented Reality for Driver Assistance: A Possibility to See-through front Vehicle," in *2011 14th International IEEE Conference on Intelligent Transportation Systems (ITSC)*. IEEE, 2011, pp. 242–247.
- [186] D. Sportillo, A. Paljic, and L. Ojeda, "On-road Evaluation of Autonomous Driving Training," in *2019 14th ACM/IEEE International Conference on Human-Robot Interaction (HRI)*. IEEE, 2019, pp. 182–190.

- [187] S. Nolle and G. Klinker, "Augmented Reality as a Comparison Tool in Automotive Industry," in *2006 IEEE/ACM International Symposium on Mixed and Augmented Reality*. IEEE, 2006, pp. 249–250.
- [188] "Mercedes-Benz Digital Lights." [Online]. Available: <https://www.youtube.com/watch?v=xe66enKPLHk&fbclid=IwAR266QiE70sw8vZBbZoCt-lvuSIJtGPhvYbvCVK2-ZvIj2zKnmpXHbK79k>
- [189] S. A. A. Shah, E. Ahmed, M. Imran, and S. Zeadally, "5G for Vehicular Communications," *IEEE Communications Magazine*, vol. 56, no. 1, pp. 111–117, 2018.
- [190] R. Yu, J. Ding, X. Huang, M.-T. Zhou, S. Gjessing, and Y. Zhang, "Optimal Resource Sharing in 5G-enabled Vehicular Networks: A Matrix Game Approach," *IEEE Transactions on Vehicular Technology*, vol. 65, no. 10, pp. 7844–7856, 2016.
- [191] J. Greenhalgh and M. Mirmehdi, "Recognizing Text-based Traffic Signs," *IEEE Transactions on Intelligent Transportation Systems*, vol. 16, no. 3, pp. 1360–1369, 2014.
- [192] J. L. Gabbard, M. Smith, K. Tanous, H. Kim, and B. Jonas, "AR DriveSim: An Immersive Driving Simulator for Augmented Reality Head-up Display Research," *Frontiers in Robotics and AI*, vol. 6, p. 98, 2019.
- [193] H. Regenbrecht, G. Baratoff, and W. Wilke, "Augmented Reality Projects in the Automotive and Aerospace Industries," *IEEE computer graphics and applications*, vol. 25, no. 6, pp. 48–56, 2005.
- [194] H. Eschen, T. Kötter, R. Rodeck, M. Harnisch, and T. Schüppstuhl, "Augmented and Virtual Reality for Inspection and Maintenance Processes in the Aviation Industry," *Procedia manufacturing*, vol. 19, pp. 156–163, 2018.
- [195] F. De Crescenzo, M. Fantini, F. Persiani, L. Di Stefano, P. Azzari, and S. Salti, "Augmented Reality for Aircraft Maintenance Training and Operations Support," *IEEE Computer Graphics and Applications*, vol. 31, no. 1, pp. 96–101, 2010.
- [196] "MAR at Airports." [Online]. Available: <https://www.youtube.com/watch?v=5OHd0xGC87M>
- [197] H. Wan, S. Zou, Z. Dong, H. Lin, and H. Bao, "MRStudio: A Mixed Reality Display System for Aircraft Cockpit," in *2011 IEEE International Symposium on VR Innovation*. IEEE, 2011, pp. 129–135.
- [198] "MAR for Cabin Crew." [Online]. Available: <https://www.youtube.com/watch?v=zD1bsl3AEeI>
- [199] B. Bogdandy, J. Tamas, and Z. Toth, "Digital Transformation in Education during COVID-19: a Case Study," in *2020 11th IEEE International Conference on Cognitive Infocommunications (CogInfoCom)*. IEEE, 2020, pp. 000 173–000 178.
- [200] P. Chen, X. Liu, W. Cheng, and R. Huang, "A Review of using Augmented Reality in Education from 2011 to 2016," in *Innovations in smart learning*. Springer, 2017, pp. 13–18.
- [201] M. Zikky, K. Fathoni, and M. Firdaus, "Interactive Distance Media Learning Collaborative based on Virtual Reality with Solar System Subject," in *2018 19th IEEE/ACIS International Conference on Software Engineering, Artificial Intelligence, Networking and Parallel/Distributed Computing (SNPD)*. IEEE, 2018, pp. 4–9.
- [202] A. Baratè, G. Haus, L. A. Ludovico, E. Pagani, and N. Scarabottolo, "5G Technology for Augmented and Virtual Reality in Education," in *Proceedings of the International Conference on Education and New Developments 2019 (END 2019)*, 2019, pp. 512–516.
- [203] G. S. Von Itzstein, M. Billingham, R. T. Smith, and B. H. Thomas, "Augmented Reality Entertainment: Taking Gaming Out of the Box," 2019.
- [204] T. A. Sitompul and M. Wallmyr, "Using Augmented Reality to Improve Productivity and Safety for Heavy Machinery Operators: State of the Art," in *The 17th International Conference on Virtual-Reality Continuum and Its Applications in Industry*, 2019, pp. 1–9.
- [205] R. Boardman, C. E. Henninger, and A. Zhu, "Augmented Reality and Virtual Reality: New Drivers for Fashion Retail?" in *Technology-Driven Sustainability*. Springer, 2020, pp. 155–172.
- [206] Y.-g. Kim and W.-j. Kim, "Implementation of Augmented Reality System for Smartphone Advertisements," *international journal of multimedia and ubiquitous engineering*, vol. 9, no. 2, pp. 385–392, 2014.
- [207] ImmersiveTouch, "Comprehensive Surgical Training using the power of Augmented and Virtual Reality," 2020. [Online]. Available: <https://www.immersivetouch.com/immersivesim-training>
- [208] L3HARRIS, "Blue Boxer Extended Reality (BBXR) Training System," 2020. [Online]. Available: https://www.l3t.com/link/assets/uploads/pdf/datasheets/L3Harris_Collateral_BBXR_SellSheet_0719.pdf
- [209] "AR Based Drone Pilot Training." [Online]. Available: <https://dronoss.com/>
- [210] J.-M. Chung, Y.-S. Park, J.-H. Park, and H. Cho, "Adaptive Cloud Offloading of Augmented Reality Applications on Smart Devices for Minimum Energy Consumption," *KSI Transactions on Internet & Information Systems*, vol. 9, no. 8, 2015.
- [211] M. Giordani, M. Mezzavilla, and M. Zorzi, "Initial Access in 5G mmWave Cellular Networks," *IEEE Communications Magazine*, vol. 54, no. 11, pp. 40–47, 2016.
- [212] R. Ford, M. Zhang, M. Mezzavilla, S. Dutta, S. Rangan, and M. Zorzi, "Achieving Ultra-low Latency in 5G Millimeter Wave Cellular Networks," *IEEE Communications Magazine*, vol. 55, no. 3, pp. 196–203, 2017.
- [213] Y. Xiao, J. Zhang, Z. Gao, and Y. Ji, "Service-oriented DU-CU Placement Using Reinforcement Learning in 5G/B5G Converged Wireless-Optical Networks," in *Optical Fiber Communication Conference*. Optical Society of America, 2020, pp. T4D–5.
- [214] M. Lauridsen, L. C. Gimenez, I. Rodriguez, T. B. Sorensen, and P. Mogensen, "From LTE to 5G for Connected Mobility," *IEEE Communications Magazine*, vol. 55, no. 3, pp. 156–162, 2017.
- [215] M. Polese, M. Giordani, M. Mezzavilla, S. Rangan, and M. Zorzi, "Improved Handover through Dual Connectivity in 5G mmWave Mobile Networks," *IEEE Journal on Selected Areas in Communications*, vol. 35, no. 9, pp. 2069–2084, 2017.
- [216] M. Tayyab, X. Gelabert, and R. Jäntti, "A Survey on Handover Management: From LTE to NR," *IEEE Access*, vol. 7, pp. 118907–118930, 2019.
- [217] M. De Sá and E. F. Churchill, "Mobile Augmented Reality: A Design Perspective," in *Human factors in augmented reality environments*. Springer, 2013, pp. 139–164.
- [218] C. Yoon, D. Kim, W. Jung, C. Kang, and H. Cha, "Appscope: Application Energy Metering Framework for Android Smartphone using Kernel Activity Monitoring," in *Presented as part of the 2012 {USENIX} Annual Technical Conference ({USENIX}{ATC} 12)*, 2012, pp. 387–400.
- [219] S. Song, J. Kim, and J.-M. Chung, "Energy Consumption Minimization Control for Augmented Reality Applications based on Multi-core Smart Devices," in *2019 IEEE International Conference on Consumer Electronics (ICCE)*. IEEE, 2019, pp. 1–4.
- [220] K. Kumar, J. Liu, Y.-H. Lu, and B. Bhargava, "A Survey of Computation Offloading for Mobile Systems," *Mobile networks and Applications*, vol. 18, no. 1, pp. 129–140, 2013.
- [221] J. Park, H. Seong, Y. N. Whang, and W. Hong, "Energy-efficient 5G Phased Arrays Incorporating Vertically Polarized Endfire Planar Folded Slot Antenna for mmwave Mobile Terminals," *IEEE Transactions on Antennas and Propagation*, vol. 68, no. 1, pp. 230–241, 2019.
- [222] J. Huang, F. Qian, A. Gerber, Z. M. Mao, S. Sen, and O. Spatscheck, "A Close Examination of Performance and Power Characteristics of 4G LTE Networks," in *Proceedings of the 10th international conference on Mobile systems, applications, and services*, 2012, pp. 225–238.
- [223] F. Guo, H. Zhang, H. Ji, X. Li, and V. C. Leung, "Energy Efficient Computation Offloading for Multi-access MEC enabled Small Cell Networks," in *2018 IEEE International Conference on Communications Workshops (ICC Workshops)*. IEEE, 2018, pp. 1–6.
- [224] K. Zhang, Y. Mao, S. Leng, Q. Zhao, L. Li, X. Peng, L. Pan, S. Maharjan, and Y. Zhang, "Energy-efficient offloading for mobile edge computing in 5g heterogeneous networks," *IEEE access*, vol. 4, pp. 5896–5907, 2016.
- [225] T. Braud, P. Zhou, J. Kangasharju, and P. Hui, "Multipath Computation Offloading for Mobile Augmented Reality," in *In Proceedings of the IEEE International Conference on Pervasive Computing and Communications (PerCom 2020), Austin USA*, 2020.
- [226] M. Giordani, M. Mezzavilla, S. Rangan, and M. Zorzi, "Multi-connectivity in 5G mmWave Cellular Networks," in *2016 Mediterranean Ad Hoc Networking Workshop (Med-Hoc-Net)*. IEEE, 2016, pp. 1–7.
- [227] S. Muruganathan, S. Faxer, S. Jarmyr, S. Gao, and M. Frenne, "On the System-level Performance of Coordinated Multi-point Transmission Schemes in 5G NR Deployment Scenarios," in *2019 IEEE 90th Vehicular Technology Conference (VTC2019-Fall)*. IEEE, 2019, pp. 1–5.
- [228] X. Xu, X. Zhang, X. Liu, J. Jiang, L. Qi, and M. Z. A. Bhuiyan, "Adaptive Computation Offloading With Edge for 5G-Envisioned Internet of Connected Vehicles," *IEEE Transactions on Intelligent Transportation Systems*, pp. 1–10, 2020.
- [229] S. Wang, J. Xu, N. Zhang, and Y. Liu, "A Survey on Service Migration in Mobile Edge Computing," *IEEE Access*, vol. 6, pp. 23 511–23 528, 2018.

- [230] V. Sharma, D. N. K. Jayakody, and M. Qaraqe, "Osmotic Computing-based Service Migration and Resource Scheduling in Mobile Augmented Reality Networks (MARN)," *Future Generation Computer Systems*, vol. 102, pp. 723–737, 2020.
- [231] R. Urgaonkar, S. Wang, T. He, M. Zafer, K. Chan, and K. K. Leung, "Dynamic Service Migration and Workload Scheduling in Edge-clouds," *Performance Evaluation*, vol. 91, pp. 205–228, 2015.
- [232] A. Machen, S. Wang, K. K. Leung, B. J. Ko, and T. Salonidis, "Live Service Migration in Mobile Edge Clouds," *IEEE Wireless Communications*, vol. 25, no. 1, pp. 140–147, 2017.
- [233] A. Aissioui, A. Ksentini, A. M. Gueroui, and T. Taleb, "On Enabling 5G Automotive Systems using Follow Me Edge-cloud Concept," *IEEE Transactions on Vehicular Technology*, vol. 67, no. 6, pp. 5302–5316, 2018.
- [234] T. Ouyang, Z. Zhou, and X. Chen, "Follow Me at the Edge: Mobility-aware Dynamic Service Placement for Mobile Edge Computing," *IEEE Journal on Selected Areas in Communications*, vol. 36, no. 10, pp. 2333–2345, 2018.
- [235] A. Braeken, P. Porambage, A. Puvaneswaran, and M. Liyanage, "ES-SMAR: Edge Supportive Secure Mobile Augmented Reality Architecture for Healthcare," in *The 5th International Conference on Cloud Computing and Artificial Intelligence: Technologies and Applications (CloudTech 2020)*. IEEE, 2020.
- [236] F. Roesner, T. Kohno, and D. Molnar, "Security and Privacy for Augmented Reality Systems," *Commun. ACM*, vol. 57, no. 4, pp. 88–96, 2014.
- [237] S. Baldassi, T. Kohno, F. Roesner, and M. Tian, "Challenges and New Directions in Augmented Reality, Computer Security, and Neuroscience—Part 1: Risks to Sensation and Perception," *arXiv preprint arXiv:1806.10557*, 2018.
- [238] J. A. De Guzman, K. Thilakarathna, and A. Seneviratne, "Security and Privacy Approaches in Mixed Reality: A Literature Survey," *ACM Computing Surveys (CSUR)*, vol. 52, no. 6, p. 110, 2019.
- [239] D. Sattar and A. Matrawy, "Towards Secure Slicing: Using Slice Isolation to Mitigate DDoS Attacks on 5G Core Network Slices," in *2019 IEEE Conference on Communications and Network Security (CNS)*. IEEE, 2019, pp. 82–90.
- [240] P. Ranaweera, V. N. Imrith, M. Liyanage, and A. D. Jurcut, "Security as a Service Platform Leveraging Multi-Access Edge Computing Infrastructure Provisions," in *ICC 2020-2020 IEEE International Conference on Communications (ICC)*. IEEE, 2020, pp. 1–6.
- [241] I. Ahmad, T. Kumar, M. Liyanage, J. Okwuibe, M. Ylianttila, and A. Gurtov, "Overview of 5G Security Challenges and Solutions," *IEEE Communications Standards Magazine*, vol. 2, no. 1, pp. 36–43, 2018.
- [242] K. Lebeck, K. Ruth, T. Kohno, and F. Roesner, "Towards Security and Privacy for Multi-User Augmented Reality: Foundations with End Users," in *2018 IEEE Symposium on Security and Privacy (SP)*. IEEE, 2018, pp. 392–408.
- [243] M. Liyanage, J. Salo, A. Braeken, T. Kumar, S. Seneviratne, and M. Ylianttila, "5G privacy: Scenarios and Solutions," in *2018 IEEE 5G World Forum (5GWF)*. IEEE, 2018, pp. 197–203.
- [244] N. Shaikh, M. Krishnan, and G. Gulawani, "Enhancing Privacy and Security on a SDN Network using SDN Flow based Forwarding Control," Apr. 17 2018, uS Patent 9,948,606.
- [245] X. Duan and X. Wang, "Authentication Handover and Privacy Protection in 5G Hetnets using Software-defined Networking," *IEEE Communications Magazine*, vol. 53, no. 4, pp. 28–35, 2015.
- [246] A. Y. Nee, S. Ong, G. Chrysolouris, and D. Mourtzis, "Augmented Reality Applications in Design and Manufacturing," *CIRP annals*, vol. 61, no. 2, pp. 657–679, 2012.
- [247] H. A. Alhajja, S. K. Mustikovela, L. Mescheder, A. Geiger, and C. Rother, "Augmented Reality meets Computer Vision: Efficient Data Generation for Urban Driving Scenes," *International Journal of Computer Vision*, vol. 126, no. 9, pp. 961–972, 2018.
- [248] M. Alonso-Rosa, A. Gil-de Castro, A. Moreno-Munoz, J. Garrido-Zafra, E. Gutierrez-Ballesteros, and E. Cañete-Carmona, "An IoT Based Mobile Augmented Reality Application for Energy Visualization in Buildings Environments," *Applied Sciences*, vol. 10, no. 2, p. 600, 2020.
- [249] C. Wang, S. Zhang, Z. Qian, M. Xiao, J. Wu, B. Ye, and S. Lu, "Joint Server Assignment and Resource Management for Edge-Based MAR System," *IEEE/ACM Transactions on Networking*, 2020.
- [250] A. Younis, B. Qiu, and D. Pompili, "Latency-aware Hybrid Edge Cloud Framework for Mobile Augmented Reality Applications," in *2020 17th Annual IEEE International Conference on Sensing, Communication, and Networking (SECON)*, 2020, pp. 1–9.
- [251] Y. Siriwardhana, P. Porambage, M. Ylianttila, and M. Liyanage, "Performance Analysis of Local 5G Operator Architectures for Industrial Internet," *IEEE Internet of Things Journal*, pp. 1–1, 2020.
- [252] F. Giust, L. Cominardi, and C. J. Bernardos, "Distributed Mobility Management for Future 5G Networks: Overview and Analysis of Existing Approaches," *IEEE Communications Magazine*, vol. 53, no. 1, pp. 142–149, 2015.
- [253] D. Battulga, J. Ankhzaya, B. Ankhbayar, U. Ganbayar, and S. Sodbileg, "Handover Management for Distributed Mobility Management in SDN-based Mobile Networks," in *2017 27th International Telecommunication Networks and Applications Conference (ITNAC)*. IEEE, 2017, pp. 1–6.
- [254] Y. Mao, J. Zhang, and K. B. Letaief, "Dynamic computation offloading for mobile-edge computing with energy harvesting devices," *IEEE Journal on Selected Areas in Communications*, vol. 34, no. 12, pp. 3590–3605, 2016.
- [255] "WiTricity." [Online]. Available: <https://witricity.com/technology/>
- [256] H. Kim and K. Chung, "Design of Adaptive Offloading Framework for Video Streaming over 5G NR with Multipath TCP," in *2019 IEEE 8th Global Conference on Consumer Electronics (GCCE)*. IEEE, 2019, pp. 727–728.
- [257] H. Lin, X. Xu, J. Zhao, and X. Wang, "Dynamic Service Migration in Ultra-Dense Multi-Access Edge Computing network for High Mobility Scenarios," *EURASIP Journal on Wireless Communications and Networking*, 2020.
- [258] T. Hewa, M. Ylianttila, and M. Liyanage, "Survey on Blockchain based Smart Contracts: Applications, Opportunities and Challenges," *Journal of Network and Computer Applications*, p. 102857, 2020.
- [259] S. Ahn, M. Gorlatova, P. Naghizadeh, M. Chiang, and P. Mittal, "Adaptive Fog-based Output Security for Augmented Reality," in *Proceedings of the 2018 Morning Workshop on Virtual Reality and Augmented Reality Network*. ACM, 2018, pp. 1–6.
- [260] M. Langfinger, M. Schneider, D. Stricker, and H. D. Schotten, "Addressing Security Challenges in Industrial Augmented Reality Systems," in *2017 IEEE 15th International Conference on Industrial Informatics (INDIN)*. IEEE, 2017, pp. 299–304.
- [261] M. Villari, M. Fazio, S. Dustdar, O. Rana, and R. Ranjan, "Osmotic Computing: A New Paradigm for Edge/cloud Integration," *IEEE Cloud Computing*, vol. 3, no. 6, pp. 76–83, 2016.
- [262] ETSI, "Zero touch Network and Service Management." [Online]. Available: <https://www.etsi.org/technologies/zero-touch-network-service-management>
- [263] M. Liyanage, A. Braeken, P. Kumar, and M. Ylianttila, *IoT Security: Advances in Authentication*. John Wiley & Sons, 2020.
- [264] A. Varghese, N. Narendra, M. Singh, S. V. R. Ma, M. G. Chandra, and P. Balamuralidhar, "Smart: Secure Mobile Augmented Reality for Tele-Assistance," in *2015 Asia Pacific Conference on Multimedia and Broadcasting*. IEEE, 2015, pp. 1–7.
- [265] F.-Y. Rao and E. Bertino, "Privacy Techniques for Edge Computing Systems," *Proceedings of the IEEE*, vol. 107, no. 8, pp. 1632–1654, 2019.
- [266] Z. Lin, X. Du, H.-H. Chen, B. Ai, Z. Chen, and D. Wu, "Millimeter-wave Propagation Modeling and Measurements for 5G Mobile Networks," *IEEE Wireless Communications*, vol. 26, no. 1, pp. 72–77, 2019.
- [267] K. Khaled and L. Talbi, "Case Study of Radio Coverage in Complex Indoor Environments for 5G Communications," in *2019 IEEE International Conference on Wireless for Space and Extreme Environments (WiSEE)*, 2019, pp. 105–110.
- [268] V. Petrov, M. Gapeyenko, D. Moltchanov, A. Samuylov, S. Andreev, and Y. Koucheryavy, "Effects of Dynamic Blockage in Multi-Connectivity Millimeter-Wave Radio Access," *5G Verticals: Customizing Applications, Technologies and Deployment Techniques*, pp. 93–117, 2020.
- [269] G. Nigam, P. Minero, and M. Haenggi, "Coordinated Multipoint Joint Transmission in Heterogeneous Networks," *IEEE Transactions on Communications*, vol. 62, no. 11, pp. 4134–4146, 2014.
- [270] J. Khan and L. Jacob, "Learning Based CoMP Clustering for URLLC in Millimeter wave 5G networks with Blockages," in *2019 IEEE International Conference on Advanced Networks and Telecommunications Systems (ANTS)*, 2019, pp. 1–6.
- [271] D. Korpi, P. Yli-Opas, M. R. Jaramillo, and M. A. Uusitalo, "Visual Detection-based Blockage Prediction for beyond 5G Wireless Systems," in *2020 2nd 6G Wireless Summit (6G SUMMIT)*. IEEE, 2020, pp. 1–5.
- [272] A. Shahmansoori, B. Uguen, G. Destino, G. Seco-Granados, and H. Wymeersch, "Tracking Position and Orientation through Millimeter

- Wave Lens MIMO in 5G Systems,” *IEEE Signal Processing Letters*, vol. 26, no. 8, pp. 1222–1226, 2019.
- [273] C. Fiandrino, H. Assasa, P. Casari, and J. Widmer, “Scaling Millimeter-wave Networks to Dense Deployments and Dynamic Environments,” *Proceedings of the IEEE*, vol. 107, no. 4, pp. 732–745, 2019.
- [274] Y. Siriwardhana, P. Porambage, M. Liyanage, J. S. Walia, M. Matinmikko-Blue, and M. Ylianttila, “Micro-operator driven Local 5G Network Architecture for Industrial Internet,” in *2019 IEEE Wireless Communications and Networking Conference (WCNC)*. IEEE, 2019, pp. 1–8.
- [275] Y. Siriwardhana, P. Porambage, M. Ylianttila, and M. Liyanage, “Performance Analysis of Local 5G Operator Architectures for Industrial Internet,” *IEEE Internet of Things Journal*, vol. 7, no. 12, pp. 11 559–11 575, 2020.
- [276] H. Kim, J. Kim, and D. Hong, “Dynamic TDD Systems for 5G and Beyond: A Survey of Cross-link Interference Mitigation,” *IEEE Communications Surveys & Tutorials*, pp. 1–1, 2020.
- [277] T. Taleb, B. Mada, M.-I. Corici, A. Nakao, and H. Flinck, “PERMIT: Network Slicing for Personalized 5G Mobile Telecommunications,” *IEEE Communications Magazine*, vol. 55, no. 5, pp. 88–93, 2017.
- [278] H. Wang, Y. Wu, G. Min, J. Xu, and P. Tang, “Data-driven Dynamic Resource Scheduling for Network Slicing: A Deep Reinforcement Learning Approach,” *Information Sciences*, vol. 498, pp. 106–116, 2019.
- [279] S. N. Ali, P. Agarwal, J. Baylon, S. Gopal, L. Renaud, and D. Heo, “A 28GHz 41%-PAE Linear CMOS Power Amplifier using a Transformer-based AM-PM Distortion-correction Technique for 5G Phased Arrays,” in *2018 IEEE International Solid-State Circuits Conference-(ISSCC)*. IEEE, 2018, pp. 406–408.
- [280] “Heterogeneous III-V/CMOS Technologies for beyond-5G RF Front-end Modules.” [Online]. Available: <https://www.imec-int.com/en/imec-magazine/imec-reading-room-january-2020/heterogeneous-iii-v-cmos-technologies-for-beyond-5g-rf-front-end-modules>
- [281] P. Choi, D. A. Antoniadis, and E. A. Fitzgerald, “Towards Millimeter-Wave Phased Array Circuits and Systems For Small Form Factor and Power Efficient 5G Mobile Devices,” in *2019 IEEE International Symposium on Phased Array System Technology (PAST)*, 2019, pp. 1–5.
- [282] R. Shafin, L. Liu, V. Chandrasekhar, H. Chen, J. Reed, and J. C. Zhang, “Artificial Intelligence-Enabled Cellular Networks: A Critical Path to Beyond-5G and 6G,” *IEEE Wireless Communications*, vol. 27, no. 2, pp. 212–217, 2020.
- [283] Y. Liu, M. Peng, G. Shou, Y. Chen, and S. Chen, “Toward Edge Intelligence: Multiaccess Edge Computing for 5G and Internet of Things,” *IEEE Internet of Things Journal*, vol. 7, no. 8, pp. 6722–6747, 2020.
- [284] Y. Shi, K. Yang, T. Jiang, J. Zhang, and K. B. Letaief, “Communication-Efficient Edge AI: Algorithms and Systems,” *IEEE Communications Surveys Tutorials*, vol. 22, no. 4, pp. 2167–2191, 2020.



Yushan Siriwardhana is currently a Doctoral degree student in the Centre for Wireless Communications, University of Oulu, Finland. He received the bachelor’s degree in electronics and telecommunication engineering from the University of Moratuwa, Sri Lanka, in 2009 and the master’s degree in wireless communication engineering from the University of Oulu, Finland, in 2019. He has over 7 years experience in telecommunication industry. His research interests include 5G, Local 5G and future networks, Security in IoT, MEC.



Wireless Sensor Networks.

Pawani Porambage Pawani Porambage is a post-doctoral researcher at the Centre for Wireless Communications, University of Oulu, Finland. She received her doctoral degree on Communications Engineering from University of Oulu, Finland in 2018. She obtained MSc and BSc degrees respectively from University of Nice Sophia-Anipolis, France (2012) and University of Moratuwa, Sri Lanka (2010). Her main research interests include lightweight security protocols, blockchain, security and privacy on IoT and MEC, Network Slicing and



Madhusanka Liyanage (M.Eng, M. Sc, Dr.Sc) is currently an assistant professor/ad astra fellow at University College Dublin, Ireland and an adjunct professor at the University of Oulu, Finland. He received his B.Sc. degree (First Class Honours) in electronics and telecommunication engineering from the University of Moratuwa, Moratuwa, Sri Lanka, in 2009, the M.Eng. degree from the Asian Institute of Technology, Bangkok, Thailand, in 2011, the M.Sc. degree from the University of Nice Sophia Antipolis, Nice, France, in 2011, and the Doctor of Technology degree in communication engineering from the University of Oulu, Oulu, Finland, in 2016. From 2011 to 2012, he worked a Research Scientist at the I3S Laboratory and Inria, Sophia Antipolis, France. He was also a recipient of prestigious Marie Skłodowska-Curie Actions Individual Fellowship during 2018-2020. During 2015-2018, he has been a Visiting Research Fellow at the CSIRO, Australia, the Infolabs21, Lancaster University, U.K., Computer Science and Engineering, The University of New South Wales, Australia, School of IT, University of Sydney, Australia, LIP6, Sorbonne University, France and Computer Science and Engineering, The University of Oxford, U.K. He is also a senior member of IEEE. In 2020, he has received “2020 IEEE ComSoc Outstanding Young Researcher” award by IEEE ComSoc EMEA.

He has co-authored over 100 publications including three edited books with Wiley and one patent. Moreover, He has received two best Paper Awards in the areas of SDMN security (at NGMAST 2015) and 5G Security (at IEEE CSCN 2017). Additionally, he has been awarded two research grants and 19 other prestigious awards/scholarships during his research career. Liyanage has worked for more than twelve EU, international and national projects in ICT domain. He held responsibilities as a leader of work packages in several projects including SIGMONA and Naked approach projects. Currently, he is the Finnish national coordinator for EU COST Action CA15127 on resilient communication services and also serving as management committee member for three other EU COST action projects namely EU COST Action IC1301, IC1303, CA15107 and CA16226. Liyanage has over seven years’ experience in research project management, research group leadership, research project proposal preparation, project progress documentation and graduate student co-supervision/mentoring, skills. For last four years, 2015, 2016, 2017 and 2018, he won the Best Researcher Award at the Centre for Wireless Communications, University of Oulu for his excellent contribution in project management and project proposal preparation. In 2020, he was selected as the best researcher at School of Computer Science, University College Dublin, Ireland. Additionally, two of the research projects (MEVICO and SIGMONA projects) received the CELTIC Excellence and CELTIC Innovation Awards in 2013, 2017 and 2018 respectively.

Dr. Liyanage’s research interests are 5G, SDN, IoT, Blockchain, MEC, mobile and virtual network security. More Info: <http://madhusanka.com>



Mika Ylianttila (M. Sc, Dr.Sc, eMBA) is a full-time associate professor (tenure track) at the Centre for Wireless Communications (CWC), at the Faculty of Information Technology and Electrical Engineering (ITEE), University of Oulu, Finland. He is leading a research team and is the director of communications engineering doctoral degree program. Previously he was the director of Center for Internet Excellence (2012-2015), vice director of MediaTeam Oulu research group (2009-2011), and professor (pro tem) in computer science and engineering, and director of information networks study programme (2005-2010). He received his doctoral degree on Communications Engineering at the University of Oulu in 2005. He has coauthored more than 150 international peer-reviewed articles. His research interests include edge computing, network security, network virtualization and software-defined networking. He is a Senior Member of IEEE, and Editor in *Wireless Networks* journal.

Mika Ylianttila's research interests are Wireless Communications and Communications Technology, 5G, Wireless Technologies and Applications of the Wireless Internet, and Software Defined Networking.