

Possibilistic-Scenario Model for DG Impact Assessment on Distribution Networks in an Uncertain Environment

Alireza Soroudi

Abstract—The Distribution Network Operators (DNOs) are responsible for securing a diverse and viable energy supply for their customers so the technical and economical impacts of distributed generation (DG) units are of great concerns. Traditionally, the DNOs try to maximize the technical performance of the distribution network but it is evident that the first step in optimizing a quantity is being able to calculate it. The DG investment/operation which is performed by Distributed Generation Operators/Owners (DGOs) (under unbundling rules) has made this task more complicated. This is mainly because the DNO is faced with the uncertainties related to the decisions of DG investors/operators where some of them can be probabilistically modeled while the others are possibilistically treated. This paper proposes a hybrid possibilistic-probabilistic DG impact assessment tool which takes into account the uncertainties associated with investment and operation of renewable and conventional DG units on distribution networks. This tool would be useful for DNOs to deal with the uncertainties which some of them can be modeled probabilistically and some of them are described possibilistically. The proposed method has been tested on a test system and also a large scale real distribution network to demonstrate its strength and flexibility.

Index Terms—Distributed generation, Fuzzy sets, Stochastic approximation, Uncertainty, Risk analysis, Wind energy.

NOMENCLATURE

$\tilde{P}_{i,t}^D, \tilde{Q}_{i,t}^D$	Active and reactive power demand in bus i and year t
$\tilde{S}_{t,s}^{grid}$	Apparent power imported from grid in year t and state s
$\tilde{P}_{i,t,s}^{dg/w}, \tilde{Q}_{i,t,s}^{dg/w}$	Active and reactive fuzzy power generated by each conventional DG/wind turbine unit in bus i in state s and year t
$\tilde{S}_{i,t,s}^{dg}$	Apparent power of non-renewable DG units
$Loss$	Crisp value of total active losses in the distribution network
$\tilde{I}_{\ell,t,s}$	Current magnitude of ℓ^{th} feeder in year t and state s
v_{in}^c, v_{out}^c	Cut-in and cut-out speed of wind turbine
$\tilde{S}_{i,t}^D$	Demand in bus i and year t
ϵ_D	Demand growth rate
T	Evaluation horizon
$\tilde{\zeta}_{i,t}^{dg/w}$	Fuzzy installed capacity of DG units in bus i and year t
$Cap_{i,t}^{dg/w,f}$	Forecasted installed capacity of DG units in bus i and year t

$S_{i,f}^D$	Forecasted demand value in bus i at the beginning of the evaluation horizon
V_{max}, V_{min}	Maximum and minimum operation limits of voltage
$\tilde{P}_{i,t,s}^{net}, \tilde{Q}_{i,t,s}^{net}$	Net active and reactive power injected to bus i , in year t and state s
N_b	Number of buses in the network
π_s	Probability of wind speed in state s
PDF	Probability Density Function
v_{rated}	Rated speed of wind turbine
wp_s	Ratio of wind turbine's generated power to its rated capacity in state s
$VR_{i,t,s}$	Risk of over/under voltage in bus i , year t and state s
c	Scale factor of Rayleigh PDF of wind speed
dg	Set of conventional non-renewable DG units
w	Set of wind turbine units
Ω_s	Set of all states
$v_{1,s}, v_{2,s}$	Starting and ending points of the wind speed's interval defined in state s
S_{max}^{grid}	Thermal limit of the substation
I_{max}^{ℓ}	Thermal limit of ℓ^{th} feeder
D_u	Uncertainty factor of demand values
$\tilde{\delta}_{i,t,s}$	Voltage angle in bus i , in year t and state s
$\tilde{V}_{i,t,s}$	Voltage magnitude in bus i , in year t and state s
v_s	Wind speed in state s

I. INTRODUCTION

DISTRIBUTED generation (DG) is an electric power source directly connected to the distribution network [1]. Several technical, economical and environmental reasons motivate increasing the share of DG units in electricity generation such as: deregulation of power system, progress in DG technologies, reliability improvement [2] and the environmental issues [3]. The DG units may improve the technical performance of the distribution networks if they are installed in an appropriate size and place [1]. Active loss reduction and voltage profile improvement have always been of the important goals of DNOs. Obviously, the first step is calculating these quantities and the next one would be optimizing them with different remedial or preventive actions like network reconfiguration, reactive power support through capacitor placement or smart operation of renewable resources [5]. However the uncertainties associated with investment and

operation of DG units make the calculation of these quantities more complicated [6]. It is mainly due to the different nature of the uncertainties associated with each of the aforementioned data. Some of these data are described using a Probability Density Function (PDF) since the historical data of them is available (e.g., wind speed or solar radiation in the region under study). On the other hand, there is no statistical data available about some of them. In this case, the data are described possibilistically using a fuzzy membership (e.g., operating schedule of gas turbines). A powerful tool is needed for DNOs in order to model the uncertainties associated with the intermittent power generations of wind turbines, investment/operating decisions of DGOs and also the electric load. The motivation of this study is to provide such a tool. In recent years, many approaches have been proposed for active loss minimization and voltage profile improvement using DG units. The literature suggests a wide range of models and methods. Many methods try to minimize the active loss by finding the appropriate location and size of DG units. In these models, it is assumed that the DNO is allowed to perform DG investment in distribution network under its territory [7]. In [8], [9], a powerful probabilistic method is proposed to handle the uncertainties of electric load and intermittent generation of renewable energy resources. In [8], the optimal location of a predetermined number of wind turbines is determined in order to minimize the active losses. In [9], a methodology is proposed for optimally allocating (regarding loss minimization) different types of renewable DG units including wind power, photovoltaic, solar thermal systems, biomass, and various forms of hydraulic power. In [10], a possibilistic method was proposed to handle the uncertainties of electrical loads and energy prices considering different objective functions like cost, technical and economical risks. The unbundling rules in liberalized markets prevents the DNOs of direct DG investment and determination of the location and size of DG units [5]. In [11], a method was proposed to consider the possibilistic and probabilistic uncertainties simultaneously. This method completely considers the unbundling rules. However, due to use of the Monte Carlo Simulation for modeling the probabilistic section, the computational burden was so high. In this paper, a powerful tool for quantifying the impact of DG units on active loss and voltage profile is proposed which considers the unbundling rules. The investment/operating decisions of DGOs are modeled possibilistically while the wind power generation and electric loads are probabilistically treated. This paper is set out as follows: section II describes the uncertainty modeling proposed in this paper, section III presents problem formulation, Simulation results are presented in section IV and finally, section V summarizes the findings of this work.

II. UNCERTAINTY MODELING

A. Possibilistic uncertainty modeling

The concept of possibilistic uncertainty modeling was first introduced by Zadeh [12]. In this method, the uncertain parameter is described using linguistic categories which have fuzzy boundaries [13]. The term ‘‘possibilistic’’ comes from

the fact that the occurrence of each uncertain parameter is possible, (for each degree of belief, α , or membership function value) in a given set of bounds. Suppose that the a multivariate objective function, $y = f(X)$ is given where X is an uncertain variable described using a membership function. In possibilistic evaluation frameworks, for each uncertain value, \tilde{A} , a membership function, $\mu_A(x)$, is defined as the membership degree of each element, x , of universe of discourse, U , to \tilde{A} . Different types of membership functions can be used for describing the uncertain values. Here, fuzzy trapezoidal numbers (FTN) with a notation $\tilde{A} = (a_{\min}, a_L, a_U, a_{\max})$ are used as shown in Fig.1.

1) *α -cut Method:* In engineering problems, the evaluation of a certain quantity is usually in form of a multivariate function like, $y = f(x_1, \dots, x_n)$, if \tilde{x}_i is uncertain then y would become uncertain, $\tilde{y} = f(\tilde{x}_1, \dots, \tilde{x}_n)$. It is of interest that if the membership functions of uncertain input variables \tilde{x}_i are in hand, what would be the membership function of \tilde{y} . The α -cut method [14] can be used to calculate it as follows: For a given fuzzy set \tilde{A} , defined on universe of discourse, U , the crisp set A^α is defined as all elements of U which have membership degree to \tilde{A} , not less than α , as described in (1).

$$\begin{aligned} A^\alpha &= \{x \in U \mid \mu_A(x) \geq \alpha\} \\ A^\alpha &= (\underline{A}^\alpha, \overline{A}^\alpha) \end{aligned} \quad (1)$$

If the α -cut of each input variable, x_i^α , is calculated using (1), then the α -cut of y , y^α is calculated as follows:

$$\begin{aligned} y^\alpha &= (\underline{y}^\alpha, \overline{y}^\alpha) \\ \underline{y}^\alpha &= \min f(X^\alpha) \\ \overline{y}^\alpha &= \max f(X^\alpha) \\ X^\alpha &= [x_1^\alpha, \dots, x_n^\alpha] \in (\underline{X}^\alpha, \overline{X}^\alpha) \end{aligned} \quad (2)$$

In each α -cut, one maximization is done for obtaining the upper bound of y^α , i.e. \overline{y}^α , and one minimization will be done for obtaining the lower bound of y^α , i.e. \underline{y}^α .

2) *Defuzzification:* The defuzzification is a mathematical process for translating a fuzzy number into a crisp one [14]. In this paper, the centroid method [15] is used. The defuzzified value of a given fuzzy number, \tilde{A} , is calculated as follows:

$$A^* = \frac{\int \mu_A(x) \cdot x \, dx}{\int \mu_A(x) \, dx} \quad (3)$$

B. Probabilistic uncertainty modeling

Suppose that a multivariate objective function, $y = f(Z)$ is given where Z is an uncertain vector described by a PDF. There are several methods available to deal with this type of uncertainties like Monte Carlo simulation technique [16], hybrid Cumulant and Gram-Charlier expansion theory [17], Point Estimate Method (PEM) [18] and Latin Hypercube Sampling (LHS) combined with Cholesky decomposition method (LHS-CD) [19]. In this paper, a scenario based approach is used to model the probabilistic uncertainties. In this method, various

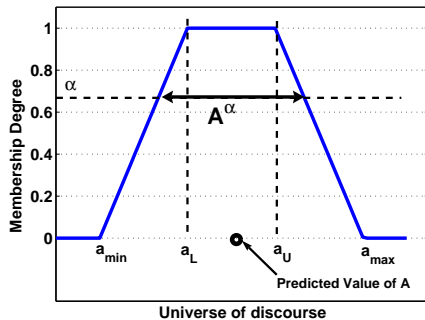

Fig. 1. Fuzzy Trapezoidal Number

scenarios are generated using the PDF of each uncertain variable, Z_s , and the value of y is calculated as follows:

$$y = \sum_{s \in \Omega_s} \pi_s \times f(Z_s) \quad (4)$$

where π_s is the probability of state s , Ω_s is the set of all considered states for describing the uncertain parameter Z .

C. Mixed Probabilistic-possibilistic uncertainty modeling

In realistic problems, the DNO has a multivariate objective function, $y = f(X, Z)$, where the possibilistic uncertain parameters are represented by vector X and probabilistic uncertain values are given by vector Z . To deal with such cases, these variables are decomposed into two groups and are dealt with separately as explained in the following steps:

- Step.1 : Generate the scenario set describing the behavior of Z , i.e. Ω_s
- Step.2 : Calculate (\bar{y}^α) and (\underline{y}^α) as follows:

$$\underline{y}^\alpha = \min \sum_{s \in \Omega_s} \pi_s \times f(Z_s, X^\alpha) \quad (5)$$

$$\bar{y}^\alpha = \max \sum_{s \in \Omega_s} \pi_s \times f(Z_s, X^\alpha)$$

$$X^\alpha \in (\underline{X}^\alpha, \bar{X}^\alpha)$$

- Step.3 : Calculate the crisp value of y using (3)

III. PROBLEM FORMULATION

The calculation of technical indices at presence of different uncertainties is formulated in this section. The assumptions and technical constraints are described as follows:

A. Assumptions

The following assumptions are employed in problem formulation:

- Connection of a DG unit to a bus is modeled as a negative PQ load with a constant power factor [20].
- The DNOs are not authorized to invest in DG units and the decisions of DGOs regarding the operation/investment of these units can only be forecasted.

B. Uncertainty modeling

The uncertainties of electrical loads, power generation of renewable and conventional DG units and investment decisions of DGOs are modeled in this section, as follows:

1) *Electric load*: Various methods have been proposed in the literature for modeling the uncertainties of load forecasts. These models are even probabilistic (like [21] which assumes that a PDF is available for load values or [9] which describes the load values in discrete values with priory known probabilities) or possibilistic (like [1], [22]–[24]). Here, it assumed that no statistical data of load values is available. The electric load is modeled using a FTN (see Fig.1) as proposed in [24]. Assuming a predicted value of load, $S_{i,f}^D$, and a demand growth rate of ϵ_D , the demand in bus i , in year t can be calculated as:

$$\tilde{S}_{i,t}^D = \left(1 - D_u, 1 - \frac{D_u}{2}, 1 + \frac{D_u}{2}, 1 + D_u\right) \times S_{i,f}^D \times (1 + \epsilon_D)^t \quad (6)$$

where D_u is the uncertainty factor of demand (and varied between zero and one), $\tilde{S}_{i,t}^D$ is the apparent demand in bus i and year t .

2) *Wind speed and wind turbine power generation*: The generation schedule of a wind turbine mainly depends on the wind speed in the site. The variation of wind turbine power generation is an uncertain parameter which is consistent with historical data records of wind speed and probabilistically modeled [8], [25]. In this paper, the variation of wind speed, v , is modeled using a Rayleigh PDF [8]. The power-curve of a wind turbine relates the wind speed and the output of a wind turbine.

$$PDF(v) = \left(\frac{2v}{c^2}\right) \exp\left[-\left(\frac{v}{c}\right)^2\right] \quad (7)$$

The generated power of the wind turbine is determined using its characteristics as follows:

$$P_i^w(v) = \begin{cases} 0 & \text{if } v \leq v_{in}^c \text{ or } v \geq v_{out}^c \\ \frac{v - v_{in}^c}{v_{rated}^c - v_{in}^c} P_{i,r}^w & \text{if } v_{in}^c \leq v \leq v_{rated} \\ P_{i,r}^w & \text{else} \end{cases} \quad (8)$$

Where, $P_{i,r}^w$ is the rated power of wind turbine installed in bus i . The speed-power curve of a typical wind turbine is depicted in Fig. 2.

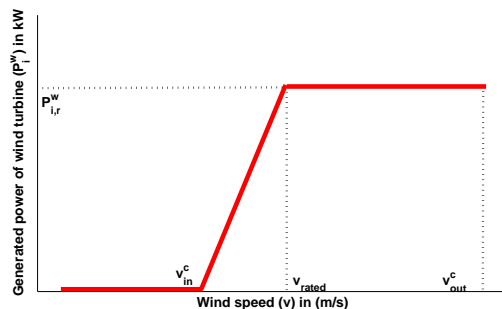

Fig. 2. The idealized power curve of a wind turbine

Using the technique described in [8], the PDF of wind speed is divided into several states. In each state, the probability of

falling into this state is calculated as follows:

$$\pi_s = \int_{v_{1,s}}^{v_{2,s}} \left(\frac{2v}{c^2}\right) \exp\left[-\left(\frac{v}{c}\right)^2\right] dv \quad (9)$$

$$v_s = \frac{v_{2,s} + v_{1,s}}{2}$$

where $v_{1,s}, v_{2,s}$ are the starting and ending points of the wind speed's interval defined in state s , respectively. The generated power of wind turbine in state t is calculated using the obtained v_s and (8).

3) *Operating/Investment decisions of DGOs*: In liberalized electricity markets, the DGO decides about the DG investment/operation according to its own benefits (not the requirements of the DNO). If these decisions do not violate the technical constraints of the network, the DNO can not change them. The DNO needs a model to handle the uncertainty associated with the decisions of DGOs. The problem is that the behaviors of DGOs regarding the operation/investment of DG units can not be modeled using conventional probabilistic tools. This is mainly because there is no PDF of statistical data available about the decisions of DGOs. If the DG technology is wind turbine then the generated power of each wind turbine depends mainly on the weather condition (or control aspects that may influence the wind generation) and if it is a conventional DG technology like gas turbine then the DGO decides about its operating schedule. In this paper, it is assumed that the operation of wind turbines are only affected by weather condition (wind speed) and a fuzzy method is proposed for describing the DG investment (for both renewable and non-renewable DGs) and operation schedule (just for conventional controllable non-renewable DGs) of DGOs as follows:

Fuzzy installed capacity: In this paper, the installed capacity of non-renewable DG units/wind turbines are modeled as a FTN, namely $\tilde{\zeta}_i^{dg/w}$, as follows:

$$\tilde{\zeta}_{i,t}^{dg/w} = (\zeta_{\min}^{dg/w}, \zeta_L^{dg/w}, \zeta_U^{dg/w}, \zeta_{\max}^{dg/w}) \times Cap_{i,t}^{dg/w,f} \quad (10)$$

where $Cap_{i,t}^{dg,f}, Cap_{i,t}^{w,f}$ denote the predicted value of non-renewable/wind DG capacity to be installed in bus i and year t .

Fuzzy DG generation: In this paper, the apparent power of non-renewable DG units are modeled as a FTN, namely $\tilde{S}_{i,t,s}^{dg}$, as follows:

$$\tilde{S}_{i,t,s}^{dg} \leq \sum_{t=1}^t \tilde{\zeta}_{i,t}^{dg} \quad (11)$$

Although the capacity of installed DG in a given bus, $\tilde{\zeta}_i^{dg}$, is uncertain but the DG generation, $\tilde{S}_{i,t,h}^{dg}$, can not exceed the installed capacity of DG unit in each α -cut. The active power of wind turbines depends on both wind speed and also the investment decision of DGOs as described below:

$$\tilde{P}_{i,t,s}^w = \sum_{t=1}^t \tilde{\zeta}_{i,t}^w \times P_i^w(v_s) \quad (12)$$

$$wp_s = \frac{P_i^w(v_s)}{P_{i,r}^w}$$

C. Constraints

1) *Power flow constraints*: The power flow equations that should be satisfied for each state are:

$$\tilde{P}_{i,t,s}^{net} = -\tilde{P}_{i,t}^D + \sum_{dg/w} \tilde{P}_{i,t,s}^{dg/w} \quad (13)$$

$$\tilde{Q}_{i,t,s}^{net} = -\tilde{Q}_{i,t}^D + \sum_{dg/w} \tilde{Q}_{i,t,s}^{dg/w}$$

$$\tilde{P}_{i,t,s}^{net} = \tilde{V}_{i,t,s} \sum Y_{ij} \tilde{V}_{j,t,s} \cos(\tilde{\delta}_{i,t,s} - \tilde{\delta}_{j,t,s} - \theta_{ij})$$

$$\tilde{Q}_{i,t,s}^{net} = \tilde{V}_{i,t,s} \sum Y_{ij} \tilde{V}_{j,t,s} \sin(\tilde{\delta}_{i,t,s} - \tilde{\delta}_{j,t,s} - \theta_{ij})$$

where $\tilde{P}_{i,t}^D, \tilde{Q}_{i,t}^D$ are the active and reactive power demand in bus i and year t , respectively. $\tilde{P}_{i,t,s}^{net}, \tilde{Q}_{i,t,s}^{net}$ are the net active and reactive power injected to bus i , in year t and state s , respectively. $\tilde{P}_{i,t,s}^{dg/w}, \tilde{Q}_{i,t,s}^{dg/w}$ are the active and reactive fuzzy power generated by each conventional DG/wind turbine unit in bus i , in state s and year t , respectively.

2) *Voltage profile*: The voltage magnitude of each bus should be kept between the safe operation limits.

$$V_{\min} \leq \tilde{V}_{i,t,s} \leq V_{\max} \quad (14)$$

where V_{\min} and V_{\max} are the minimum and maximum safe operating limits of voltage, respectively.

3) *Thermal limit of feeders and substation*: To maintain the security of the feeders and substations, the flow of current/energy passing through them should be kept below their thermal limit, $I_{\max}^{\ell}/S_{\max}^{grid}$, as follows:

$$\begin{aligned} \tilde{I}_{\ell,t,s} &\leq I_{\max}^{\ell} \\ \tilde{S}_{t,s}^{grid} &\leq S_{\max}^{grid} \end{aligned} \quad (15)$$

where $\tilde{I}_{\ell,t,s}$ is the fuzzy current magnitude of feeder ℓ in state s and year t ; $\tilde{S}_{t,s}^{grid}$ is the fuzzy apparent power passing through substation's transformer in state s and year t .

D. Evaluation Indices

1) *Active loss*: The reduction of active losses in electric power distribution networks can be regarded as a source of energy [26] and it can also be translated into the avoided costs. When the DNO is aware of the impact of DG units in loss reduction, this deviation can be allocated to them as an economic signal [27]. The total active loss in the network is the sum of all active injection power into the network (the loads are regarded as negative injections). Since some of these values are described as a fuzzy number (like load values and injection of non-renewable DG technologies) and some of them are stochastically modeled (like wind turbine power generation) then the active loss would become a mixed uncertain parameter. It is calculated as follows:

$$\tilde{Loss} = \sum_{t=1}^T \sum_{i=1}^{N_b} \sum_{s \in \Omega_s} \pi_s \times \tilde{P}_{i,t,s}^{net} \times 8760 \quad (16)$$

$$Loss = (\tilde{loss})^*$$

The (16) is explained as follows: The $\sum_{s \in \Omega_s} \pi_s \times$ calculates the expected value of fuzzy number $\tilde{P}_{i,t,s}^{net}$ and then this value

will be added over all buses to obtain the fuzzy active loss in year t . The \tilde{Loss} will be obtained by summing up this value over the evaluation horizon T . The crisp value of $Loss$ is obtained using the “*” operator as described in (3).

2) *Technical risk* : The possibility of occurrence of under/over-voltage in load nodes is assumed as technical risk. The technical voltage risk in node i and year t , is calculated as follows [10]:

$$VR_{i,t,s} = \frac{A_1 + A_3}{A_1 + A_2 + A_3} \quad (17)$$

where $A_{1 \rightarrow 3}$ are depicted in Fig.3. The average value of

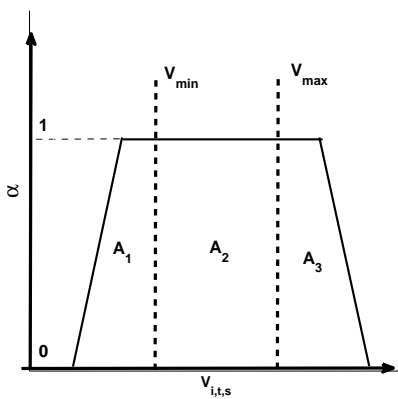

Fig. 3. Technical risk of over/under voltage in bus i

$VR_{i,t,s}$ over all buses of the network and states, can provide some information about the overall voltage condition in year t . Additionally, the severity of over/under voltage should be also taken into account. To do this, an index named *Trisk* is proposed in this paper as follows:

$$Trisk = w_1 \times \max_{i,t} \left(\sum_{\Omega_s} \pi_s \times VR_{i,t,s} \right) + w_2 \times \sum_{t=1}^T \sum_{i=1}^{N_b} \sum_{\Omega_s} \pi_s \times \frac{VR_{i,t,s}}{T \times N_b} \quad (18)$$

where T is the evaluation horizon and N_b is the number of buses in the network. w_1 and w_2 are the weighting factors specified by DNO. The importance of severity of technical risk is specified by w_1 which is multiplied into the first term because it finds the maximum technical risk in the network over the evaluation horizon T . On the other hand, the average technical risk is found by the second term, $\sum_{t=1}^T \sum_{i=1}^{N_b} \sum_{\Omega_s} \pi_s \times \frac{VR_{i,t,s}}{T \times N_b}$. The w_2 specifies the importance of average technical risk over the network during the evaluation horizon.

IV. SIMULATION RESULTS

The proposed algorithm was implemented in General Algebraic Modeling System (GAMS) [28] environment. The successful application of this software have been reported in the literature of power system optimization problems [29]. Two DG technology options, namely, Wind Turbine (WT) and Gas Turbine (GT) are considered here. The mean wind speed in the

region is assumed to be 6.07 m/s . The other characteristics of wind turbine are given in Table I [8]. The weighting factors w_1, w_2 are assumed to be 0.3 and 0.7, respectively. These values can be changed based on the requirements of the DNO. For example, if the DNO is willing to focus on the severity of the technical risks, the value of w_1 should be increased in respect to the values of w_2 , and vice versa. It is described using the Fig.4.

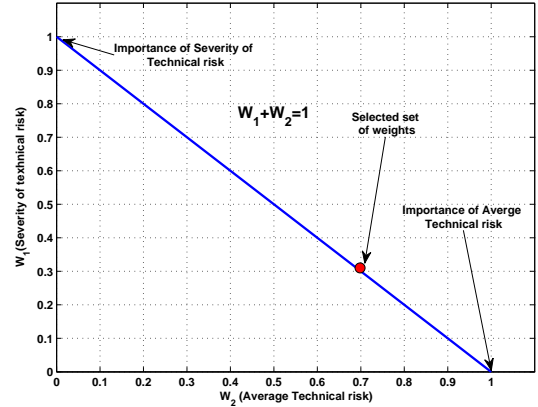

Fig. 4. The set of weight values and their meaning

The demand growth rate, ϵ_D , is 2% for both cases. The time resolution for DG investment is assumed to be one year. Using the technique described in section III-B2, 12 states are

TABLE I
THE TECHNICAL CHARACTERISTICS OF WIND TURBINES

v_{in}^c (m/s)	v_{rated} (m/s)	v_{out}^c (m/s)	$P_{i,r}^w$ (MW)
4	14	25	0.5

determined for each wind turbine which are given in Table II.

TABLE II
WIND TURBINE STATES

States (Ω_s)	wp_s (%)	π_s
1	0	0.2059
2	5	0.0661
3	15	0.1123
4	20	0.1037
5	35	0.1122
6	45	0.0912
7	55	0.0773
8	65	0.0501
9	75	0.0451
10	85	0.0326
11	95	0.0250
12	100	0.0784

The proposed methodology is applied to two distribution systems to demonstrate its abilities. The first case is a 9-node distribution test system and the second one is a large scale real 201-node distribution network. The evaluation horizon, T , is assumed to be 10 years. The uncertainty factor of demand, D_u is assumed to be 5% in both cases [23]. V_{max} and V_{min} are considered to be 1.05 and 0.95 Pu, respectively [10].

A. Case I: 9-node test distribution network

This case is a 11-kV, 9-bus distribution network which is shown in Fig.5. This network is fed through one substation and

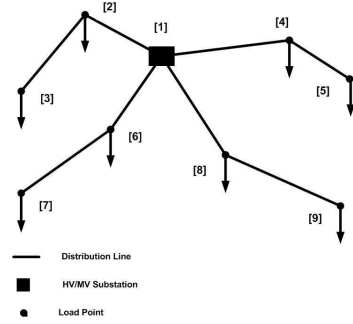

Fig. 5. Distribution test system

has 8 aggregated load points. The technical characteristics of the network can be found in [10]. The predicted values of DG capacities are given in Table III. The technical risk of the given network when no DG unit (neither non-renewable nor wind turbines) exists in the network is 0.640 and the crisp value of active loss is 175296.84 MWh. Three different scenarios were created and assessed to demonstrate the proposed value, namely:

- Scen 1. Non-renewable DG units
- Scen 2. Renewable wind turbines
- Scen 3. Mixed non-renewable and renewable DG units

1) *Scen 1. Non-renewable DG units* : In this scenario, no wind turbine is considered in the assessment. With this assumption, there is no stochastic variable in the model. It is assumed that just one GT with the size of 5 MVA is installed in the network. This DG is installed in bus i and year t . The installation bus, i , is changed from 2 to 9. The installation year t is also changed from 1 to T to analyze the impact of this decision on active losses and technical risks. In Fig.6 and Fig.7 the variations of crisp active loss versus the change in installation year is depicted. Each graph corresponds to a specific node in the network.

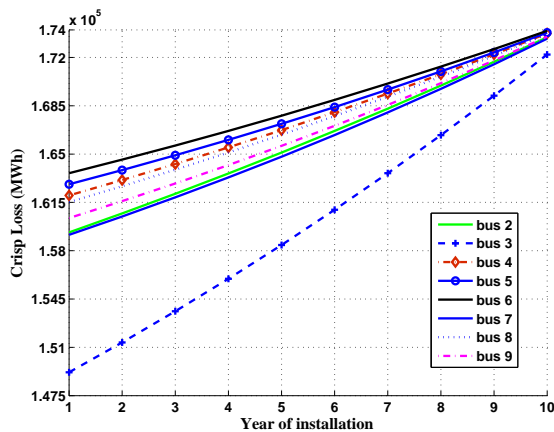

Fig. 6. The variation of crisp active loss with variation in node and year of DG installation

The simulation result shows that the power injection by DG units (with the specified size) reduces both active loss and technical risk. However the magnitude of this reduction highly depends on where and when this DG will be connected to the network. As the installation year gets closer to the beginning of the evaluation horizon, the technical risk and the active losses are more reduced. Another aspect is the location of this unit. It can be concluded from Fig.6 that bus no 3 is the best location for loss reduction because regardless of the installation year, it shows more reduction in active loss compared to other nodes of the network. From technical point of view, bus no 5 has lower technical risk compared to other nodes as shown in Fig.7. These results are obtained by solving the load flow equations and may vary with the topology of the network and its components.

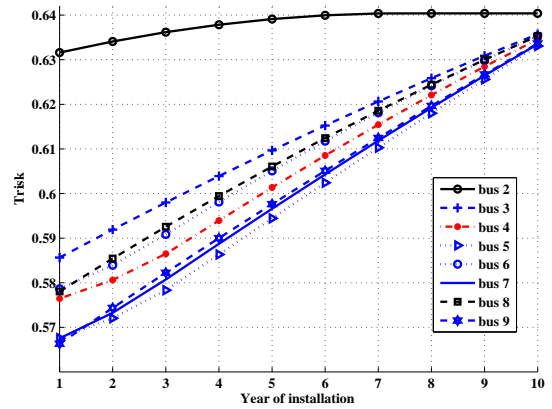

Fig. 7. The variation of technical risk with variation in node and year of DG installation

The penetration level of DG units also changes the technical indices. In this study, it is assumed that the size of each DG units is 0.5 MVA. To analyze the impact of DG penetration level, the number of installed DG unit in each bus is varied and the technical risk and active loss are calculated. The variation of technical risk and active loss are depicted in Fig. 8 and Fig. 9, respectively.

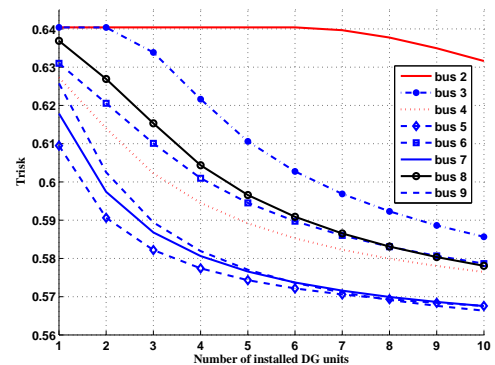

Fig. 8. The variation of technical risk with variation in number of installed DG

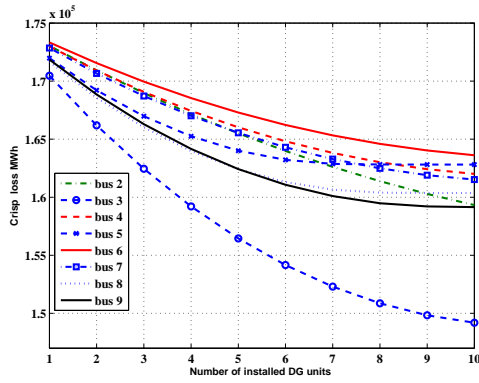

Fig. 9. The variation of crisp loss with variation in number of installed DG

It is important to recognize the impact of DG penetration and also the order in which the DG units will be connected to the distribution network, on the technical risks. To do this, the DG units on various sizes and locations are connected to the network. First, it is assumed that one DG unit is connected to bus “X” and then it is connected to the bus “Y” and finally two DG units (with the same sizes) are connected to bus “X” and “Y” simultaneously. In each case, the technical risk index is calculated. For the given 9-node network, $8 \times 7 \times 15 = 840$ simulation analysis are performed to explore all combination of buses and DG sizes (it is assumed all buses of the network are candidate for DG installation except the slack node and the second DG will be installed in a bus other than the first bus).

In most cases, when both of the DG units are connected, the technical risk is lower than the single DG case. In some cases, as depicted in Fig.10, installing the second DG may increase the technical risk. In Fig.10 there are three graphs labeled with X, Y and XY are depicted. All of these graphs shows the technical risk throughout the network but each of them shows something special.

- The graph X shows the technical risk when just one DG is installed in bus 4,
- The graph Y shows the technical risk when just one DG is installed in bus 5,
- The graph XY shows the technical risk when both DGs are installed in the network one in bus 4, and the other one in bus 5.

The technical risk in case of single DG (just in bus “X” or “Y”) has a decreasing pattern when the DG size is less than 14MW. In case of two DG units (both of them are installed, one in bus “X” and the other one in bus “Y”), the technical risk decreases until DG capacity reaches to 9 MW. After the 9MW threshold, the technical risk will increase. Comparing the values of technical risk between these three cases, it can be concluded from Fig. 10 that if the first bus is bus #4, then connecting another DG in bus 5 will decrease the technical risk. It is true until the size of the second DG (in bus #5) is below the 11 MW. On the other hand, if there exists a DG unit in bus “Y”, installing a second DG in bus “X” will decrease the technical risk until the capacity of the second DG is below the 10 MW. The increase/decrease of technical

risk highly depends on the topology of the network under study, size of DG units and operation strategy of DGOs. The

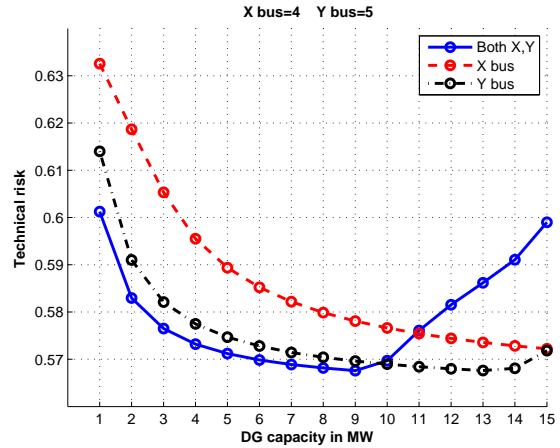

Fig. 10. The comparison between the technical risk due to order of DG connection in bus 4,5

technical risk would happen in under/over voltage in this study. The network is exposed to the under voltage condition when no DG is installed in the network. The power injection by DG units helps the network to improve its voltage condition. With increasing the capacity of DG units from a specific value (here 9 MW) the under voltage problem would change into the over voltage problem as it is depicted in Fig.10.

2) *Scen 2. Renewable DG units (wind turbine)* : In this scenario, just wind turbine is considered in the assessment. The size of wind turbine is assume to be 5 MVA and just one wind turbine is installed in the network. In Fig.11 and Fig.12 the variation of crisp active loss and technical risk versus the installation year is depicted. Each graph corresponds to a specific node in the network.

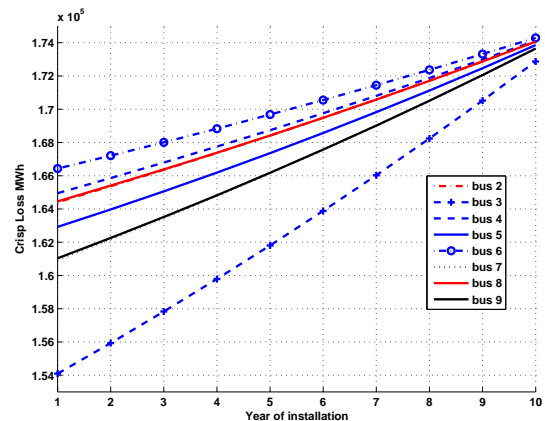

Fig. 11. The variation of crisp active loss with variation in node and year of wind turbine installation

Fig. 11 shows that WT installation in node 3 leads to more active loss reduction compared to all other buses of the network. Fig. 12 states that node 5 is the best location for technical risk reduction in the network since it has the least Trisk compared to all other buses of the network. The

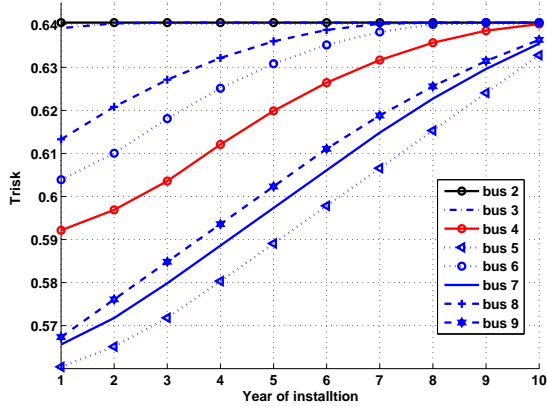

Fig. 12. The variation of technical risk with variation in node and year of wind turbine installation

penetration level of DG units also changes the technical indices. In this study, it is assumed that the size of each wind turbine is 0.5 MVA. To analyze the impact of wind turbine penetration level, the number of installed wind turbine in each bus is varied and the technical risk and active loss are given in Fig. 13 and Fig. 14, respectively.

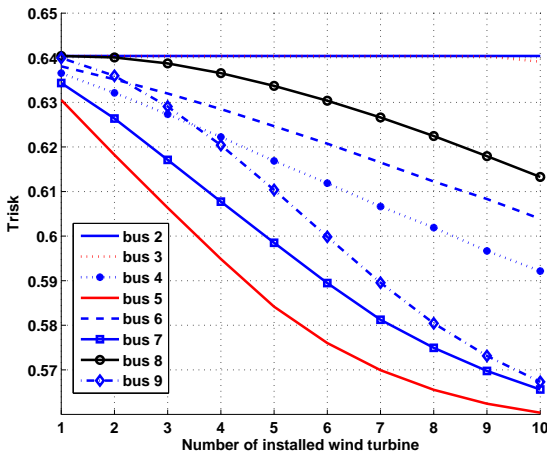

Fig. 13. The variation of technical risk with variation in number of installed WT

The graphs of Fig.13, show that if the objective is loss reduction then the best location for wind turbines would be bus 3. From the technical point of view (according to Fig.14), the best location for wind turbines is bus 5.

3) *Scen 3. Mixed non-renewable and renewable DG units :* In this scenario, both non-renewable and wind turbine units are present in the network. The wind turbines are available in 0.5 MW modules and are assumed to be installed in three locations in the network. The prediction of DNO indicates that the wind turbines are to be installed in bus 5, 8 and 3. The capacity of wind turbines are 4, 0.5 and 1 MW, respectively. The location and year of installation of both gas and wind turbines are given in Table. III. The problem consists of both stochastic and fuzzy variables. The stochastic variables include the generation of

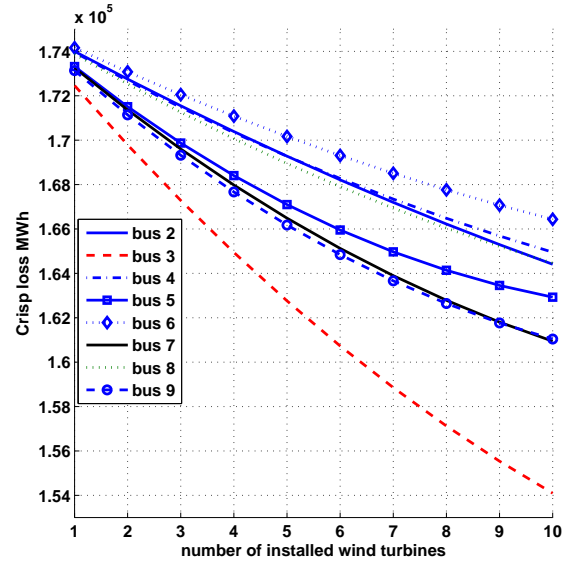

Fig. 14. The variation of crisp loss with variation in number of installed WT

wind turbines and the fuzzy variables include the generation of dispatchable DG units (non-renewable ones). The technical risk is 0.518 and active loss is equal to 130134.4962 MWh.

TABLE III
PREDICTED VALUES OF CAPACITIES TO BE INSTALLED IN CASE-I

DG tech	bus	No of installed	year	Cap	$\frac{dg}{w}_{\min}$	$\frac{dg}{w}_{L}$	$\frac{dg}{w}_{U}$	$\frac{dg}{w}_{\max}$
WT_1	5	8	2	0.5	0.3	0.9	1.05	1.1
WT_2	8	1	3	0.5	0.7	0.8	1	1.15
WT_3	3	2	4	0.5	0.1	0.6	1.1	1.2
GT_1	2	3	1	0.5	0	0.9	1.05	1.1
GT_2	9	1	5	0.2	0	0	1	1.15
GT_3	5	4	3	0.4	0.1	0.6	1.1	1.2

The variation of $\sum_{\Omega_s} \pi_s \times VR_{i,t,s}$ is given in Table. IV. Four buses are exposed to technical risks namely 3,5,7, and 9. The calculated technical risk (as indicated in Table. IV) increases as the time goes on. This means that with the increase of load in each bus, the technical risk increases. The trend in technical risk of bus 3 shows a decrease in year $t = 4$. This is because of DG investment in year $t = 4$ with the capacity of 1 MW (approximately) in this bus. The worst condition of technical risk belongs to bus 7. In this bus, the technical risk starts from 0.703 and rapidly reaches to 1 in year 3. The next critical risk is related to bus 5 which will be 100% in risk in year 7. The provided data can be used by DNO to find out which point of the network and when needs to be reinforced.

B. Case II: A real 201-node distribution network

The proposed methodology is applied to a large 201-node 10 kV distribution system which is shown in Fig.15. The technical data of this network can be found in [30]. The DG locations and capacities are described in Table. V. The technical risk of the network is 0.6367 and the crisp value of active loss is 189477 MWh. The variation of average, maximum and minimum value of the technical risk throughout the network

TABLE IV
THE EXPECTED VALUE OF $VR_{i,t,s}$ OVER THE STATES IN SCENARIO 3 OF
CASE I

t	Bus			
	3	5	7	9
1	0.603	0.541	0.703	0.179
2	0.642	0.199	0.922	0.210
3	0.682	0.376	1	0.117
4	0.448	0.551	1	0.149
5	0.484	0.724	1	0.182
6	0.520	0.894	1	0.214
7	0.557	1	1	0.248
8	0.594	1	1	0.281
9	0.631	1	1	0.315
10	0.668	1	1	0.350

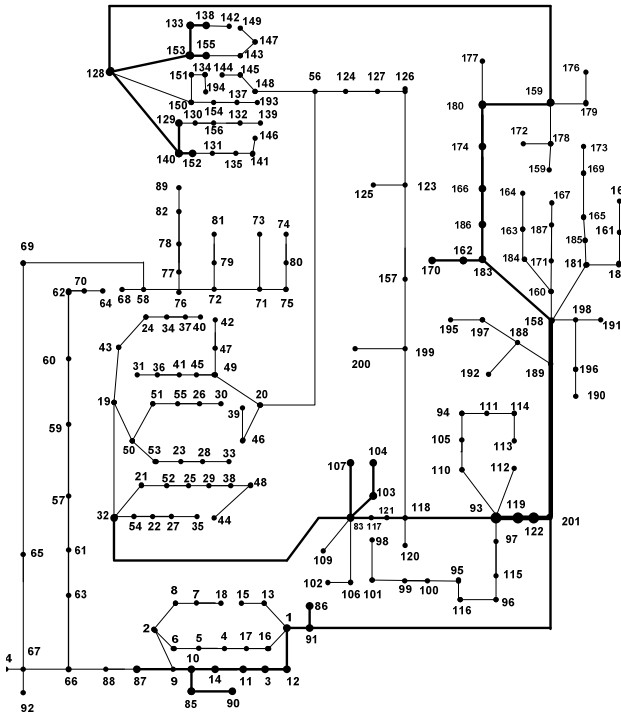

Fig. 15. The geographical view of the real 201-bus distribution network in case II

is depicted in Fig. 16. The minimum average risk is in bus 201 with the average risk of 0.3257 and the worst risk occurs in bus 146 with the average risk of 0.9526 over the evaluation horizon.

The yearly variation of $VR_{i,t,s}$ over some selected buses are described in Table VI.

If the number of scenarios (states) are too high that the computational burden becomes a matter of concern, the scenario reduction method can be used. The purpose of scenario reduction is selection of a set, Ω_S , with the cardinality of N_{Ω_S} , from the original set, Ω_J [31]. This procedure should be done in a way that makes a trade off between the loss of data and decreasing the computational burden. The details

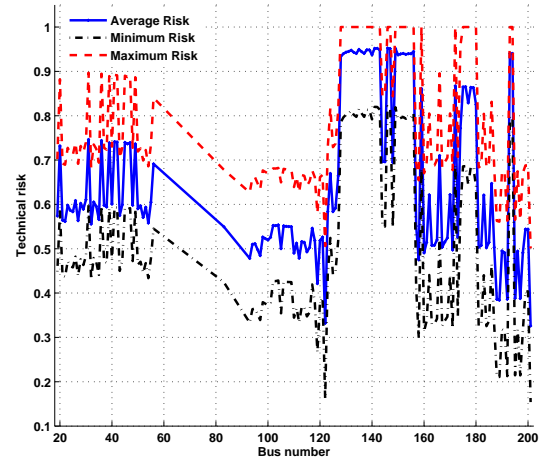

Fig. 16. The variation of the technical risk throughout the network in case II

TABLE V
PREDICTED VALUES OF CAPACITIES TO BE INSTALLED IN CASE II

DG tech	bus	number of installed units	year
WT_1	93	8	1
WT_2	128	4	1
WT_3	158	6	1
GT_1	32	7	1
GT_2	69	4	1
GT_3	83	6	1

of this procedure can be found in [32]. In this paper, for avoiding the complexity of the calculations, the impact of unbalanced phases/loads in distribution network load flow equations is neglected. However if an unbalanced multiphase load-flow algorithm is needed with the capability to model all components and network features, the proposed algorithm can be extended using the methods proposed in [33], [34]. The application of the proposed method can be defined as minimizing the evaluated indices. This can be done using the reinforcement strategies, capacitor installation, distribution network reconfiguration and etc. Knowing the impacts of DGO's decisions on technical performance of the distribution networks can help the regulators as an economic signals to reward/penalize their actions [35]. In several parts of a constrained network there can be substantial benefit from DG operation (such as reducing the technical risks, active losses, needs for network reinforcement) and agreements reached that make operation more aligned with DNO needs. In this case, a win-win strategy may be defined as provision of some incentives for DG developers in some buses of the network by DNO. The benefit sharing, cost causation-based distribution tariff [36], efficient nodal pricing for efficiency enhancing DG [37] and locational marginal pricing methods can be used to achieve this goal. Another application of the proposed method for DNO would be evaluating the DGO's proposal for new DG connection and analyzing its impact on the technical performance of the network. It may influence the DG connection permission that can be granted by DNO to DGO.

TABLE VI
THE EXPECTED VALUE OF $VR_{i,t,s}$ OVER THE SCENARIOS IN CASE II

t	Bus									
	201	189	158	105	52	186	166	174	159	128
1	0.154	0.211	0.299	0.354	0.446	0.466	0.527	0.587	0.681	0.786
2	0.191	0.248	0.337	0.386	0.473	0.506	0.567	0.628	0.722	0.827
3	0.229	0.286	0.376	0.418	0.500	0.545	0.607	0.668	0.764	0.869
4	0.267	0.325	0.415	0.450	0.527	0.586	0.648	0.709	0.805	0.911
5	0.305	0.363	0.454	0.483	0.555	0.626	0.689	0.750	0.847	0.953
6	0.344	0.402	0.494	0.515	0.584	0.667	0.730	0.792	0.889	0.994
7	0.383	0.442	0.533	0.549	0.612	0.708	0.771	0.833	0.931	1.000
8	0.422	0.481	0.573	0.582	0.641	0.749	0.812	0.875	0.973	1.000
9	0.461	0.521	0.614	0.616	0.670	0.790	0.854	0.917	1.000	1.000
10	0.501	0.561	0.654	0.650	0.699	0.831	0.896	0.959	1.000	1.000

C. Comparing the proposed method with Fuzzy-Monte Carlo approach

In this section, a comparison between the proposed method and a Fuzzy-Monte Carlo approach [11] has been made. Both of these methods deal with the problems with mixed types of uncertainties (stochastic and fuzzy). The scenario approach used for handling the stochastic uncertainties tries to overcome the computational burden associated with the Monte Carlo approach. The main concerns are the number of optimizations needed for calculating the indicated indices (which directly determines the simulation time) and the accuracy of the proposed method compared to the exact method (Fuzzy - Monte Carlo Simulation (FMCS) [11]). The results are given in Table VII which gives the values obtained by the proposed method and FMCS, the absolute error, number of optimization needed for each index, in each case and method and finally the simulation times. For example in case II of FMCS, the number of optimizations needed for calculating the technical risk is equal to $2 * 200 * 3000 * 2 = 2400000$. This is because two alpha-cuts, 200 buses (all buses except slack bus), 3000 Monte Carlo Simulations are considered which will be multiplied by two (one for obtaining the maximum value and one for the minimum value as explained in (5)). This is while the number of optimizations needed for the proposed method in the same case, is 400. It is evident from the Table VII that the computational burden (run time) is highly decreased while the accuracy is maintained within the acceptable bound (the absolute error is below the 3%). Comparing the CPU time needed for case I and II, shows that the algorithm is applicable in both small and large scale distribution networks with reasonable computation burden.

D. Discussion of the results

Observing the results of the simulations, the following remarks can be made:

- The active losses, technical risks depend on the penetration level, timing of investment, location and technology of DG units.
- The risk of voltage limit violation decreases with increasing the penetration level of DG units. If the penetration level passes a specific limit then the technical risk starts to increase. This limit mainly depends on the topology of the network under study and DG technology.
- From the obtained diagrams of all of scenarios, the DNO can have some information about the impact of DG units on technical index of the distribution network.

- The proposed index for technical risk not only shows the severity of the risk but also gives the probability of occurrence for this event. The DNO can be also alarmed about the time and location of starting the technical risk during the evaluation horizon. Knowing this information can help the DNO to make the proper remedial or preventive decision in time.
- Comparing the proposed approach with fuzzy-Monte Carlo approach shows that it can give an accurate result with much less computational burden. The computational capability of the proposed methodology enables it to be applicable even on large scale distribution networks.

V. CONCLUSION

This paper presents a hybrid possibilistic-probabilistic tool to assess the impact of DG units on technical performance of distribution network. The uncertainty of electric loads, DG operation/investments are taken into account. The formulated problem was formulated under GAMS environment. The proposed method can help the DNOs to evaluate the technical performance of the distribution network when the installation/operation decisions related to DG units are made by non-DNO entities (like private investors). These decisions are highly uncertain and the DNOs should be equipped with powerful tools to handle them and be able to operate their networks in an economic, efficient and coordinated manner in providing high quality service to consumers. Although the evaluated indices are considered to be the total active losses and technical risk of voltage limit violation but the generality of the proposed framework enables the DNO to extend it to consider other evaluation indices and other risks like overloading the feeders/substation. This novel tool is applied to two distribution networks and its flexibility is demonstrated through different scenarios.

ACKNOWLEDGMENT

The author would like to thank the anonymous reviewers who have basically improved the quality of this work with their insightful comments.

REFERENCES

- [1] A. Soroudi, M. Ehsan, R. Caire, and N. Hadjsaid, "Possibilistic evaluation of distributed generations impacts on distribution networks," *Power Systems, IEEE Transactions on*, vol. 26, no. 4, pp. 2293–2301, nov. 2011.
- [2] J. Driesen and F. Katiraei, "Design for distributed energy resources," *Power and Energy Magazine, IEEE*, vol. 6, no. 3, pp. 30–40, 2008.
- [3] R. Prasad, R. Bansal, and M. Sauturaga, "Some of the design and methodology considerations in wind resource assessment," *Renewable Power Generation, IET*, vol. 3, no. 1, pp. 53–64, 2009.
- [4] EPRI, "Creating incentives for electricity providers to integrate distributed energy resources," Electric Power Research Institute, Tech. Rep., Nov 2007.
- [5] L. F. Ochoa and G. P. Harrison, "Minimizing energy losses: Optimal accommodation and smart operation of renewable distributed generation," *Power Systems, IEEE Transactions on*, vol. 26, no. 1, pp. 198–205, 2011.
- [6] A. Soroudi, M. Ehsan, R. Caire, and N. Hadjsaid, "Hybrid immune-genetic algorithm method for benefit maximisation of distribution network operators and distributed generation owners in a deregulated environment," *Generation, Transmission Distribution, IET*, vol. 5, no. 9, pp. 961–972, september 2011.

TABLE VII
THE COMPARISON BETWEEN THE PROPOSED METHOD AND THE FUZZY MONTE CARLO SIMULATION

Method	Case	Values		Error (%)		Number of optimizations		Evaluation time (s)	
		loss (MWh)	Trisk	loss	Trisk	loss	Trisk	loss	Trisk
FMCS [11]	I(scen3)	132679	0.531	-	-	2*3000*2	2*8*3000*2	5434.108	45974.023
	II	193234	0.652	-	-	2*3000*3	2*200*3000*2	12416.075	96538.230
Proposed	I (scen3)	130134	0.518	1.919	2.536	2*2	2*200	1.818	16.150
	II	189477	0.637	1.945	2.493	2*2	2*200	4.446	34.729

- [7] A. Soroudi and M. Ehsan, "A distribution network expansion planning model considering distributed generation options and techno-economical issues," *Energy*, vol. 35, no. 8, pp. 3364 – 3374, 2010.
- [8] Y. Atwa and E. El-Saadany, "Probabilistic approach for optimal allocation of wind-based distributed generation in distribution systems," *Renewable Power Generation, IET*, vol. 5, no. 1, pp. 79 –88, 2011.
- [9] Y. M. Atwa, E. F. El-Saadany, M. M. A. Salama, and R. Seethapathy, "Optimal renewable resources mix for distribution system energy loss minimization," *IEEE Transactions on Power Systems*, vol. 25, no. 1, pp. 360 –370, Feb. 2010.
- [10] M.-R. Haghifam, H. Falaghi, and O. Malik, "Risk-based distributed generation placement," *IET Gen., Trans. and Distri.*, vol. 2, no. 2, pp. 252–260, March 2008.
- [11] A. Soroudi and M. Ehsan, "A possibilistic-probabilistic tool for evaluating the impact of stochastic renewable and controllable power generation on energy losses in distribution networks—a case study," *Renewable and Sustainable Energy Reviews*, vol. 15, no. 1, pp. 794 – 800, 2011.
- [12] L. A. Zadeh, "Fuzzy sets as a basis for a theory of possibility," *Fuzzy sets system*, vol. 1, no. 2, pp. 3–28, 1978.
- [13] R. Yager, "Determining equivalent values for possibilistic variables," *Systems, Man, and Cybernetics, Part B: Cybernetics, IEEE Transactions on*, vol. 31, no. 1, pp. 19 –31, feb 2001.
- [14] H. Zhang and D. Liu, Eds., *Fuzzy Modeling and Fuzzy Control*. Birkhuser, 2006.
- [15] T. Ross, *Fuzzy Logic with Engineering Applications, Third Edition*. USA: John Wiley, 2010.
- [16] A. Leite da Silva and V. Arienti, "Probabilistic load flow by a multilinear simulation algorithm," *Generation, Transmission and Distribution, IEE Proceedings C*, vol. 137, no. 4, pp. 276 –282, Jul. 1990.
- [17] P. Zhang and S. Lee, "Probabilistic load flow computation using the method of combined cumulants and gram-charlier expansion," *IEEE Transactions on Power Systems*, vol. 19, no. 1, pp. 676 – 682, 2004.
- [18] J. Morales, L. Baringo, A. Conejo, and R. Minguez, "Probabilistic power flow with correlated wind sources," *Generation, Transmission Distribution, IET*, vol. 4, no. 5, pp. 641 –651, May 2010.
- [19] S. Wong, K. Bhattacharya, and J. Fuller, "Electric power distribution system design and planning in a deregulated environment," *Generation, Transmission Distribution, IET*, vol. 3, no. 12, pp. 1061 –1078, december 2009.
- [20] L. Ochoa, A. Padilha-Feltrin, and G. Harrison, "Evaluating distributed generation impacts with a multiobjective index," *IEEE Trans. on Power Deli.*, vol. 21, no. 3, pp. 1452–1458, July 2006.
- [21] C.-L. Su, "Stochastic evaluation of voltages in distribution networks with distributed generation using detailed distribution operation models," *Power Systems, IEEE Transactions on*, vol. 25, no. 2, pp. 786 –795, may 2010.
- [22] H. Khodr, Z. Vale, and C. Ramos, "Notice of violation of IEEE publication principles a benders decomposition and fuzzy multicriteria approach for distribution networks remuneration considering dg," *Power Systems, IEEE Transactions on*, vol. 24, no. 2, pp. 1091 –1101, may 2009.
- [23] M. Matos and E. Gouveia, "The fuzzy power flow revisited," *IEEE Transactions on Power Systems*, vol. 23, no. 1, pp. 213–218, Feb. 2008.
- [24] E. M. Gouveia and M. A. Matos, "Symmetric ac fuzzy power flow model," *European Journal of Operational Research*, vol. 197, no. 3, pp. 1012 – 1018, 2009.
- [25] Y. Ding, P. Wang, L. Goel, P. C. Loh, and Q. Wu, "Long-term reserve expansion of power systems with high wind power penetration using universal generating function methods," *Power Systems, IEEE Transactions on*, vol. 26, no. 2, pp. 766 –774, may 2011.
- [26] L. Queiroz and C. Lyra, "Adaptive hybrid genetic algorithm for technical loss reduction in distribution networks under variable demands," *Power Systems, IEEE Transactions on*, vol. 24, no. 1, pp. 445 –453, feb. 2009.
- [27] A. Algarni and K. Bhattacharya, "A generic operations framework for discos in retail electricity markets," *Power Systems, IEEE Transactions on*, vol. 24, no. 1, pp. 356 –367, feb. 2009.
- [28] 'GAMS', "A user guide," New York, Tech. Rep., 2008.
- [29] D. Chattopadhyay, "Application of general algebraic modeling system to power system optimization," *Power Systems, IEEE Transactions on*, vol. 14, no. 1, pp. 15 –22, feb 1999.
- [30] P. M. D. O. D. Jesus, "Remuneration of distributed generation: A holistic approach," Ph.D. dissertation, Faculdade de Engenharia. Universidade do Porto, Portugal, 2007.
- [31] J. Morales, S. Pineda, A. Conejo, and M. Carrion, "Scenario reduction for futures market trading in electricity markets," *IEEE Trans. on Power Sys.*, vol. 24, no. 2, pp. 878 –888, May 2009.
- [32] A. J. Conejo, M. Carrion, and J. M. Morales, *Decision Making Under Uncertainty in Electricity Markets*. New York: Springer, 2010.
- [33] M. Dilek, F. de Leon, R. Broadwater, and S. Lee, "A robust multiphase power flow for general distribution networks," *Power Systems, IEEE Transactions on*, vol. 25, no. 2, pp. 760 –768, may 2010.
- [34] W. H. Kersting, *Distribution System Modeling and Analysis, Second Edition (Electric Power Engineering Series)*, 2nd ed. CRC Press, Nov. 2006.
- [35] J. Lo andpez Lezama, A. Padilha-Feltrin, J. Contreras, and J. Mun andoz, "Optimal contract pricing of distributed generation in distribution networks," *Power Systems, IEEE Transactions on*, vol. 26, no. 1, pp. 128 –136, feb. 2011.
- [36] P. Sotkiewicz and J. Vignolo, "Towards a cost causation-based tariff for distribution networks with dg," *IEEE Transactions on Power Systems*, vol. 22, no. 3, pp. 1051 –1060, aug. 2007.
- [37] —, "Nodal pricing for distribution networks: efficient pricing for efficiency enhancing dg," *IEEE Transactions on Power Systems*, vol. 21, no. 2, pp. 1013 – 1014, may 2006.



Alireza Soroudi Received his B.Sc and M.Sc degrees in electrical engineering in 2002 and 2003 respectively from Sharif University of Technology, Tehran, Iran. He received his joint PhD degree from Sharif University of Technology and the Grenoble Institute of Technology (Grenoble-INP), Grenoble, France, in 2011. His research interests are Smart grids, power system planning and uncertainty modeling and optimization methods.