



Title	Identification of Road Irregularities via Vehicle Accelerations
Authors(s)	O'Brien, Eugene J., McGetrick, P., González, Arturo
Publication date	2010
Publication information	O'Brien, Eugene J., P. McGetrick, and Arturo González. "Identification of Road Irregularities via Vehicle Accelerations," 2010.
Conference details	Transport Research Arena Europe 2010, 7-10th June, Brussels, Belgium
Item record/more information	http://hdl.handle.net/10197/4044

Downloaded 2024-04-20 16:01:24

The UCD community has made this article openly available. Please share how this access benefits you. Your story matters! (@ucd_oa)



© Some rights reserved. For more information

Identification of Road Irregularities via Vehicle Accelerations

Eugene J OBrien
Professor
University College Dublin
Newstead Building
Belfield
Dublin 4
Ireland
eugene.obrien@ucd.ie

Patrick McGetrick
Mr
University College Dublin
Newstead Building
Belfield
Dublin 4
Ireland
patrick.mcgetrick@ucd.ie

Arturo González
Dr
University College Dublin
Newstead Building
Belfield
Dublin 4
Ireland
arturo.gonzalez@ucd.ie

Abstract

A periodic monitoring of the pavement condition facilitates a cost-effective distribution of the resources available for maintenance of the road infrastructure network. The task can be accurately carried out using profilometers, but such an approach is generally expensive. This paper presents a method to collect information on the road profile via accelerometers mounted in a fleet of non-specialist vehicles, such as police cars, that are in use for other purposes. It proposes an optimisation algorithm, based on Cross Entropy theory, to predict road irregularities. The Cross Entropy algorithm estimates the height of the road irregularities from vehicle accelerations at each point in time. To test the algorithm, the crossing of a half-car roll model is simulated over a range of road profiles to obtain accelerations of the vehicle sprung and unsprung masses. Then, the simulated vehicle accelerations are used as input in an iterative procedure that searches for the best solution to the inverse problem of finding road irregularities. In each iteration, a sample of road profiles is generated and an objective function defined as the sum of squares of differences between the ‘measured’ and predicted accelerations is minimized until convergence is reached. The reconstructed profile is classified according to ISO and IRI recommendations and compared to its original class. Results demonstrate that the approach is feasible and that a good estimate of the short-wavelength features of the road profile can be detected, despite the variability between the vehicles used to collect the data.

1. Introduction

Road profiles are central to the interaction between a pavement and/or bridge and a heavy vehicle suspension. It follows that the maintenance of road profiles for highways and bridges is important in reducing dynamic tyre forces, promoting long pavement life, improving passenger comfort and ensuring that bridge loads are small (OECD, 1997; Gillespie et al, 1992; Green & Cebon, 1994). This paper outlines a novel approach for the periodic estimation of the pavement profile using low cost accelerometer measurements.

Currently, there exist several methods for the measurement of road surface profiles. Static methods, such as ‘dipstick’ walking profilometers are clearly less efficient than dynamic approaches such inertial profilometers which measure profile tracks at full highway speeds. The typical inertial profilometer consists of a vehicle equipped with a height sensing device, such as

a laser, which measures pavement elevations at regular intervals (Sayers & Karamihas, 1996; Sayers & Karamihas, 1998). Accelerometer(s) allow the effects of vehicle dynamics to be removed from the elevation measurements. This method provides an accurate, high resolution measurement of road profile, though the associated costs of laser-based technology are a disadvantage. González et al (2008) propose a road classification method based on the relationship between the power spectral densities of vehicle accelerations and road profile via a transfer function. This frequency-domain method classifies the road into the appropriate class but it is unable estimate road profile irregularities at each point in time.

Harris et al (2009) investigate a method which uses only accelerometers mounted on a single vehicle. As in this study of multiple vehicles, Harris et al use a combinatorial optimisation technique, known as the cross-entropy method (De Boer et al, 2005; Belay et al, 2008). Knowing only the vehicle dynamic properties and the vehicle response to a road profile, it is possible to infer the road profile elevations. Their investigation uses a half-car roll dynamic model to infer measurements of road profiles in both the left and right wheel paths in a numerical validation. Unknown road profiles are characterised by optimising to find the road profile which replicates the measured response; in this case acceleration measurements, taken from the unsprung and sprung masses of the half-car model for a number of road profiles.

This paper is an extension of the method of Harris et al. In this paper, road profile irregularities are estimated from accelerometers mounted in a fleet of non-specialist vehicles, such as police cars. Six representative half-car roll vehicle models are simulated over a number of road profiles (which vary in ISO class) and the sensitivity of each road inference to vehicle model parameters and noise is examined.

2. Vehicle Fleet Model Parameters

The vehicle model to be used in simulations is a four degree of freedom half-car roll model as described by Harris et al. (Figure 1). This is used as it is possible to infer parallel profiles in the left and right wheel paths. For this investigation it is assumed that the parameters of all six representative vehicles are known and these are given in Table 1. In reality, the vehicle model parameters would be unknown. It is necessary to determine the unknown vehicle model parameters based on known measurements of vehicle response due to a known road profile using combinatorial optimisation i.e. calibrate the vehicle initially (Harris et al, 2009). It then can be used for the identification of unknown pavement profile heights.

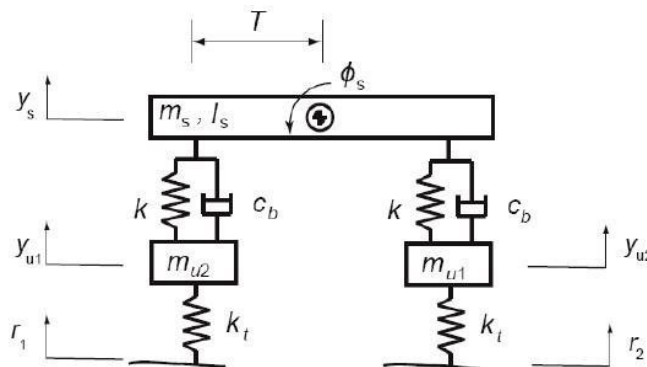

Figure 1 Half-car vehicle roll model

Table 1 Vehicle model parameters

Description	Unit	Vehicle					
		1	2	3	4	5	6
Sprung Mass, m_s	kg	505.36	499.14	490.64	468.29	569.57	534.19
Unsprung Mass, m_{u1}	kg	28.32	26.04	23.06	27.10	27.70	23.59
Unsprung Mass, m_{u2}	kg	24.98	24.49	25.42	23.03	24.16	25.66
Suspension Stiffness, k	kN/m	22.62	22.38	20.06	19.41	19.02	18.62
Tyre Stiffness, k_t	kN/m	136.99	151.58	153.59	137.49	152.98	146.07
Passive damping coefficient, c_b	kNs/m	1.52	1.44	1.54	1.39	1.52	1.48
Roll Moment of Inertia, I_s	kg m ²	777.21	713.86	696.60	619.26	733.41	901.01
Track width, T	m	0.75	0.75	0.75	0.75	0.75	0.75

2.1 Road Profiles

The identification of road irregularities is carried out for all vehicle models on each of the Artificially generated Road profiles, AR1 – AR5, shown in Figure 2, which are 100 m in length. These profiles range from class A to class C roughness according to ISO standards (ISO 8608, 1995) and have IRI ratings ranging from 1.47 – 8.56 m km⁻¹. Table 2 lists, for each profile, the reference spatial frequency, $G_d(n_0)$, used to generate the profiles, the corresponding IRI values and the correlation, ρ_r , between the left and right profiles. The calculation of IRI ratings and analysis of spectral densities in this study is done using ProVAL (**Profile Viewing and AnaLysis**; Chang et al, 2006).

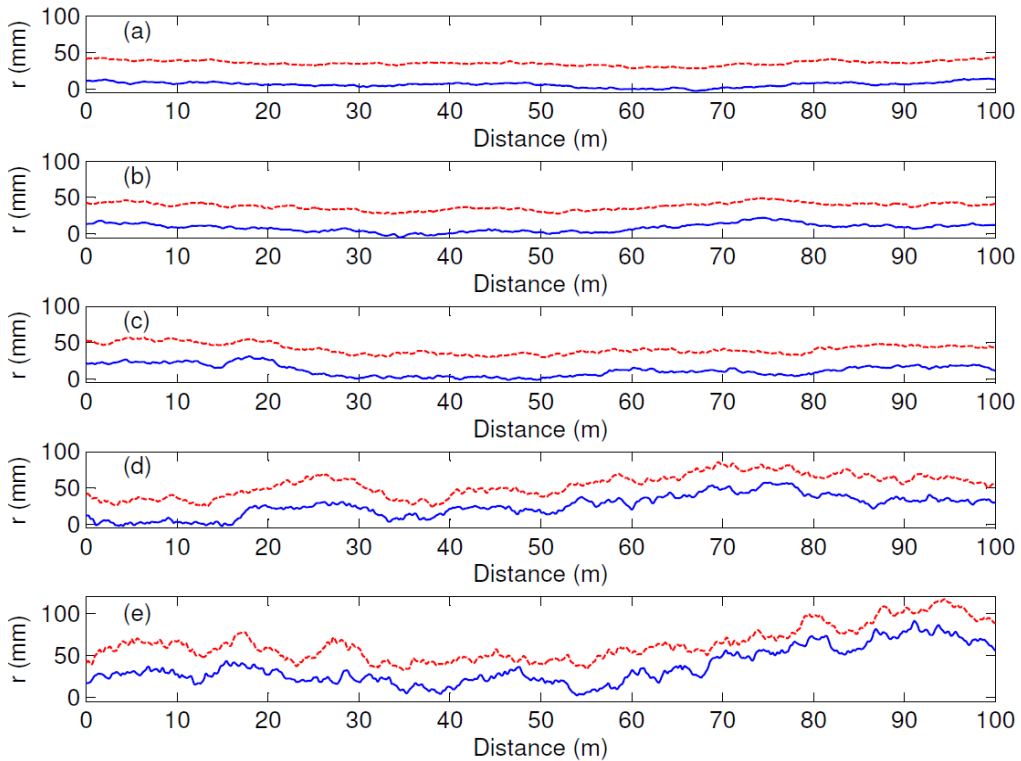

Figure 2 Road profiles used for tests; (—) left wheel path, (---) right wheel path (offset by +30mm for clarity); (a) AR1 (b) AR2 (c) AR3 (d) AR4 (e) AR5

Table 2 Details of road profiles

Profile	ISO Class	$G_d(n_0)$ ($m^3/cycle$)	IRI (m/km)		ρ_r
			Left	Right	
AR1	A	8×10^{-6}	1.48	1.47	0.968
AR2	A	16×10^{-6}	2.27	2.10	0.931
AR3	B	64×10^{-6}	3.09	2.95	0.936
AR4	B/C	128×10^{-6}	6.19	6.28	0.922
AR5	C	256×10^{-6}	8.56	8.27	0.926

3. Results of Road Profile Inference

For each road profile, all vehicle models are run at 80 km/h and their acceleration responses are taken as the inputs to the profile inference algorithm. The results of this algorithm for vehicle 2 can be seen in Figure 3; similar results were obtained for all 6 vehicle models. For each profile, the algorithm determines the road profile in the left and right wheel paths, capturing both the short and long wavelength components to a high degree of accuracy. This suggests that irregularities such as potholes could be detected with ease using this method of identification. There is a gradual drifting effect to the estimated road profile in some cases, increasing with distance from the start point. This is an unavoidable effect associated with a build up of errors in the estimation of the target accelerations over distance. Figure 4 shows the results of correcting for this drift effect for all vehicles on profile AR5 which has the largest noticeable drift. Every ten metres along the profile, the 1m mean error between estimated and actual profile is calculated and the next ten metres of road profile is corrected using this. This correction is only used to illustrate the accuracy of the algorithm in estimating the high frequency irregularities of the profile despite the presence of gradual drift.

The power spectral densities (PSDs) of the actual and inferred left wheel path profile heights for each of the six vehicles are shown in Figure 5 for profiles AR2 and AR5. Similar levels of accuracy are obtained for AR1, AR3, AR4 and the right wheel path of each profile. While good agreement is obtained overall for the six estimated profiles, there are some slight differences between the PSDs obtained for each vehicle. Irrespective of this, the main differences apparent for these PSDs occur in the far right ends of the spectrum.

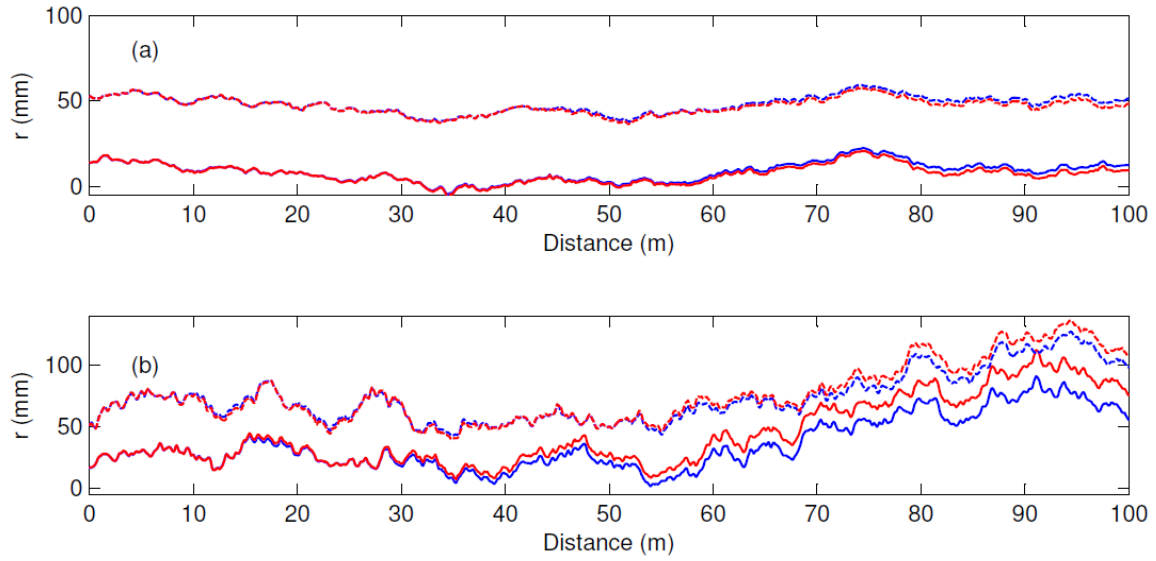

Figure 3 Actual (—) and estimated (—) road profiles from vehicle 2; left wheel path and right wheel path (offset by +40mm for clarity); (a) AR2 (b) AR5

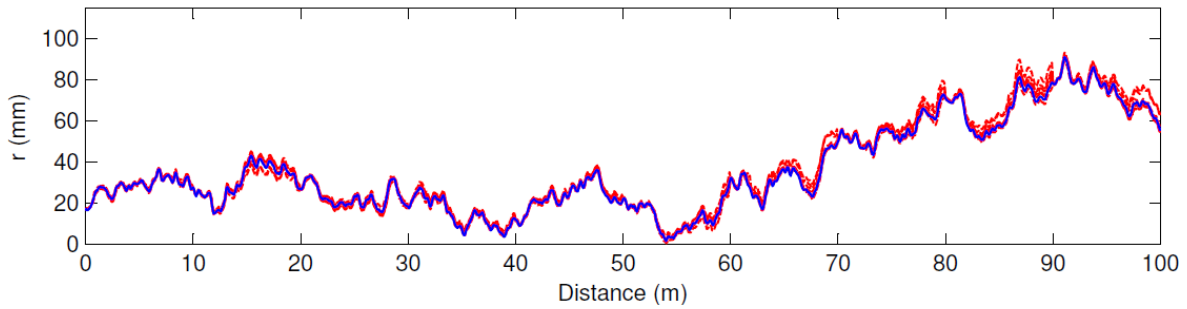

Figure 4 Actual (—) and corrected inferred (---) road profiles for left wheel path of AR5 for all vehicles

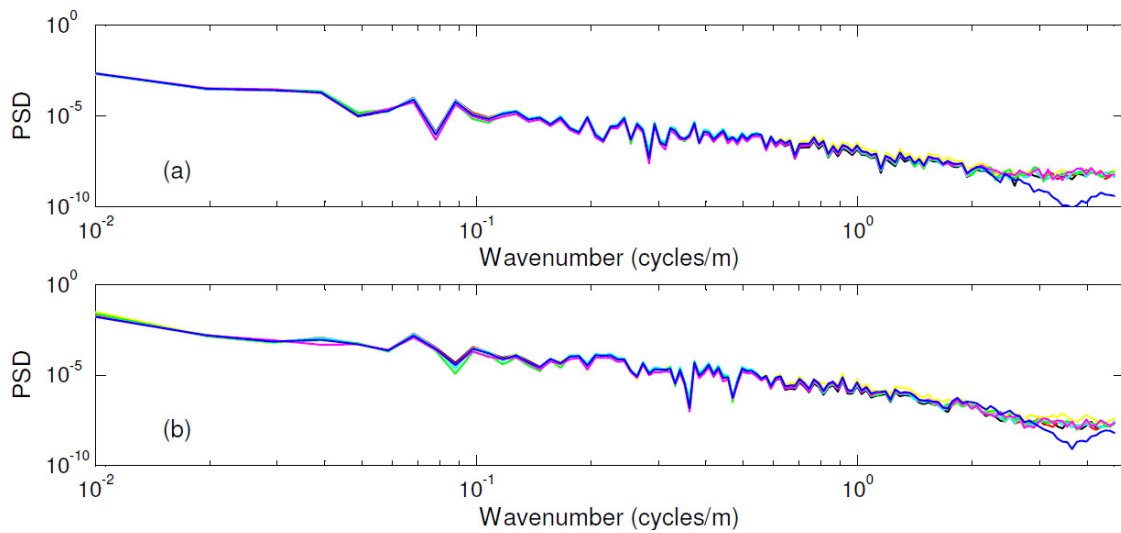

Figure 5 Power Spectral Densities of actual (—) and inferred left wheel path road profiles for all vehicles; (a) AR2 (b) AR5

3.1 IRI Ratings for Estimated Profiles

The IRI rating of each inferred profile is calculated and compared to the original road profile ratings. It is found that the IRI ratings obtained for an individual profile differ between vehicles and this highlights the fact that the error in IRI rating is dependent on the vehicle model, not the roughness of the profile being estimated. The mean error of estimating the IRI rating for all five road profiles is shown in Table 3 for each vehicle. Some of these errors are high despite the accuracy of the PSDs. However, if the mean IRI rating of all vehicle results for a single profile is taken, an accurate rating is obtained. It can be seen in Table 4 that averaging the estimated rating for each profile over all six vehicles gives values with errors predominantly under 1% when compared to the actual IRI ratings in Table 2.

Table 3 Mean error in IRI rating estimation for each vehicle

Vehicle	Mean IRI _{left} Estimation Error (%)	Mean IRI _{right} Estimation Error (%)
1	-1.28	-2.54
2	3.06	2.32
3	5.44	7.46
4	8.15	5.21
5	-2.44	-5.01
6	-12.85	-7.74

Table 4 Comparison of mean estimated and true IRI Ratings

Profile	IRI _{left} (m/km)		IRI _{right} (m/km)	
	Estimated	Error (%)	Estimated	Error (%)
AR1	1.48	0.11	1.46	-0.68
AR2	2.27	0.07	2.13	1.51
AR3	3.10	0.16	2.96	0.23
AR4	6.18	-0.16	6.24	-0.72
AR5	8.55	-0.12	8.22	-0.58

3.2 Influence of Noise on Accuracy of the Algorithm

The influence of noise on the accuracy of the road profile inference algorithm is investigated for vehicle 1. The input half car accelerations for profiles AR2 and AR5 are corrupted using an additive noise model and analysed for signal to noise ratios (SNR's) of 20 and 10. With this model, noise is randomly added to the true accelerations by sampling a normal distribution of zero mean and standard deviation equal to the standard deviation of the true acceleration data divided by the signal to noise ratio. Figure 6 shows the corresponding actual, noise-free estimated and that inferred using noisy data. The accuracy is similar to that obtained for the uncorrupted data and also there is good agreement between SNR 20 results and SNR 10 results for short wavelength irregularities. This suggests that the accuracy of the algorithm is more dependent on vehicle parameters than the level of noise in the corrupted accelerations. It is of note, however, that the gradual drifting effect which was seen for the original estimated road

profiles increases with noise and higher road roughness. Figure 7 shows the corresponding PSDs of road profile heights for the left wheel path.

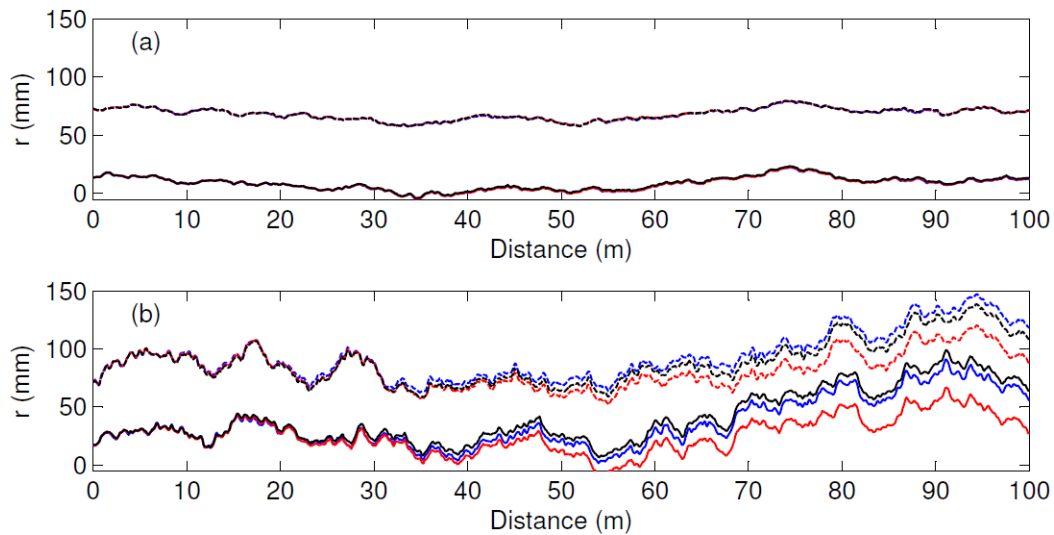

Figure 6 Actual (—) and estimated with noise (SNR=20 - -; SNR=10 - -) road profiles for vehicle 1; left wheel path and right wheel path (offset by +60mm for clarity); (a) AR2 (b) AR5

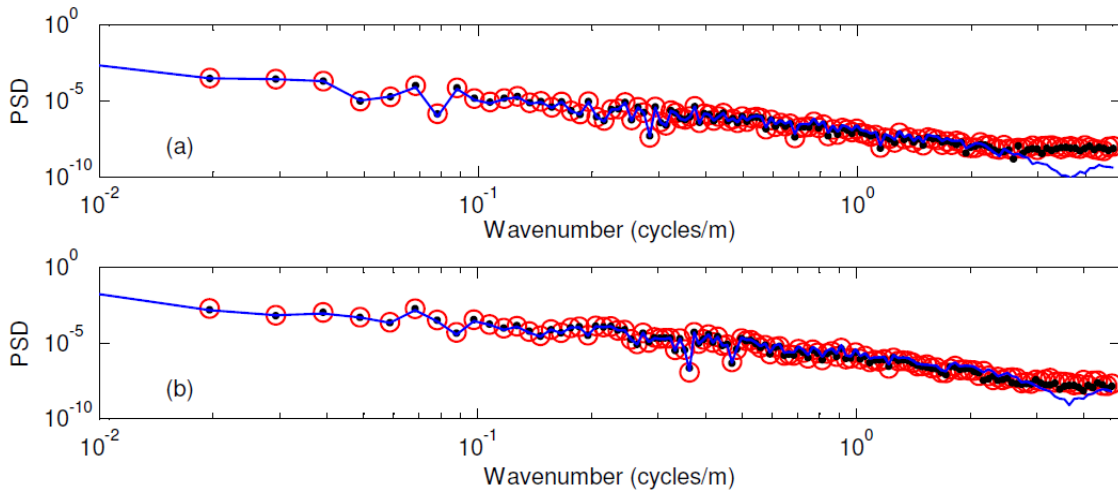

Figure 7 PSDs of actual (—), estimated with noise (SNR10 ···, SNR20 ○○○) left wheel path road profiles for vehicle 1; (a) AR2 (b) AR5

4. Conclusion

A novel method for the periodic monitoring of pavement condition using measurements of vehicle acceleration response has been described. The method proposes the collection of information on the road profile via accelerometers mounted in a fleet of non-specialist vehicles, such as police cars. It proposes an alternative algorithm, based on Cross Entropy theory, to predict road irregularities. A half-roll vehicle model was used to test the algorithm for six representative vehicles and five generated road profiles. Results show that the algorithm estimates the road profile irregularities quite accurately for each vehicle. Optimal accuracy in IRI

rating is achieved by taking the mean value of all six vehicles for each individual road profile, with the obtained IRI values consistently within $\pm 2\%$ of the reference values. The main errors in the estimated profiles are generally limited to frequencies which do not have a large influence on the vehicle model responses, such as short wavelength, high frequency errors and long wavelength errors due to drift. The addition of low levels of noise to the simulated accelerations has not affected the accuracy of the profile irregularity identification significantly; the accuracy is more dependent on the vehicle parameters. However, the level of noise does affect the amount of drift occurring in the profile irregularity identification. Overall the approach is feasible and it has been shown that despite variability between vehicles in a fleet used to collect the data, good estimates of the short-wavelength features of the road profile can be detected.

5. Acknowledgements

The authors wish to acknowledge the support received from the European 7th Framework project ASSET (Advanced Safety and driver Support in Efficient road Transport).

6. References

1. Dynamic interaction of heavy vehicles with roads and bridges (1997). Technical report, OECD, Ottawa, Canada. DIVINE Concluding Conference.
2. Gillespie, T.D., Karamihas, S.M., Cebon D., Sayers M.W., Nasim M.A., Hansen, W. and Ehsan, N. (1992). 'Effects of heavy vehicle characteristics on p response and performance', University of Michigan Transportation Research Institute, UMTRI-92-2.
3. Green, M.F. and Cebon, D. (1994). 'Dynamic responses of highway bridges to heavy vehicle loads, theory and experimental validation', *Journal of Sound and Vibration*, Vol. 170, No. 1, pp. 51-78.
4. Sayers, M.W. and Karamihas, S.M. (1996). 'Interpretation of road profile roughness data', University of Michigan Transportation Research Institute, UMTRI-96-19.
5. Sayers, M.W. and Karamihas, S.M. (1998). 'The little book of profiling', University of Michigan Transportation Research Institute, UMTRI-96-19.
6. González, A., OBrien, E.J., Li, Y.-Y., Cashell, K. (2008). 'The use of vehicle acceleration measurements to estimate road roughness', *Vehicle System Dynamics*, Vol. 46, No. 6, pp. 483-499.
7. Harris, N.K., González, A., OBrien, E.J., McGetrick, P. (2009). 'Characterisation of pavement profile heights using accelerometer readings and a combinatorial optimisation technique', *Journal of Sound and Vibration*, Accepted for Publication.
8. De Boer, P.T., Kroese, D.P., Mannor, S., Rubinstein, R.Y. (2005). 'A Tutorial on the Cross-Entropy Method', *Annals of Operations Research*, Vol. 134, No. 1, pp. 19-67.
9. Belay, A., OBrien, E.J., Kroese, D. (2008). 'Truck fleet model for design and assessment of flexible pavements', *Journal of Sound & Vibration*, Vol. 311, No. 3-5, pp. 1161-1174.
10. International Organization for Standardization ISO 8608 (1995). Mechanical vibration - road surface profiles - reporting of measured data.
11. Chang, G.K., Dick, J.C. and Rasmussen, R.O. (2006). *ProVAL Users guide*. The Transtec Group, Inc.