



Title	Effect of energy harvesting network reactive support on transmission system voltage performance
Authors(s)	Cuffe, Paul, Smith, Paul, Keane, Andrew
Publication date	2011-06
Publication information	Cuffe, Paul, Paul Smith, and Andrew Keane. "Effect of Energy Harvesting Network Reactive Support on Transmission System Voltage Performance." CIRED, 2011.
Conference details	Paper presented at the 21st International Conference on Electricity Distribution, Frankfurt, June, 6-9, 2011
Publisher	CIRED
Item record/more information	http://hdl.handle.net/10197/3303
Publisher's statement	This paper was presented during the 21ST International Conference on Electricity Distribution (CIRED 2011) held in Frankfurt on 6-10 June 2011.

Downloaded 2024-04-18 16:55:09

The UCD community has made this article openly available. Please share how this access benefits you. Your story matters! (@ucd_oa)



© Some rights reserved. For more information

EFFECT OF ENERGY HARVESTING NETWORK REACTIVE SUPPORT ON TRANSMISSION SYSTEM VOLTAGE PERFORMANCE

Paul CUFFE

University College Dublin - Ireland
paul.cuffe@ucd.ie

Paul SMITH

University College Dublin - Ireland
paul.f.smith@ucd.ie

Andrew KEANE

University College Dublin - Ireland
andrew.keane@ucd.ie

ABSTRACT

It is common to operate distributed generators (DGs) at fixed inductive power factors to overcome voltage rise constraints on distribution networks. This approach increases distribution system reactive power demand, which may strain transmission system reactive power resources at times of system-wide high DG output, particularly if such output displaces synchronous generators. If a number of adjacent DGs are connected to a transmission node in a clustered fashion via a dedicated energy harvesting network (EHN), it is possible to characterise their aggregated reactive power capability as a form of virtual power plant. Such a characterisation will be provided in this paper. The aggregated capability may readily be included in transmission system models. This work will explicitly compare the transmission system voltage-control performance of EHN reactive capability with that of traditional synchronous plant.

INTRODUCTION

Increasing renewable penetration levels necessitate that renewable generators be considered as vital participants in the provision of ancillary services to the broader power system. Doubly fed induction generators (DFIGs), whose power electronics permit control of reactive power output largely independently of active power output, are well suited to participate in power system voltage support.

The literature is replete with active control strategies for the optimal employment of reactive power resources spread throughout a distribution system [1] [2] [3]

A different control approach can be adopted for clusters of adjacent generators, which may be connected in a grouped fashion to a dedicated transmission node for economic reasons.

Previous work [4] has established that the reactive power capability of an EHN composed of DFIG wind farms can be characterised by numerical and statistical means, to give an aggregated reactive capability available at the transmission node. This method is concerned with establishing the reactive power operating limits offered by a particular network; the implementation of a suitable control scheme to realise it is not considered. This aggregated EHN capability is an analogue to the capability chart used to characterise synchronous plant. This work will demonstrate how this aggregated capability can be used for transmission system studies.

Some initial results giving a direct comparison of EHNs'

and synchronous plants' effect on transmission system voltage performance will be provided. To this end, the two generator types are considered under the same active power dispatch regime. This, of course, is an entirely unrealistic assumption given the stochastic nature of wind power production. However, by holding such factors constant, a *ceteris paribus* comparison will isolate the effect of the altered reactive power operational envelope on transmission system voltage performance.

METHODOLOGY

The following steps were followed to produce a body of comparative results

1. Development of EHN reactive power characteristics as equivalents to each generator in the test system
2. Generator active power dispatch of the test system for use in time series load-flow analysis
3. Incremental substitution of synchronous machine capability chart with equivalent EHN capability and recording of resultant effect on transmission system voltage.

TEST SYSTEM SELECTION

The authors selected the IEEE 30 bus test system as being suitable for the purposes of this work based on its use for many similar studies (i.e [5]) The network is composed of 8 transmission buses operated at 132 kV, as well as a distribution system which connects load at 33 kV. The system characteristics are as given in [6], which also provides the generator parameters used as the basis for this study. This table shows generator operation limits, as well as the merit order imposed by the authors to produce a rudimentary system dispatch in the face of varying load.

Table 1: Test system generator parameters

Gen.bus	P_{\min} (MW)	P_{\max} (MW)	New P_{\max} (MW)	Merit
Gen1	0	200	200	6
Gen2	20	80	75.5	1
Gen5	15	50	47.5	2
Gen8	10	35	33.5	4
Gen11	10	30	28.5	5
Gen13	12	40	38.5	3

The "New P_{\max} " column shows the slight attenuation of generator maximum output limits imposed for this study. This is a consequence of the method used to produce

EHN capability characteristics; the EHN simulated to match Gen2 was composed of windfarms with an aggregate maximum export capacity of 80 MW; the diminishment of this figure reflects active power losses within the EHN.

The six generators supply a peak load on the system of 283.4 MW and 126.2 MVar. The active and reactive loads in the system are scaled by a normalised system load curve taken from the Irish system. The time-series load data is at a resolution of fifteen minutes, and is taken from the year 2009.

As the level of reactive power provision from generators is central to the comparisons to be given in this work, it was vital to impose a realistic reactive power capability on the synchronous generators within the IEEE 30 bus system. To this end, the model was augmented with generator step-up transformers for synchronous generators 2, 5 and 8. These are sized in MVA for a 0.85 power factor operation at rated active power, and step up the voltage from 11 kV to 132 kV, with an impedance of 10.08% and an X/R ratio of 26. Generators 11 and 13 are connected through the three-winding transformer equivalent impedances given in the original system [6], and they regulate the voltage at transmission buses 6 and 4 respectively. All generators are set to control the voltage at their transmission system connection bus to 1 pu.

GENERATOR REACTIVE CAPABILITY CHARACTERISATION

Each generator is modelled with either a typical synchronous machine operating chart or with a representative capability from a model EHN.

The operating chart for synchronous machine is based on synchronous reactances of $X_d = X_q = 1.75$ pu. (7) Generator power factor is rated at 0.85. Inclusion of unit transformers accounts for the attenuation of reactive capability available at the transmission level.

To produce EHN reactive capability characterisations the method given in [4] is adopted, whereby empirical time series power output data for the wind farms comprising the EHN is used to produce a set of realistic network operating points.

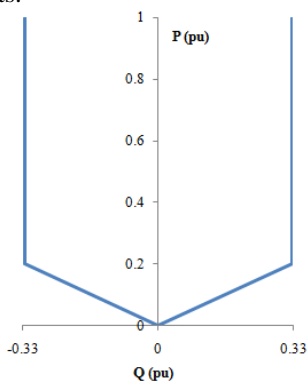

Figure 1: Assumed reactive power capability of each DFIG DG within the EHN.

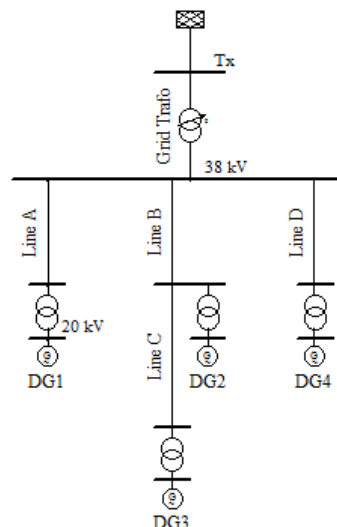

Figure 2: Model EHN used in this study.

The four DGs shown in figure 1 are simulated with fifteen minute output data from four existing adjacent windfarms in the Republic of Ireland. The impedances of the lines connecting them within this EHN are consistent with their actual geographic disposition. Each farm is modelled as a DFIG generator, per figure 1, behind an appropriately sized grid interface transformer.

For each fifteen minute snapshot simulation, the active and reactive power flow (P, Q) at the transmission node in figure 1 is recorded. These recordings form the basis for the statistical analysis. In figure 3, a cloud of such operating points is plotted in blue. The characterisation for this study used 30, 000 historical active power outputs for the four DGs shown in figure 1.

The limits of reactive power export or import at a given aggregate P output depend on a number of factors: the reactive capabilities of each constituent generator, the impedances within the harvesting network, the prevailing disposition of active power injections and the voltage profile within the EHN. The variation in active power injection profiles affects reactive power (I^2X) losses within the network as well as the prevailing voltage profile, meaning that the reactive power capability envelope may not be tightly deterministic with respect to aggregate active power. To find the set of reactive support maximisation operating points, in each load flow snap-shop, each DG exports its maximum reactive power, unless curtailed by an over voltage condition. The set of reactive absorption points is produced using the inverse procedure.

To find an EHN equivalent for each generator in the 30 bus system, the capacity of each DG in the model EHN is proportionately scaled so that their sum equals the original P_{max} stipulated for that generator. Transformers within the EHN are also scaled appropriately to accommodate the new aggregate capacity. The EHN model thus produced is used for the time series simulations previously described.

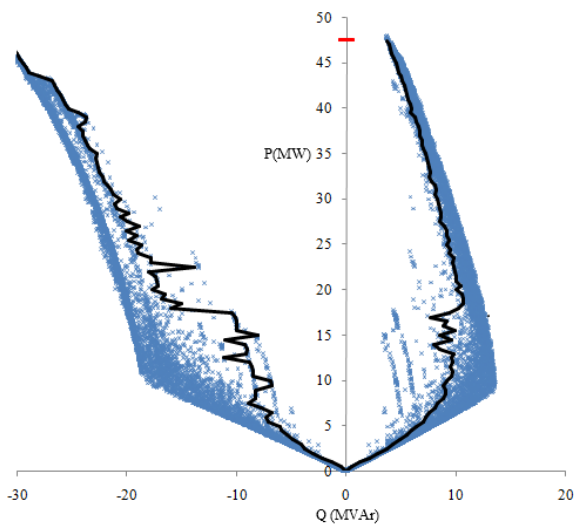

Figure 3: Results from the EHN characterisation process used for Gen5.

The black lines in figure 3 delineate the region within which just 1% of the operating points lie. The authors selected this arbitrary value to allow the massive set of operating points be reduced to a more tenable characteristic. Future work may establish more rationale grounds for selection of this figure. The capability these black lines describe is achievable 99% of the time. These lines characterise the EHN for modelling as a PV generator. The attenuation of available reactive power reserves at high active power outputs is typical of an EHN, due to I^2X losses as well as voltage constraints.

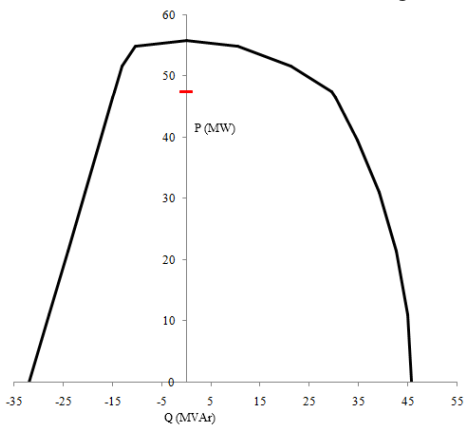

Figure 4: Reactive capability, exclusive of unit transformer losses, available to Gen5 when it is modelled as a synchronous machine

The capability chart given in figure 4 is provided for comparison with figure 3. Synchronous plant enjoys much greater reactive power capability than the EHN family modelled for this work. The capability of an EHN depends on a range of network, generator and environmental variables; the specimens considered in this work are merely examples which may provide illustrative insight.

TEST SYSTEM OPERATION

Two periods of approximately a month each were selected; a Winter period bracketing the maximum system demand of 283.4 MW, and a Summer period containing the minimum demand of 96.4 MW. Time series load flow analysis was performed with a granularity of fifteen minutes. Generator dispatch was updated for each fifteen minute loading condition, according to the merit order given in Table 1. Generators were never decommitted, but were instead ramped down to their minimum load level.

For each time period, six separate time series load flow analyses were performed .

- The initial time series simulation modelled all generators as synchronous plant
- For the next analysis, the highest merit generator had its synchronous capability chart replaced with an EHN equivalent
- The time series analysis was repeated under the same dispatch and loading regime
- By the sixth time series analysis, all generators except the slack Gen1 will be operating as EHNs

RESULTS

Winter Period

Load levels over this period are high, and generators operate at high capacity factors.

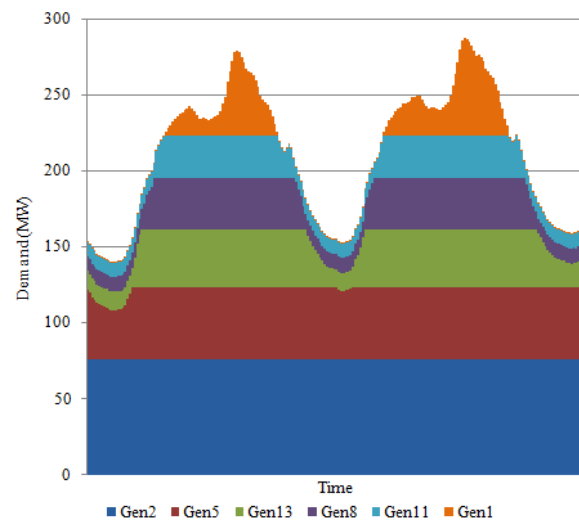

Figure 5: An example of system dispatch for two "Winter" weekdays

For a broad assessment of transmission system voltage performance with increasing EHN penetration, we first examine some broad metrics of global transmission system health:

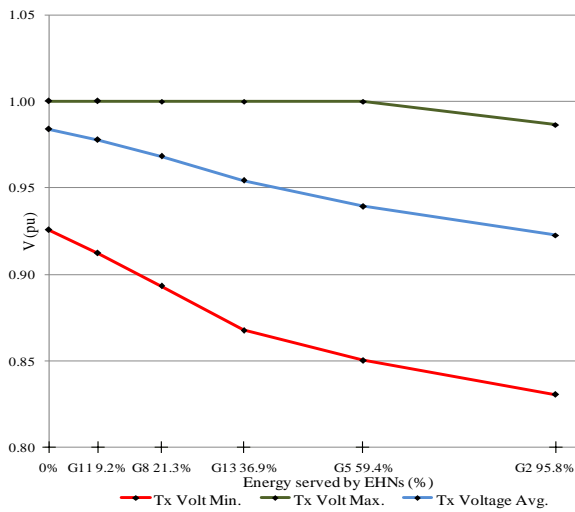

Figure 6: The descent in average and minimum transmission system voltages as EHN penetration increases.

For each of the six simulation cases, figure 6 plots three simple metrics of transmission system health. It gives the absolute maximum and minimum voltage recorded at any transmission bus at any point in the time series analysis. The average of all transmission bus voltages over the time series is also given (Voltages at the slack bus, 1, are excluded from this analysis) The x-axis provides the prevailing energy penetration of EHN generators for each simulation case, as well as naming the incremental generator to receive an EHN characterisation.

The general lowering of transmission voltages shown here is the anticipated effect of the diminishment of transmission system reactive power reserves caused by the replacement of synchronous capability. To analyse each individual generator's contribution to reactive power provisions in the face of increasing EHN penetration, we consider the following graph of reactive power production integrated over time:

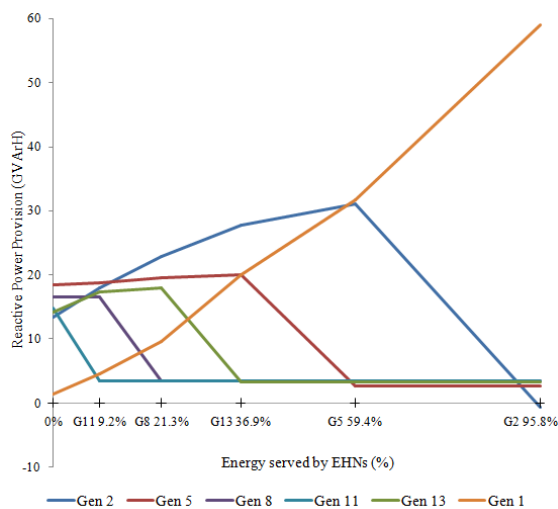

Figure 7: Contribution to reactive provision by individual generators in each simulation case

It is immediately clear that as each generator is replaced by an equivalent EHN its provision of reactive power to the transmission system is reduced to approximately one fifth of its peak synchronous contribution. That is, the trace for a particular generator reduces to low equilibrium once it has been given an EHN capability.

In the final simulation case on the extreme right, we observe that the baseloaded Gen2 actually necessitates reactive power import when operating as an EHN. This is to overcome internal voltage constraints encountered at its maximum active power export.

As the system is heavily loaded over the "Winter" period, generators typically operate at high active power outputs levels, where EHN losses and voltage constraints severely hamper the level of reactive power available (as evinced in Fig 3) Comparison with the "Summer" period will establish how relevant this operational aspect is.

The shortfall in reactive power caused by increasing EHN penetration is made good by Gen2 and the slack bus at Gen1. This entails the transmission of reactive power to buses electrically remote from the supplying generator, harming voltage levels as seen in figure 7. In practice, the over-reliance on Gen1 for reactive support would cause serious concerns over voltage security at the higher (perhaps >21.8%) penetration levels of EHNs.

Summer Period

The active power regime for the Summer period has more of the generators operating over a greater range of output powers. This may facilitate greater reactive support from EHN generators, whose reactive capabilities are sharply curtailed at high active power output.

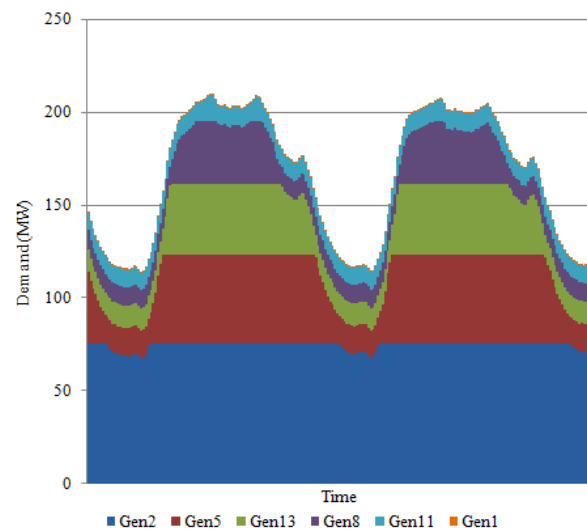

Figure 8: Two sample "Summer" weekdays demonstrate generator dispatch

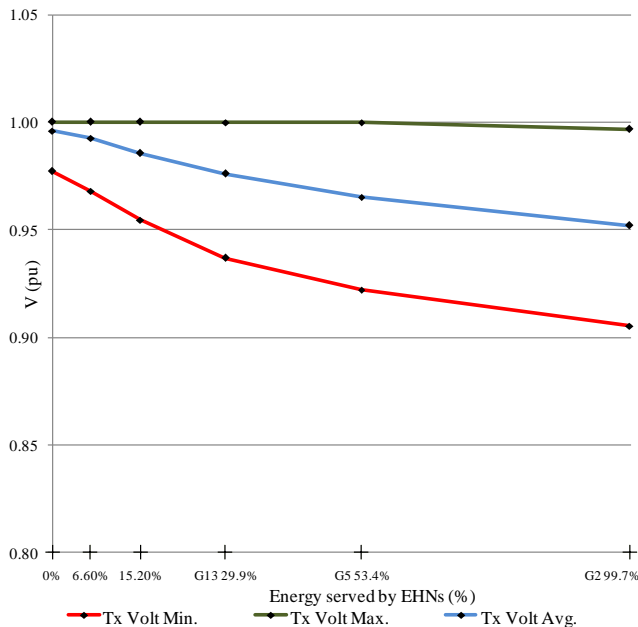

Figure 9: Transmission voltage metrics with increasing EHN penetration

As expected, for the lightly loaded "Summer" period, transmission system voltage levels are much improved over the "Winter" case, even at high penetration levels of EHNs.

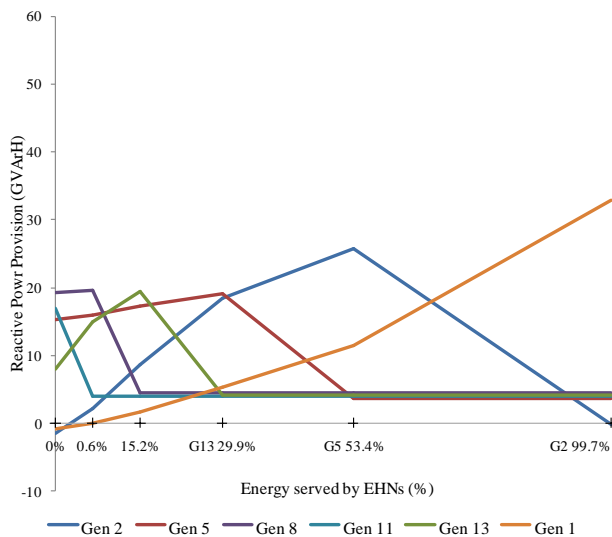

Figure 10: Time integrated reactive power contribution from each generator for the six penetration levels.

We note that the reliance on Gen1 is reduced in this case, as its provision of GVArH does not rise so sharply with the increase in EHN penetration. Notably, reactive support from generators operating as EHNs still shows a marked reduction on peak synchronous performance. Even with the more favourable dispatch regime given in figure 8, the reactive support available from EHNs is still dwarfed by that available from synchronous plant. This is a direct consequence of the considerable difference in the

capabilities shown in figures 4 and 3, the latter derived from the fundamental DG capability given in figure 2.

CONCLUSIONS

The use of encapsulated reactive power capabilities for a cluster of DGs allows for a streamlined approach to transmission system modelling.

The transmission system results show a marked degradation in voltage performance under significant EHN penetration. Though the voltage support contribution of the EHNs considered in this work may be modest, it is preferable to the passive, reactive consumption of fixed inductive DGs.

REFERENCES

- [1] Keane, A.; Ochoa, L. F.; Vittal, E.; Dent, C. J.; Harrison, G. P.; , "Enhanced Utilization of Voltage Control Resources With Distributed Generation," *Power Systems, IEEE Transactions on*, vol.PP, no.99, January 2010
- [2] Senjyu, T.; Miyazato, Y.; Yona, A.; Urasaki, N.; Funabashi, T.; , "Optimal Distribution Voltage Control and Coordination With Distributed Generation," *Power Delivery, IEEE Transactions on* , vol.23, no.2 April 2008
- [3] Gubina, A. F.; Gubina, F.; Golob, R.; "Intelligent coordinative voltage and reactive power control" *International Journal of Electrical Power & Energy Systems*, May 2001
- [4] Cuffe, P.; Smith, P.; Keane, A.; , "Analysis of the Voltage Control Capability of Energy Harvesting Networks", *9th International Workshop on large Scale Wind Integration*, Quebec, Canada, October 2010
- [5] Meegahapola, L.; Durairaj, S.; Flynn, D.; Fox, B.; " Coordinated utilisation of wind farm reactive power capability for system loss optimisation", *European Transactions on Electrical Power*, March 2010
- [6] Alsac, O.; Stott, B.; , "Optimal Load Flow with Steady-State Security," *Power Apparatus and Systems, IEEE Transactions on* , May 1974
- [7] P. Kundur, *Power System Stability and Control*, London, UK, McGraw-Hill, 1994