



Title	Truck fleet model for design and assessment of flexible pavements
Authors(s)	Belay, Abraham, O'Brien, Eugene J., Kroese, Dirk P.
Publication date	2008-04
Publication information	Belay, Abraham, Eugene J. O'Brien, and Dirk P. Kroese. "Truck Fleet Model for Design and Assessment of Flexible Pavements" 311, no. 3-5 (April, 2008).
Publisher	Elsevier
Item record/more information	http://hdl.handle.net/10197/2336
Publisher's statement	All rights reserved
Publisher's version (DOI)	10.1016/j.jsv.2007.10.019

Downloaded 2023-03-15T17:09:45Z

The UCD community has made this article openly available. Please share how this access benefits you. Your story matters! (@ucd_oa)



© Some rights reserved. For more information

Truck Fleet Model for Design and Assessment of Flexible Pavements

Abraham Belay¹, Eugene OBrien² and Dirk Kroese³

1. O'Connor Sutton Cronin & Ass., Consulting Engineers, formerly School of Architecture, Landscape and Civil Engineering, University College Dublin, Dublin 4, Ireland; Tel: +353 87 767 6372; Fax: +353-1-716 7399; Email: abraham.belay@ucd.ie
2. UCD Urban Institute, University College Dublin, Dublin 4, Ireland; Tel: +353 1 716 2691; Fax: +353-1-716 2690; Email: eugene.obrien@ucd.ie
3. Department of Mathematics, The University of Queensland, Brisbane 4072, Tel: +61 7 3365 3287; Email: kroese@maths.uq.edu.au

Abstract

The mechanistic empirical method of flexible pavement design/assessment uses a large number of numerical truck model runs to predict a history of dynamic load. The pattern of dynamic load distribution along the pavement is a key factor in the design/ assessment of flexible pavement. While this can be measured in particular cases, there are no reliable methods of predicting the mean pattern for typical traffic conditions. A simple linear quarter car model is developed here which aims to reproduce the mean and variance of dynamic loading of the truck fleet at a given site. This probabilistic model reflects the range and frequency of the different heavy trucks on the road and their dynamic properties. Multiple Sensor Weigh-in-Motion data can be used to calibrate the model. Truck properties such as suspension stiffness, suspension damping, sprung mass, unsprung mass and tyre stiffness are represented as randomly varying parameters in the fleet model. It is used to predict the statistical distribution of dynamic load at each measurement point. The concept is demonstrated by using a pre-defined truck fleet to calculate a pattern of statistical spatial repeatability and is tested by using that pattern to find the truck statistical properties that generated it.

Keywords: Multiple Sensor, Weigh in Motion, WIM, Spatial repeatability, dynamic load, fleet model, probabilistic, statistical, mechanistic empirical.

1. Introduction

The AASHTO Guide for the design of pavement structures is commonly used to design pavements with traffic loadings greater than 50 million equivalent axle loads (ESALs) [1]. It is assumed that each point is subjected to forces that are statistically similar to all other points and hence that the probability of deterioration is uniformly distributed along the pavement. This is clearly untrue given the phenomenon of spatial repeatability – it is known that some points on a road are subjected on average to greater forces than others. The phenomenon is illustrated in Figure 1 which shows the mean pattern of measured dynamic forces on a short stretch of road near Arnheim in the Netherlands. Three patterns are illustrated, each representing the mean force applied by the third axle of one thousand 5-axle trucks. The similarity of the three patterns confirms the phenomenon of spatial repeatability in the truck fleet. Cole et al. [2] found similar results by measuring dynamic force generated by 1500 heavy vehicles using a mat containing 144 capacitive strip sensors. O'Connor et al. [3] report similar results from WIM data, demonstrating a pattern of spatial and statistical spatial repeatability of dynamic force. Ullidtz [4] and Collop et al. [5] have shown that it is this dynamic force that should be used in the Mechanistic Empirical (ME) approach to predict the life of a flexible pavement. The clustering of high forces at particular points along a road pavement (Figure 1) leads to a tendency of increased pavement damage at those points.

The ME method requires a prediction of the actual distribution of dynamic load caused by the fleet of trucks that travels on that section of the road Collop et al. [6]. Furthermore, the predicted mean pattern of dynamic force needs to be recalculated periodically as pavement damage causes the road profile to change. DePont [7] used dynamic vehicle models in an attempt to generate the mean patterns of dynamic force measured in the data of [3]. However, he used a stochastic road profile so it is not surprising that he did not get a good match to the measured mean patterns. Cole and Cebon [8] also tried to reproduce patterns of spatial repeatability but did not allow for the variability in the vehicle dynamic properties. This paper describes a computer model which predicts the dynamic behaviour of a truck fleet. The goal is to use this model to predict patterns of spatial repeatability on a

road with a given profile. This in turn can be used to accurately predict pavement life.

The truck fleet model differs from a conventional truck dynamic model in that many runs are carried out with different combinations of vehicle properties in each run, reflecting variations between individual trucks on the road. The model allows for statistical variation in the vehicle properties such as suspension stiffness, suspension damping, sprung mass, unsprung mass and tyre stiffness. The outputs are statistical distributions of dynamic force at each point which can be used to predict pavement remaining life.

Models which predict pavement wear in response to dynamic forces have been proposed by a number of researchers. Eisenmann for example [9], applies the fourth power law to a random Gaussian distribution of wheel forces but with no spatial repeatability. More recently, some researchers [10,11] have made allowance for spatial differences in the dynamic force in pavement deterioration models.

Wilson et al. [12] have used Bayesian Updating to find the statistical distributions for a truck fleet model when applied dynamic forces are known, as would be the case with a dynamically calibrated multiple-sensor weigh-in-motion system. This paper solves the same problem but with a more direct approach which provides insights into the sensitivity of the force patterns to variations in fleet properties. Here the distributions of properties for the fleet are found by minimising the sum of squares of differences between the theoretical and statistical measurements of the forces. Many optimisation methods are based on gradient or pseudo-gradient techniques. The drawback of optimisation techniques such as Gradient Descent, Newton-Type Methods, Variable Metric, Conjugate Gradient etc. are that in their nature, they do not cope well with problems that have non-convex objective functions and/or many local optima. There are many applications of multi-extremal continuous optimisation problems. A popular and convenient approach to these problems is to systematically partition the feasible region into smaller sub-regions and then to move from one optimum to another, based on information obtained by random search.

The optimization problem described here is particularly difficult. It is required to find the statistical parameters which describe the distribution of the dynamic properties of the truck fleet. Each trial truck fleet is defined by statistical parameters such as mean and standard deviation of suspension stiffness, suspension damping, tyre stiffness, sprung mass and unsprung mass. What makes this problem different is that the sum of squares of differences refers to the statistical distributions of forces from the fleet of trucks rather than the forces from an individual truck. Using Monte Carlo simulation to generate such distributions means that there are random variations in each evaluation of the objective function at a point. Optimization methods that may be suitable for such an ill conditioned problem include simulated annealing, threshold acceptance, genetic algorithms, colony method and the stochastic comparison method [13-17].

The Cross Entropy (CE) method of optimisation [Appendix I, 18] is used in this paper as it considers a generation of alternative solutions simultaneously and is therefore insensitive to the ‘noisiness’ of the problem. The generations of solutions for the statistical parameters converge to optimal or near-optimal solutions. For a simulated example, it is shown that CE can successfully find truck fleet statistical parameters which give a good match to targeted patterns of dynamic force on a pavement.

2. Vehicle Model

O’Connor et al. [3] have identified the principle of statistical spatial repeatability for mean patterns of impact factor for a large number of trucks. Further, they have shown that the mean pattern is reasonably consistent for trucks with different numbers of axles. It is therefore assumed here that such a pattern can be captured with a simple uniaxial truck fleet model. A two-degree-of-freedom quarter car model [19-24] (Figure 2) is used in this paper. In this model, the unsprung mass (representing the mass of the wheels and axle) and sprung mass (representing part of the mass of the vehicle body) are denoted as m_u and m_s respectively. The suspension system is represented by a linear spring of stiffness k_s and a linear damper c_s , while the tyre is modelled by a linear spring of stiffness k_t and the road input irregularities are given by y_r .

The quarter car model does not include suspension nonlinearities, interaction between axles of the truck, or roll and pitch motions of axles and sprung masses. Nonetheless, Cebon [23] noted that the majority of single axle suspensions in current use can be broadly represented by this model.

The equations of motion controlling this suspension system are given by the differential equations:

$$m_s \ddot{y}_u = k_s (y_u - y_s) + c_s (\dot{y}_u - \dot{y}_s) \quad (1)$$

$$m_u \ddot{y}_u = -k_s (y_u - y_s) - c_s (\dot{y}_u - \dot{y}_s) + k_t (y_r - y_u) \quad (2)$$

where y_u and y_s are the displacements of the unsprung and sprung masses respectively and \dot{y}_u , \dot{y}_s , \ddot{y}_u , \ddot{y}_s are the corresponding velocities and accelerations. The pavement profile is represented by the elevations, y_r , at 0.01m intervals.

Successive solutions of the unsprung deflections y_u allows calculation of the force (F_t) applied by the axle to the pavement for a given vehicle and road profile:

$$F_t = k_t (y_u - y_r) \quad (3)$$

Then the Impact Factor (IF) is calculated as this total force divided by the corresponding static weight.

2.1. Truck Fleet Model

For the truck fleet models described here, all the vehicle parameter properties are assumed to be Normally distributed [25]. Hence, each property illustrated in Figure 2 can be represented with just a mean and standard deviation: tyre stiffness, velocity, unsprung mass, sprung mass, suspension stiffness and suspension damping. Typical statistical parameters for truck fleet properties are given in Table 1 from [25-27]. Typical velocity distributions are taken from a statistical analysis of Weigh in Motion data collected from

highway A1 near Ressons in France [27].

2.2. Road Surface Profile

In this paper two types of road surface profile are used:

- Artificial profiles – profile 0 (good), illustrated in Figure 3, profile 3 (good) and profile 4 (poor),
- Real profiles measured in the Netherlands - profiles 1 and 2 (both good).

For the artificial profiles, the randomness of the road surface roughness is represented with a zero mean Gaussian isotropic random field in a (2 dimensional) spatial domain and becomes a normal stationary ergodic random process in the distance domain ([22]; [30-31]). The road profile, $y_r(x)$, is generated using a standard procedure as the sum of a series of harmonics:

$$y_r(x) = \sum_{i=1}^N \alpha_i \cos(2\pi w_i x + \phi_i) \quad (4)$$

where N is the total number of frequency terms used, ϕ_i is an independent random variable with uniform distribution in the range $[0:2\pi]$, α_i is the amplitude of the cosine wave, w_i is the frequency within the interval $[w_{min}, w_{max}]$ in which the power spectral density is defined and x is the distance. The parameters α_i and w_i are computed, respectively, from:

$$\alpha_i^2 = 4s_y(w_i)\Delta w \quad (5)$$

$$w_i = w_{min} + (i - \frac{1}{2})\Delta w; \quad i = 1, 2, 3, \dots, N \quad (6)$$

where

$$\Delta w = \frac{(w_{max} - w_{min})}{N} \quad (7)$$

and $s_y(w_i)$ is the Power Spectral Density (PSD) roughness in terms of wave number, i , which represents the spatial frequency [24]:

$$s_y(w_i) = \begin{cases} s_y(w_0) \left(\frac{w_i}{w_0} \right)^{-n_1} & w_i \leq w_0 \\ s_y(w_0) \left(\frac{w_i}{w_0} \right)^{-n_2} & w_i > w_0 \end{cases} \quad (8)$$

where w_0 is the discontinuity wave number and n_1 and n_2 define the slopes. According to [30] the discontinuity between two branches of the PSD happens at a wavelength of approximately 6.3m, which is $1/2\pi$ cycles/metre taken as the datum value for $s_y(w_0)$. For a given $s_y(w_0)$, a higher value of n_1 means a road with an increase in proportional roughness at the longer wavelengths. Once generated, the surface profile is kept deterministic for the optimisation process.

3. Fleet Model Properties

The optimisation problem is to find the mean and standard deviation of each vehicle property that gives a best fit between the predicted statistical distribution of dynamic force and that measured at an MS-WIM site. The dynamic force distribution is characterised here using the Cumulative Distribution Function (CDF) (or rank) and the optimisation problem is to find the truck fleet properties that generate CDF's as close as possible to the measured CDF's of dynamic force at each point.

The simple linear two-degree-of-freedom truck fleet model of Figure 2 is used to test the approach and the means and standard deviations of Table 1 which define the fleet. These are used with profile 0 (Figure 3) to generate artificial MS-WIM data. The optimisation method is applied to that data to “back-calculate” the distribution of vehicle properties. The results are then compared to the known test distributions. A six-sensor MS-WIM array is assumed with sensor interval of 1.5 m at locations 8m, 9.5m, 11m, 12.5m, 14m and 15.5 m along a fifty metre length of road profile. The truck model was run repeatedly, each time with different properties sampled from the test distributions using Monte Carlo simulation. Hence, CDF's for the dynamic forces were generated at each sensor location. These were deemed to be the “measured” CDF's. This “measured” data is considered as a target

function and optimisation problem is to find the truck fleet properties that give a best fit to it.

3.1. Dynamic force on Sensors and Impact Factor

It is felt by the authors that working with impact factors as opposed to total (static + dynamic) force, is misleading. Light axles tend to have a different pattern of spatial repeatability from heavy ones and the latter have a much more significant influence on the rate of pavement deterioration.

Figure 4 illustrates the repeatability of the mean and standard deviation of dynamic force applied by the simulated trucks. For small truck fleets there is considerable variability in the mean and standard deviation of force at a point due to the randomness in the Monte Carlo method. However, for truck fleets of 3000 or more in this example, the mean varies by less than 1% between runs and the standard deviation by less than 4%. To minimise the lack of repeatability in results, a fleet size of 10,000 trucks was chosen in this study.

Using profile 0 of Figure 3, a fleet of 10,000 trucks with the properties from Table 1 was run to determine distributions of dynamic force on the road. The CDF's of force are illustrated in Figure 5. For this example, Sensor 5 is subject to significantly greater forces making that location more susceptible to damage.

The differences in the CDF's at each sensor location is a function of the road roughness and the fleet properties, among other things. For this example, the variability is about 20% between sensors. This is reasonably consistent with rank. For example, the range in the 10,000th largest force (100% fractile) is 60.9 – 72.3 kN (18%), 1000th largest force (10% fractile) is 39.9 – 47.9 kN (20%) while the range in the 500th largest (5% fractile) is 38.3 – 46 .2 kN (21%).

3.2. Discretized Cumulative Distribution Function

The histograms of dynamic force are fitted to a range of statistical distributions and the maximum log-likelihood calculated in each case. The log-likelihood varies by sensor but is maximum or near-maximum for the Normal distribution in all cases – see for example, Figure 6. This is reasonably consistent with the findings of Sweatman [10] who reported that the distributions of dynamic force have a departure from normality but concluded that it is possible to assume it as a Normal distribution in the case of calculation of the stress factor.

However, to avoid the need for any assumption with regard to distribution, the dynamic force data is represented by its measured CDF in this study. The CDF of sensor forces is defined by 101 points from the distribution. Hence, of the 10,000 forces found by measurement or Monte Carlo simulation, 101 are deemed to represent the distribution, namely the 1st, 100th, 200th, 300th, etc... The CDF corresponding to the measurements is referred to here as the target CDF. Hence the optimisation problem is to find the truck fleet model which minimises the sum of squares of differences between target and model CDF's, i.e., the model which minimises the objective function:

$$Obj = \sum_{j=1}^s \sum_{i=1}^{101} (F_{ij}^T - F_{ij}^M)^2 \quad (9)$$

where s is the number of sensors, F^T is the target force and F^M is the model force.

4. Sensitivity of the vehicle parameters

The optimisation approach will only find the correct fleet model parameters if the applied forces are sensitive to these parameters. As an example, the CDF of force applied at Sensor 1 is plotted against mean sprung mass in Figure 7(a), while keeping all other fleet parameters constant. It can be seen that a $\pm 10\%$ variation in mean sprung mass results in a significant shift in the CDF (at the 90% fractile, a 10% fall in mean mass results in a fall of force from about 51 kN to 46 kN). This results in a smoothly varying objective function with a clear minimum. On the other hand, a $\pm 10\%$ change in the standard deviation of

sprung mass (Figure 7(b)) results in a small difference in the CDF of applied force. The result is a very “flat” and less smooth objective function with variations between successive evaluations and a risk of local minima.

The sensitivity of the objective function to $\pm 10\%$ variations in each of the ten fleet model parameters is summarised in Table 2. It can be seen that, for all parameters, the objective function is considerably more sensitive to means than to standard deviations. It should be noted that the patterns of spatial repeatability are quite sensitive to speed but the statistical spatial repeatability patterns considered allow for the variations of speed in the truck fleet.

5. Optimisation using CE method

The development of Multiple Sensor Weigh in Motion systems enables measurements to be taken of dynamic force at different locations along the pavement length. These systems are calibrated using instrumented trucks to ensure that the measurements are dynamic forces rather than estimates of static axle weight [31]. The CE method of optimisation is used in this paper for the back-calculation of the vehicle parameters. In general, target functions will be formed from the distribution of vehicle dynamic forces measured using MS-WIM systems. However, to test the accuracy of the optimisation method, an artificial truck fleet is used here to generate the target distributions. In this way, the true fleet properties are known and can be compared to the properties inferred by the algorithm.

The goal in the optimisation is to find the fleet properties which give a minimum sum of squares of differences from the target values. There are 101 differences for each sensor location giving a total of 606 such differences. The Cross Entropy method works with a population of alternative solutions, i.e., a population of alternative truck fleet properties. In each stage (generation) in the solution procedure, a population of 300 different truck fleets were considered and the objective functions compared. The range of truck fleet properties to be considered is controlled by initial mean population values and initial population

standard deviations. At the end of the first stage, the objective function is evaluated for each alternative fleet in the population and an elite subset, consisting of those with the highest 10% of objective function values, identified. The remaining 90% of solutions are discarded. The mean and standard deviation of each of the fleet parameters of the elite subset of 30 are then calculated and used to generate a new population. This process is repeated until the standard deviation becomes small. A number of restarts were found to be needed to prevent premature convergence to local minima. For each restart, the population standard deviations were reset while retaining the mean value.

In the optimisation process, some spurious fleet properties were generated despite using reasonably good initial estimates. When zero or negative truck fleet properties were generated, they were rejected and another trial generated. This could introduce a small bias in the way in which the process converges towards the solution but was found to be insignificant for the cases considered.

6. Results and Discussion

For the artificial road profile 0 (Figure 3), the truck fleet properties of Table 1 were used to generate the CDF's of dynamic force at each sensor location. These target CDF's were used to back-calculate the truck fleet properties using the same profile 0. The results are given in Table 3. The Cross Entropy method did not find the exact truck fleet properties but found reasonably good estimates which match the distributions of dynamic force quite well. Despite the inaccuracies in fleet properties, they give a good prediction of the pattern of statistical spatial repeatability for this road profile.

To determine if this method can be used to predict unknown patterns of spatial repeatability, a number of simulated results are compared for profiles 1 to 4. The pattern implied by the inferred fleet properties is compared to the pattern generated by the original (true) properties. For each of these four profiles, both sets of truck fleet properties given in Table 3, are used. The results are illustrated in Figure 8. It can be seen that the match is

good for 10%, 50% and 90% fractiles and considerably better than the fleet property results of Table 3 might suggest. While spatial repeatability is highly sensitive to truck properties, statistical spatial repeatability is clearly not sensitive to the *fleet* properties. While the properties found by optimisation are inaccurate by up to 20%, the predicted dynamic forces are quite accurate. For the poor road profile 4, where the pattern is considerably more pronounced and therefore more significant for pavement deterioration, the accuracy of the method is very good – the pattern is captured quite well both at the 50% and 90% fractiles levels.

Matching the truck fleet properties at a site characterises the truck fleet. This fleet model can then be used to predict patterns of spatial repeatability at other sites subject to similar traffic. This method can be used to predict the changes in the SSR pattern as the road profile changes due to degradation with time. This is a powerful tool can be used to forecast the service life of a pavement.

7. Conclusions

This paper addresses a fundamental issue for the prediction of the remaining life of a road pavement. A method is developed which utilises pavement forces, as would be measured from a multiple-sensor weigh-in-motion system, to back calculate the statistical properties of the truck fleet. The truck fleet model can then be used to calculate patterns of spatial repeatability for any given road profile, a critical part of a mechanistic empirical assessment of pavement life.

Previous empirical studies have shown that patterns of spatial repeatability are insensitive to the number of axles in the truck. Hence, a single axle model is used here to represent a typical axle of the fleet. For typical fleet statistical properties, spatial repeatability is shown to be strong – with little variation in mean dynamic force – for a fleet size in excess of about 3000. For a typical profile, the Cumulative Distribution Functions are presented for a series of successive points along the road. There is significant variation in the dynamic forces and

the differences are consistent by rank – 10% fractile forces vary from one point to another by about the same as the mean and), a higher value of n_1 means a road with an increase in proportional roughness at the longer wavelengths and, in contrast, a higher n_2 means a road with a decrease in proportional roughness at shorter wavelengths the 90% fractile forces. The histograms fit well to Normal statistical distributions.

The Cross Entropy method of optimisation is applied to the problem of finding the truck fleet properties. The method is tested using simulated weigh-in-motion data so that the exact answer would be known. Quite accurate values for the mean properties are found and reasonably accurate values for the standard deviations. Predictions of patterns of spatial repeatability for other road profiles are shown to be insensitive to the inaccuracies and good predictions were found in all cases considered.

Appendix 1 – Cross Entropy Method

Pioneered in 1997 by Rubinstein, the Cross Entropy (CE) method [18] has rapidly developed as a powerful technique for combinatorial optimisation. In this paper, it is applied to the optimisation problem of finding that combination of truck fleet parameters which generates Cumulative Distribution Functions (cdf's) of applied forces to the pavement which best fit known cdf's of these forces. The CE method is based on the development of a *population* of solutions to the problem and the improvement of the population in successive generations. It derives its name from the use of cross entropy minimisation principles for the updating of the parameters.

For the truck fleet problem, the 10 parameters being sought are the means and standard deviations of the vehicle properties. The CE population consists of an array of alternative combinations of the 10 parameters which describe the fleet, i.e., an array of alternative fleets. For the first generation, the array is generated randomly (see [18]). The dynamic simulation of the truck fleet is run for each individual fleet in the population. For each fleet, the objective function – in this case, goodness of fit of cdf's – is evaluated. The portion of the population, ρ , with the least values of objective function, is retained for the next

generation and the rest discarded. This 'elite' sub-population is used to generate new values of fleet properties to complete the next generation. The mean and standard deviation of each property in the elite sub-population is calculated and Monte Carlo simulation used to randomly generate new property values. Finally, the $(1 - \rho)$ new fleets are combined with the elite sub-population of ρ to form the next generation.

The process is repeated for a number of generations until it converges to a population with a very small sub-population standard deviation. It was found that there was a tendency for premature convergence to non-optimal solutions and this was countered by occasional resetting of the standard deviation to a larger value, a technique known as injection.

Unlike many conventional approaches to optimisation, the Cross Entropy method has the advantage of working with a population of solutions rather than a single one. This provides a good spread over a wide range of possible solutions, especially in the early stages of the problem. While the Genetic Algorithm also works with a population of solutions, that is better suited to discontinuous problems that are coded in binary or integer strings.

References

- [1] S. B. Seeds, *Flexible pavements design summary of state of the arts a2b03*, Committee on Flexible Pavement Design, Nichols Consulting Engineers, Reno, Nevada, TRB, 2002
- [2] D. J. Cole, T.E.C. Potter, A.C. Collop, *A34 mat test: results and analysis*, Cambridge university Engineering Department, Technical Report, CUED/C-MECH/TR61, 1994.
- [3] T. O'Connor, E.J.O'Brien, and B. Jacob, *An experimental investigation of spatial repeatability*, Heavy Vehicle Systems 7 (2000), no. 1, 64–81.
- [4] P. Ullidtz and B.K. Larsen, *Mathematical model for predicting pavement performance*, Transportation Research Board, Record no 949, pp 45-55, Washington D.C., U.S.A, 1983.
- [5] A.C. Collop and D. Cebon, *Parametric study of factors affecting flexible-pavement performance*, Journal of Transportation Engineering (1995), 485–494.
- [6] A.C. Collop, D. Cebon and D.J. Cole, *Effects of spatial repeatability on long –term flexible pavement performance*, Proc. I. Mech. E. (1996), 210, 97-110.
- [7] J. dePont, *Modelling the dynamic wheel forces of the heavy vehicle fleet*, 8th International Symposium of Heavy Vehicle Weights and Dimensions, 2004, South Africa.
- [8] D.J. Cole and D. Cebon, *Spatial repeatability of dynamic tyre forces generated by heavy vehicles*, J. Automobile Engineering, I. Mech. E. (1992), Part D, 206, 17-27.
- [9] J. Eisenmann, *Dynamic wheel load fluctuations-road stress*, Strasse und Autobahn 4, 1975.

- [10] P.F. Sweatman, *A study of dynamic wheel forces in axle group suspension of heavy vehicles*, Special Report No 27, Australian Road Research Board, Melbourne, 1981.
- [11] D. Cebon, *An Investigation of the dynamic Interaction between wheeled vehicles and road surfaces*, PhD dissertation, University of Cambridge, 1985
- [12] S.P. Wilson, N.K. Harris and E.J. OBrien, *The use of Bayesian statistics to predict patterns of spatial repeatability*, Transport Research C – Emerging Technologies, 14(5), 303-315, 2006.
- [13] E.H.L. Aarts and J.H.M. Korst, *Simulated Annealing and Boltzmann Machines*, John Willy and Sons, 1998
- [14] D. Goldberg, *Genetic Algorithms in search, optimization and machine learning*, Addison Wesley, MA, 1989
- [15] L. Shi and S. Olafsson, Nested Partitioning Method for Global Optimization, Manuscript, Department of Industrial Engineering, University of Wisconsin-Madison
- [16] W.B. Gong, Y.C. Ho and W. Zhai., Stochastic comparison Algorithm for Discrete Optimization with Estimation, Proceeding of the 31st IEEE Conference on Decision and Control, 795-800, 1992
- [17] M. Dorigo and G. Di Caro, *The ant Colony optimization metaheuristic*, in D. Corne, M Dorigo and F. Glover (eds.), New ideas in optimization, McGraw-Hill, 11-32, 1999
- [18] R.Y. Rubinstein and D.P. Kroese, *The cross-entropy method : A unified approach to combinatorial optimisation, Monte-Carlo simulation and machine learning*, Springer-Verlag, New York, 2004.
- [19] R.M. Chalasani, *Ride performance potential of active suspension systems part i: Simplified analysis bases on quarter-car models*, Proceeding of the 1986 ASME Winter Annual Meeting (Los Angeles), 1986.
- [20] T.D. Gillespie, *Fundamentals of vehicle dynamics*, Society of Automotive Engineers, Warrendale, 1992.
- [21] J.Y. Wong, *Theory of ground vehicles*, John Willy and Sons, 1993.
- [22] D. Cebon, *Handbook of vehicle-road interaction*, Swets and Zeitlinger Publishers, Lisse, 1999.
- [23] D. Cebon, *Interaction between heavy vehicles and roads*, SAE SP-951.
- [24] S. Türkay and H. Akçay, *A study of random vibration characteristics of the quarter-car model*, Journal of Sound and Vibration **282** (2005), 111–124.
- [25] A. Vrouwenvelder, Zhang Qi-Lin and J. Wardenier, *Dynamic amplification factors and udl of bridges under random traffic flows*, Engineering Structures **237** (2001), 663–672.
- [26] L. Sun and T.W. Kennedy, *Spectral analysis and parametric study of stochastic pavement loads*, Journal of Engineering Mechanics **128** (2002), no. 3, 318–327.
- [27] S. Grave, *Modelling of site-specific traffic loading on short to medium span bridges*, PhD Thesis, Trinity College Dublin, Dublin, 2001.
- [28] D.E. Newland, *An introduction to random vibration and spectral analysis*, 2nd ed, Longman, New York, 1984.
- [29] ISO-8608, *Mechanical vibration-road surface profiles*, Reporting of measured data, 1995(E).
- [30] R.T. Fobes R.P. laBarre and S. Andrew, *The measurement and analysis of road surface roughness*, Motor Industry Research Association Report, No 1970/5.
- [31] H. VanLoo and G. Visser, Vehicle for dynamic calibration of a multiple sensor weigh-in-motion system, 4th International Conference on Weigh-In-Motion – ICWIM4, Eds. E.J. OBrien, B. Jacob, A. Gonzalez & C.-P. Chou, National Taiwan University, 2005, 285-291.

Number	Vehicle parameter	Mean	Standard deviation
1	Unsprung mass, m_u (kg)	420	40
2	Sprung mass, m_s (kg)	4,450	450
3	Suspension stiffness, K_s (N/m)	500,000	50,000
4	Suspension damping, C_s (Ns/m)	21,000	2,000
5	Tyre stiffness, K_t (N/m)	1,950,000	200,000
6	Velocity, v (m/s)	22.43	2.4

Table 1: Vehicle parameters of truck model [24-26]

Variation in fleet property	Objective function	
	-10%	+10%
Mean unsprung mass, m_u	1.63×10^{10}	2.21×10^{10}
Standard deviation of m_u	5.95×10^8	8.19×10^8
Mean sprung mass, m_s	1.15×10^{12}	1.20×10^{12}
Standard deviation of m_s	1.28×10^{10}	1.26×10^{10}
Mean suspension stiffness, K_s	1.47×10^9	2.58×10^9
Standard deviation of K_s	4.56×10^8	7.60×10^8
Mean suspension damping, C_s	3.26×10^9	4.01×10^9
Standard deviation of C_s	8.65×10^8	3.57×10^8
Mean tyre stiffness, K_t	1.38×10^{10}	1.08×10^{10}
Standard deviation of K_t	3.81×10^8	7.67×10^8

Table 2: Sensitivity of objective function to $\pm 10\%$ variations in truck fleet properties

	Target properties	Calculated properties	Difference
Mean unsprung mass, m_u	420	387	-7.9%
Standard deviation of m_u	40	47	17.5%
Mean sprung mass, m_u	4450	4491	0.9%
Standard deviation of m_u	450	490	8.9%
Mean suspension stiffness, K_s	500,000	480,098	-4.0%
Standard deviation of K_s	50,000	52,652	5.3%
Mean suspension damping, C_s	21,000	24,000	14.3%
Standard deviation of C_s	2000	2400	20.0%
Mean tyre stiffness, K_t	1,950,000	1,871,950	-4.0%
Standard deviation of K_t	200,000	180,900	-9.6%

Table 3: Comparison of true (target) truck population parameters with those found by optimisation

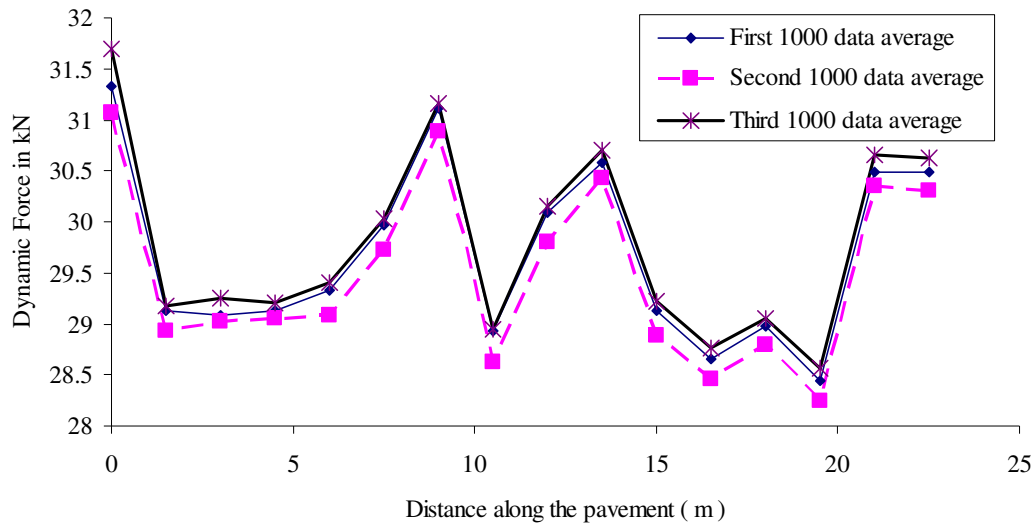

Figure 1: Patterns of stastical spatial repeatability for third axles taken from a fleet of five axle vehicles

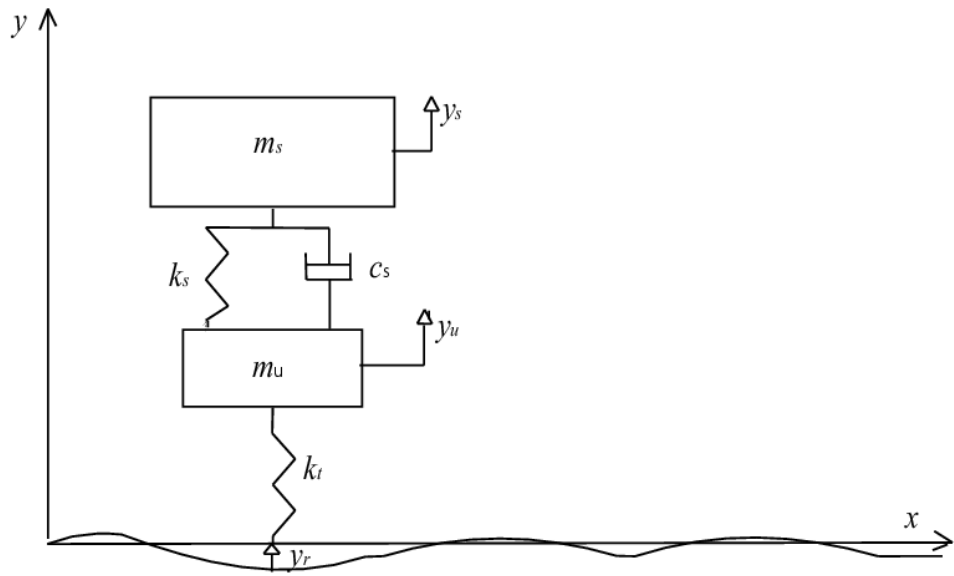

Figure 2: Linear two-degree of freedom quarter car model

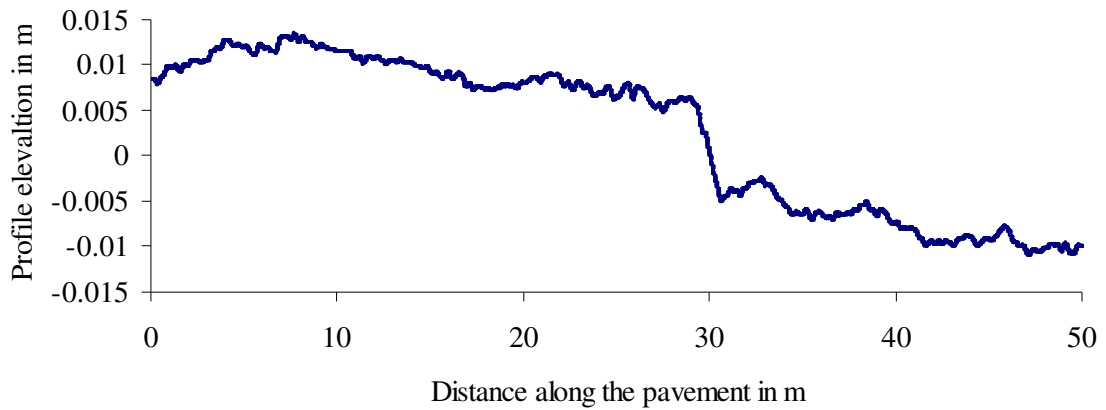
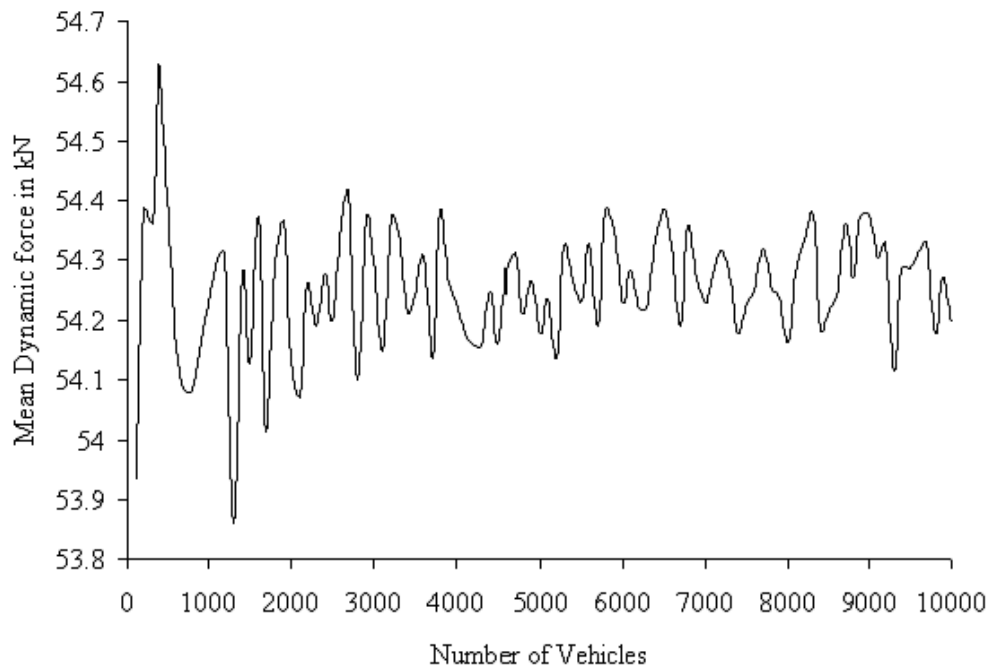
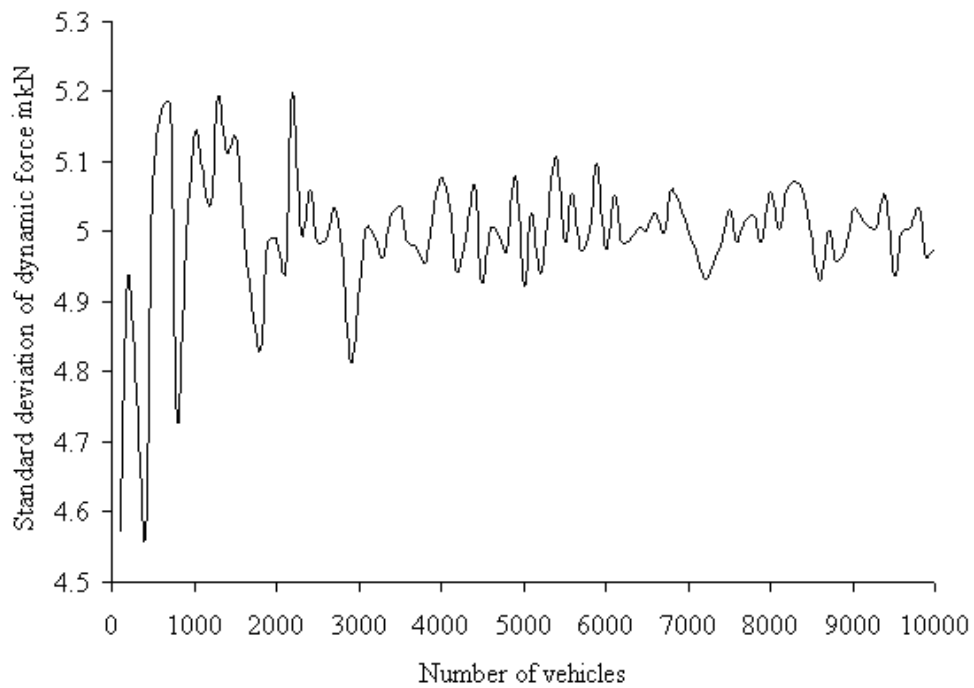

Figure 3: Artificially generated good surface profile (profile 0, Provided as an example for the road profiles mentioned in the paper).



(a)



(b)

Figure 4: Variation in statistics of dynamic force at sensor five with population size: (a) Mean dynamic force; (b) Standard deviation

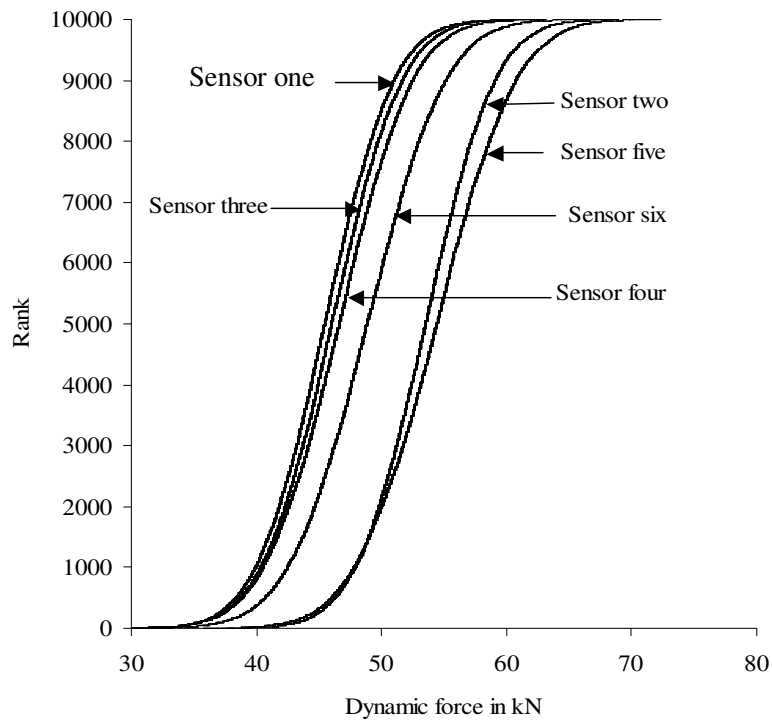

(a)

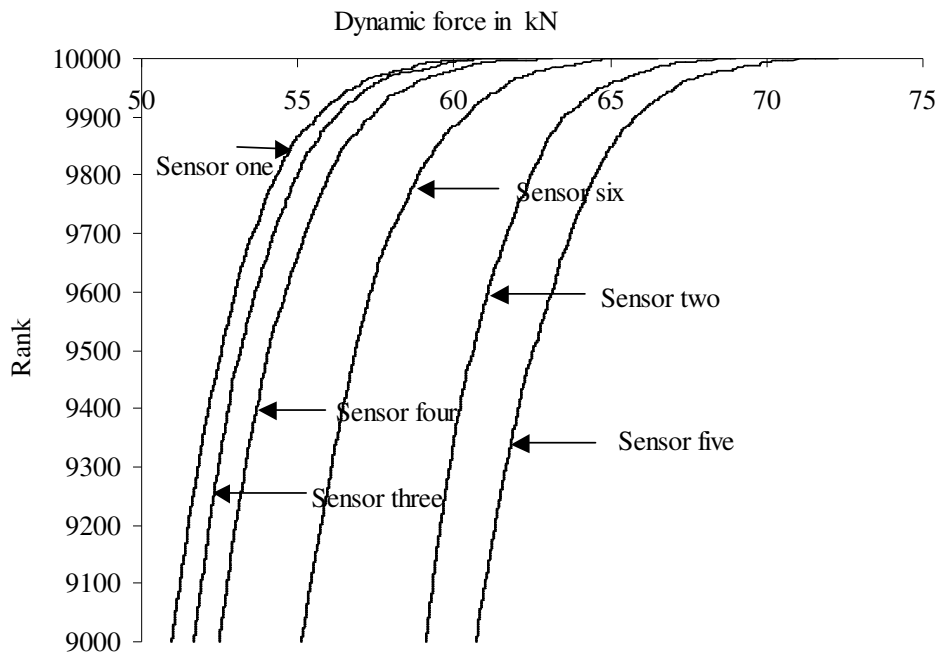

(b)

Figure 5: Cumulative Distribution Function for Dynamic force at six sensor locations: (a) Total cumulative distribution; (b) Top 10% fractile

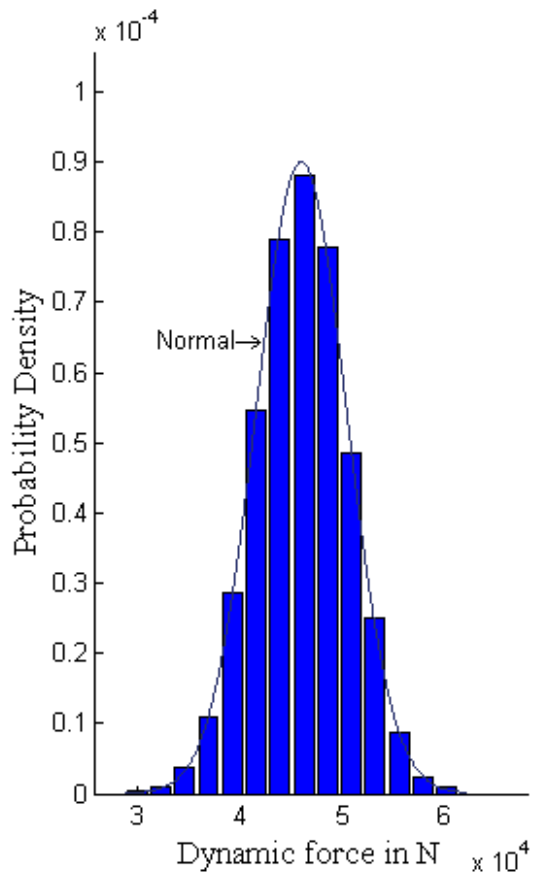
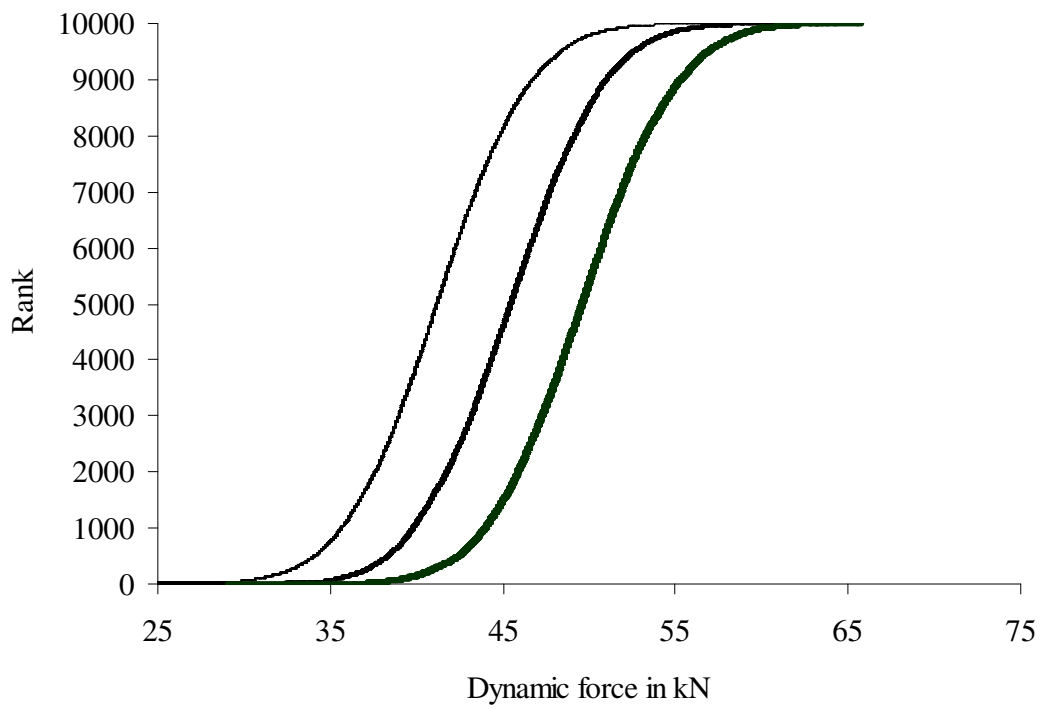
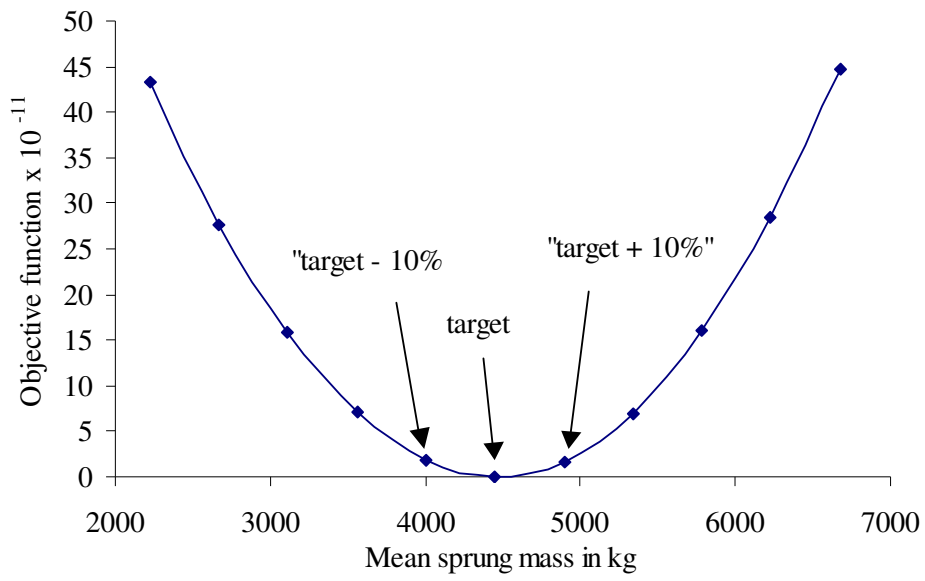

Figure 6: Normal distribution fit to dynamic force at Sensor 1 location.



(a)

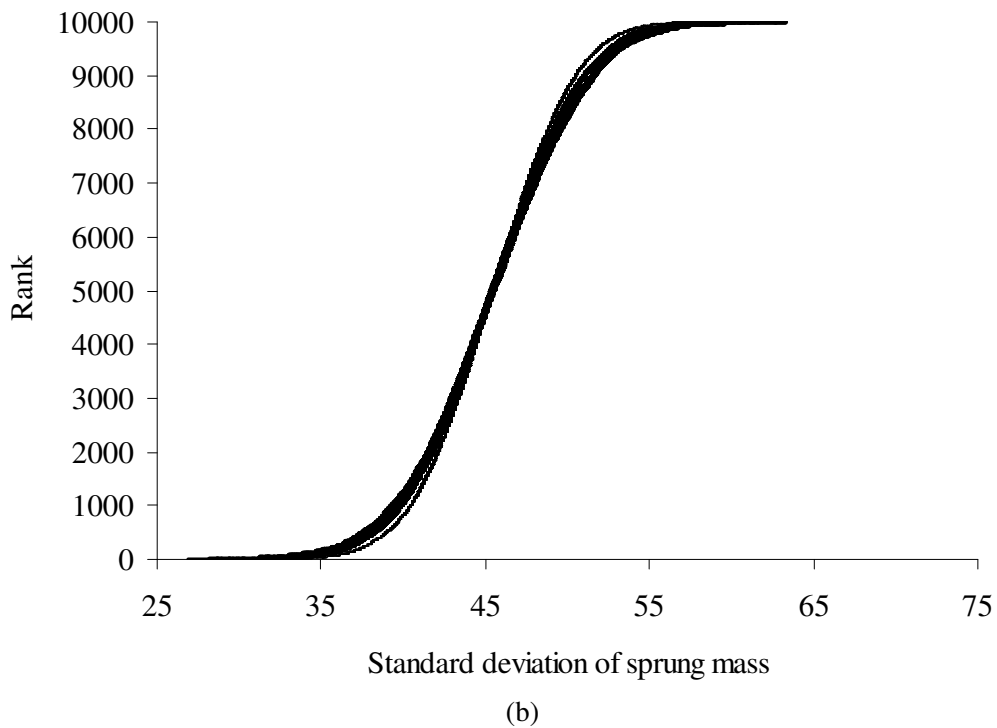
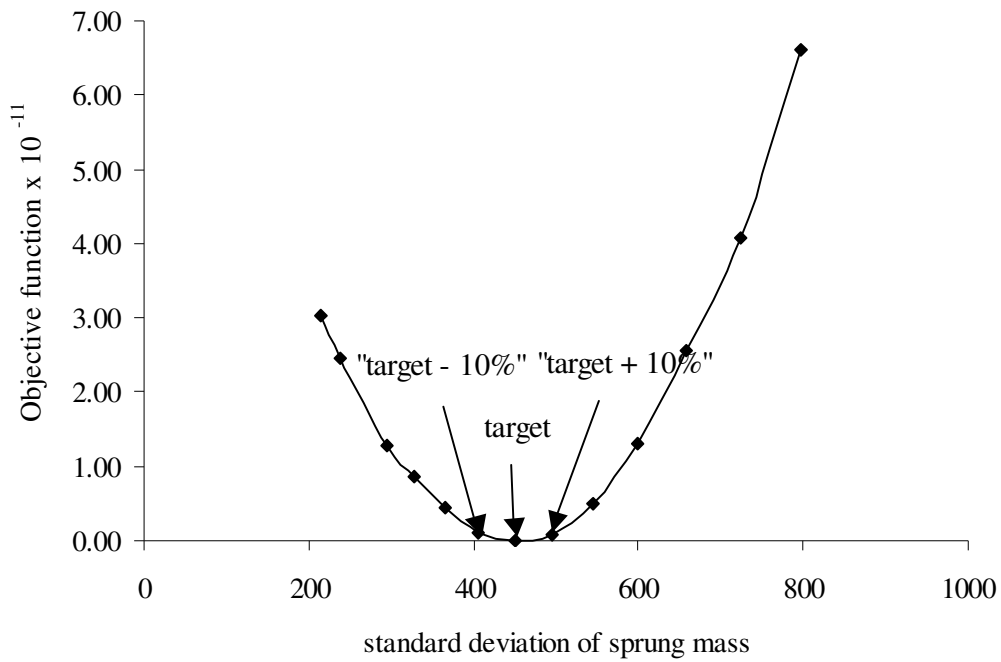
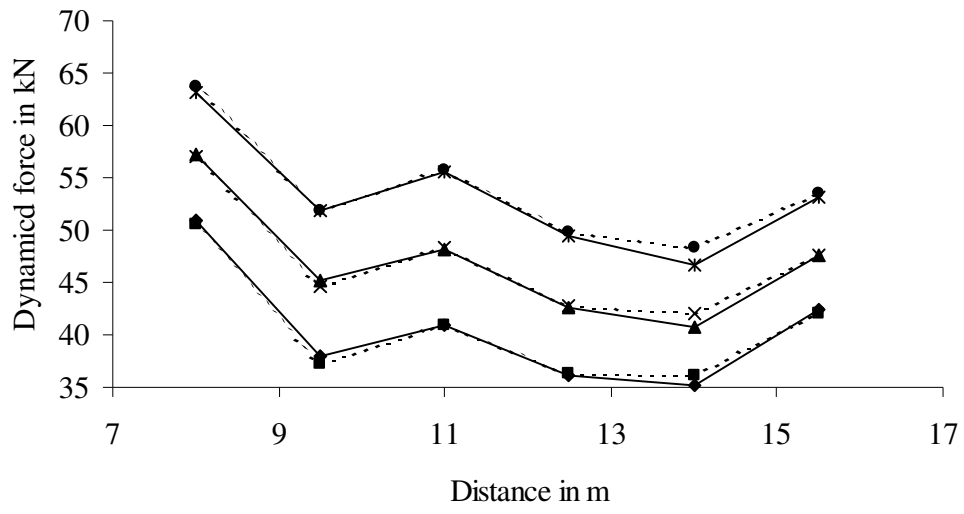
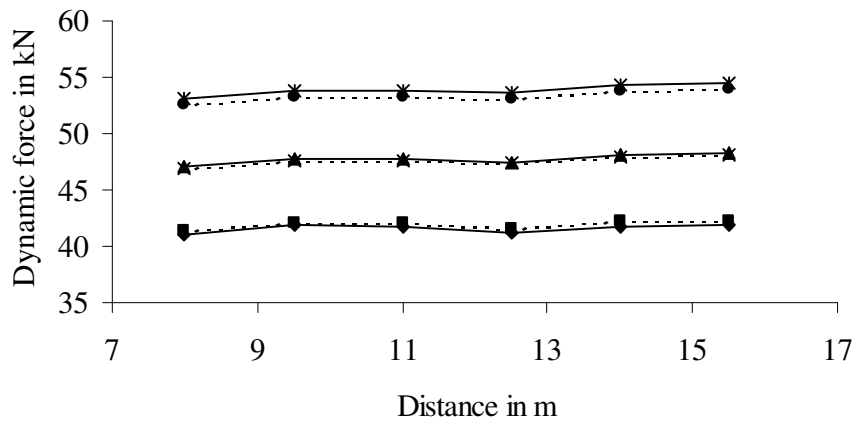

Figure 7: Sensitivity of applied force at Sensor 1 to variations in population properties: (a) Sensitivity to mean sprung mass; (b) Sensitivity to standard deviation of sprung mass (— target - 10%; — target; — target + 10%).



(a)



(b)

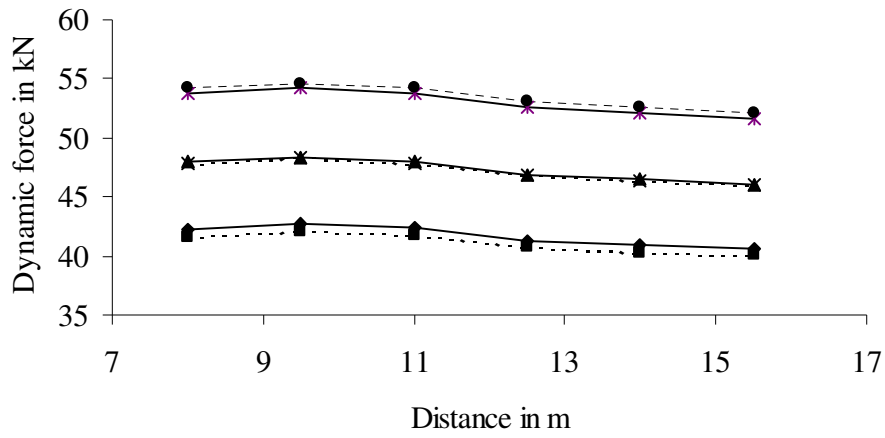

(c)

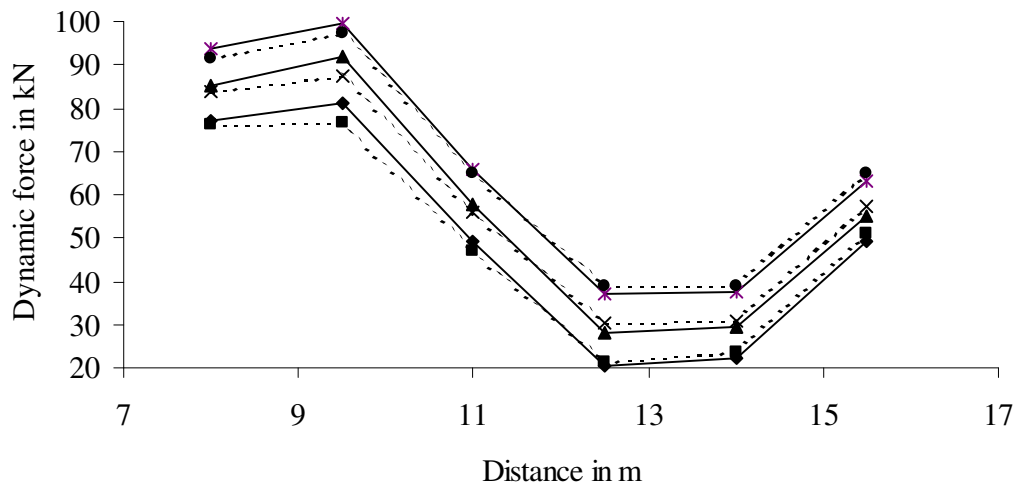

(d)

Figure 8: Comparison between the forces found using the exact fleet properties and the properties found by optimisation: (a) profile 1; (b) profile 2; (c) profile 3; (d) profile 4. (—◆— 10% fractile from exact; ---■--- 10% fractile from optimal; —▲— 50% fractile from exact; ---×--- 50% fractile from optimal; —*— 90% fractile from exact; ---●--- 90% fractile from optimal)